



Features

- Frequency Range 50MHz to 4000MHz
- 5-Bits, 31dB Range, 1dB Step
- High Linearity, IIP3 >48dBm
- 3V and 5V Logic Compatible
- Serial-to-Parallel Controller
- Serial Programming Interface
- Power-up Programming Modes
- On-chip ESD Protection Class 1C HBM
- Single Supply, 3V to 5V Operation
- Footprint Compatible with Most 24-Pin, 4mm x 4mm, QFNs

Applications

- Transceiver RF and IF Applications
- Cellular, PCS, GSM, UMTS, LTE, WiMax/WiFi
- Wireless Data, Satellite Terminals
- Test Equipment

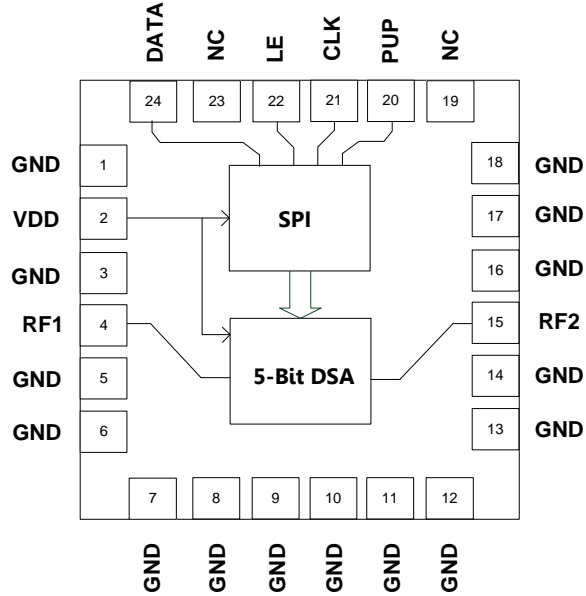

Functional Block Diagram

Product Description

RFMD's RFSA2524 is a 5-bit digital step attenuator (DSA) that features high linearity over the entire 31dB gain control range with excellent step accuracy in 1dB steps. The RFSA2524 is programmed via a serial mode control interface that is both 3V and 5V compatible. The RFSA2524 also offers a rugged Class 1C HBM ESD rating via on-chip ESD circuitry. The MCM package is footprint compatible with most 24-pin, 4mm x 4mm, QFN packages.

Ordering Information

RFSA2524SR	7" reel with 100 pieces
RFSA2524SQ	Sample bag with 25 pieces
RFSA2524TR7	7" reel with 750 pieces
RFSA2524TR13	13" reel with 2500 pieces
RFSA2524PCK-410	50MHz to 4000MHz PCBA with 5-piece sample bag

Optimum Technology Matching® Applied

- | | | | |
|--------------------------------------|--------------------------------------|--|------------------------------------|
| <input type="checkbox"/> GaAs HBT | <input type="checkbox"/> SiGe BiCMOS | <input checked="" type="checkbox"/> GaAs pHEMT | <input type="checkbox"/> GaN HEMT |
| <input type="checkbox"/> GaAs MESFET | <input type="checkbox"/> Si BiCMOS | <input checked="" type="checkbox"/> Si CMOS | <input type="checkbox"/> BiFET HBT |
| <input type="checkbox"/> InGaP HBT | <input type="checkbox"/> SiGe HBT | <input type="checkbox"/> Si BJT | |

RF MICRO DEVICES®, RFMD®, Optimum Technology Matching®, Enabling Wireless Connectivity™, PowerStar®, POLARIS™ TOTAL RADIO™ and UltimateBlue™ are trademarks of RFMD, LLC. BLUETOOTH is a trademark owned by Bluetooth SIG, Inc., U.S.A. and licensed for use by RFMD. All other trade names, trademarks and registered trademarks are the property of their respective owners. ©2012, RF Micro Devices, Inc.

Absolute Maximum Ratings

Parameter	Rating	Unit
Supply Voltage	+5.5	V
DC Supply Current	15	mA
Power Dissipation	83	mW
Max RF Input Power	28.3	dBm
Operating Temperature (T _{CASE})	-40 to +85	°C
Storage Temperature	-40 to +150	°C
Junction Temperature	150	°C
ESD Rating (HBM)	Class 1C	
Moisture Sensitivity Level	MSL3	



Caution! ESD sensitive device.

Exceeding any one or a combination of the Absolute Maximum Rating conditions may cause permanent damage to the device. Extended application of Absolute Maximum Rating conditions to the device may reduce device reliability. Specified typical performance or functional operation of the device under Absolute Maximum Rating conditions is not implied.

The information in this publication is believed to be accurate and reliable. However, no responsibility is assumed by RF Micro Devices, Inc. ("RFMD") for its use, nor for any infringement of patents, or other rights of third parties, resulting from its use. No license is granted by implication or otherwise under any patent or patent rights of RFMD. RFMD reserves the right to change component circuitry, recommended application circuitry and specifications at any time without prior notice.



RFMD Green: RoHS compliant per EU Directive 2002/95/EC, halogen free per IEC 61249-2-21, < 1000ppm each of antimony trioxide in polymeric materials and red phosphorus as a flame retardant, and <2% antimony in solder.

Parameter	Specification			Unit	Condition
	Min.	Typ.	Max.		
Frequency Range	50		4000	MHz	
Insertion Loss		0.68		dB	50MHz, 0dB attenuation
		0.79		dB	500MHz, 0dB attenuation
		0.89		dB	850MHz, 0dB attenuation
		1.26		dB	2100MHz, 0dB attenuation
		1.42		dB	2700MHz, 0dB attenuation
		2.11		dB	4000MHz, 0dB attenuation
Gain Control Range		31		dB	1dB step size
Step Accuracy	±(0.1 + 5.0% attenuation setting)			dB	
Input IP3	48	50		dBm	50MHz to 3000MHz, Min. 48dBm 8dB Bit
Input P0.5dB		26		dBm	50MHz to 100MHz, all states
		28		dBm	150MHz to 2500MHz, all states
Input Return Loss		29		dB	50MHz to 2700MHz, all states
		17		dB	2700MHz to 4000MHz, all states
Output Return Loss		28		dB	50MHz to 2700MHz, all states
		22		dB	2700MHz to 4000MHz, all states
Control Interface	5-bit, Serial			bit	Serial interface
Settling Time		200		ns	t _{RISE} , t _{FALL} (10%/90% RF)
Switching Speed		200		ns	t _{ON} , t _{OFF} (50% CTL to 10%/90% RF)
Supply Voltage (V _{DD})	4.75	5.0	5.25	V	Typical performance based on 5V operation.
Supply Current		5.5		mA	
Control Voltage (V _{CTL})	Low, V _{CTL} = 0V to 0.8V			V	
	High, V _{CTL} = 2.0V to V _{DD}			V	

Notes:

- V_{DD} = 5V, V_{CTL} = 5V, T = 25 °C
- IIP3 measured with P_{IN} = +12dBm/tone, 1MHz spacing

Parameter	Specification			Unit	Condition
	Min.	Typ.	Max.		
Frequency Range	50		4000	MHz	
Insertion Loss		0.75		dB	50MHz, 0dB attenuation
		0.87		dB	500MHz, 0dB attenuation
		0.97		dB	850MHz, 0dB attenuation
		1.35		dB	2100MHz, 0dB attenuation
		1.52		dB	2700MHz, 0dB attenuation
		2.23		dB	4000MHz, 0dB attenuation
Gain Control Range		31		dB	1dB step size
Step Accuracy	±(0.1 + 5.0% attenuation setting)			dB	
Input IP3		35		dBm	50MHz to 100MHz
	46	50		dBm	100MHz to 3000MHz, Min. 46dBm 8dB Bit and 16dB Bit
Input P0.5dB		19		dBm	50MHz to 100MHz, all states
		21		dBm	150MHz to 2500MHz, all states
Input Return Loss		28		dB	50MHz to 2700MHz, all states
		17		dB	2700MHz to 4000MHz, all states
Output Return Loss		27		dB	50MHz to 2700MHz, all states
		22		dB	2700MHz to 4000MHz, all states
Control Interface		5-bit, Serial		bit	Serial interface
Settling Time		200		ns	t _{RISE} , t _{FALL} (10%/90% RF)
Switching Speed		200		ns	t _{ON} , t _{OFF} (50% CTL to 10%/90% RF)
Supply Voltage (V _{DD})	2.8	3.0	3.3	V	Typical performance based on 3V operation.
Supply Current		5.2		mA	
Control Voltage (V _{CTL})	Low, V _{CTL} = 0V to 0.8V			V	
	High, V _{CTL} = 2.0V to V _{DD}			V	

Notes:

- V_{DD} = 3V, V_{CTL} = 3V, T = 25 °C
- IIP3 measured with P_{IN} = +12dBm/tone, 1MHz spacing

Typical Performance at 5V V_{DD} - Broadband Application Circuit

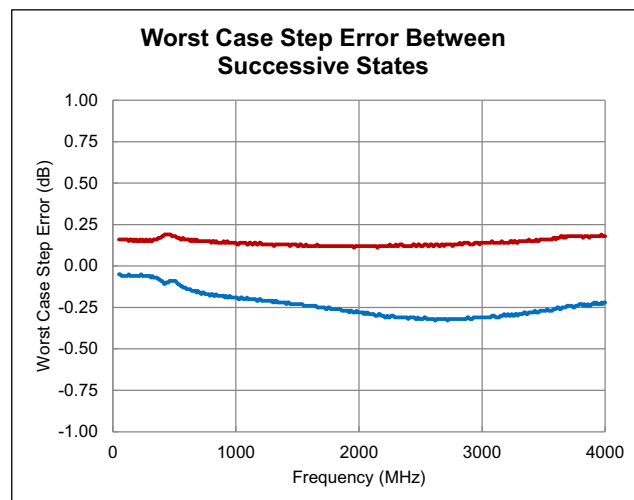
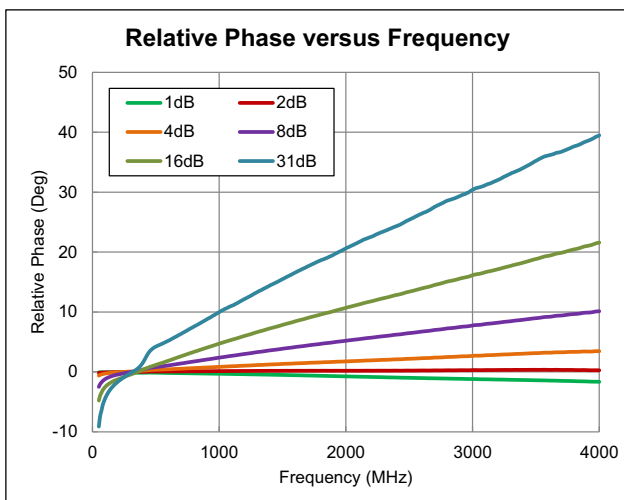
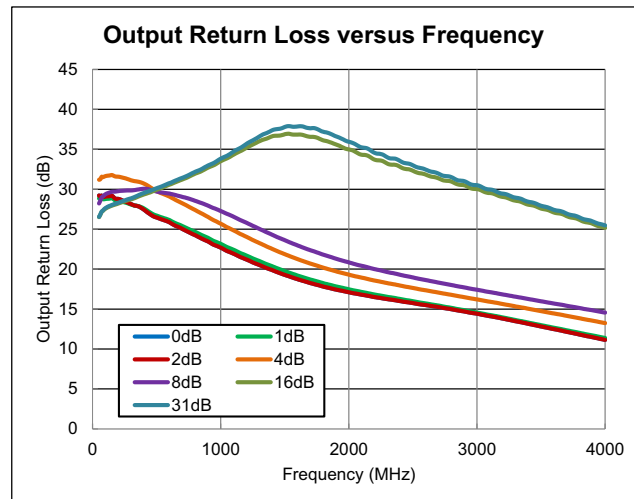
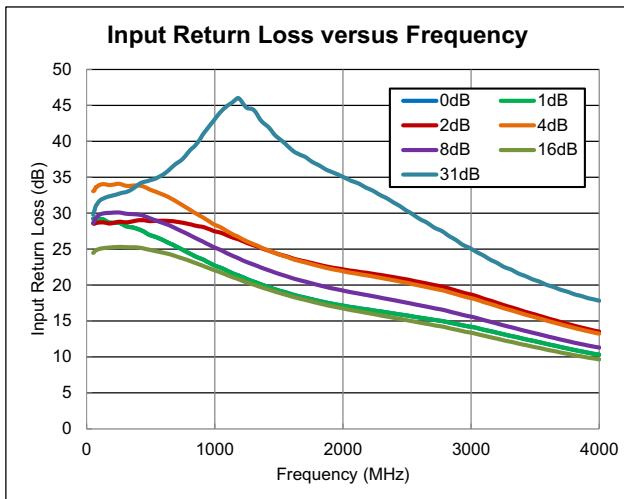
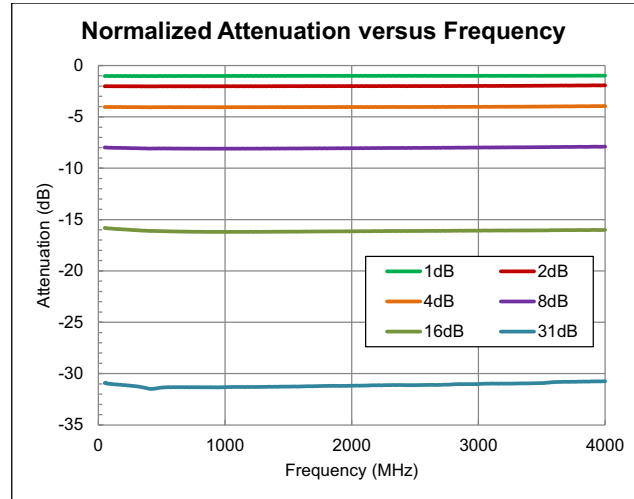
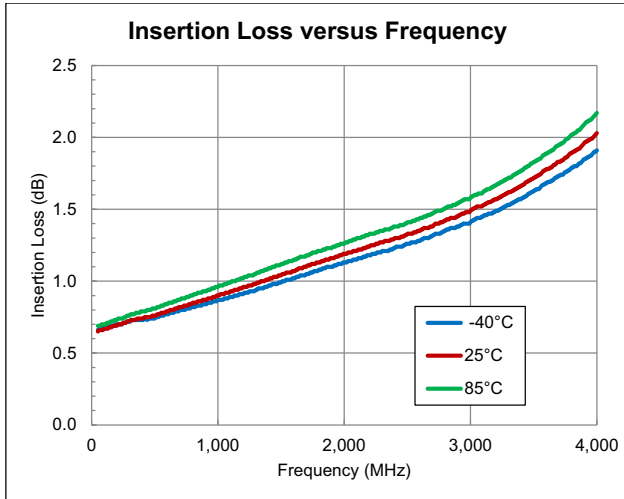

Typical Performance at 5V V_{DD} - Broadband Application Circuit

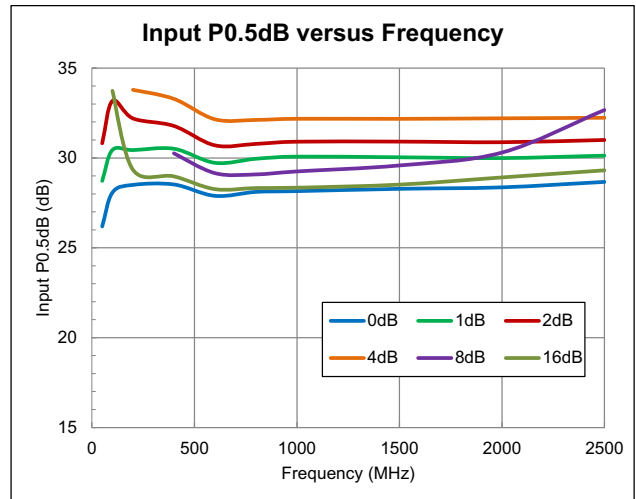
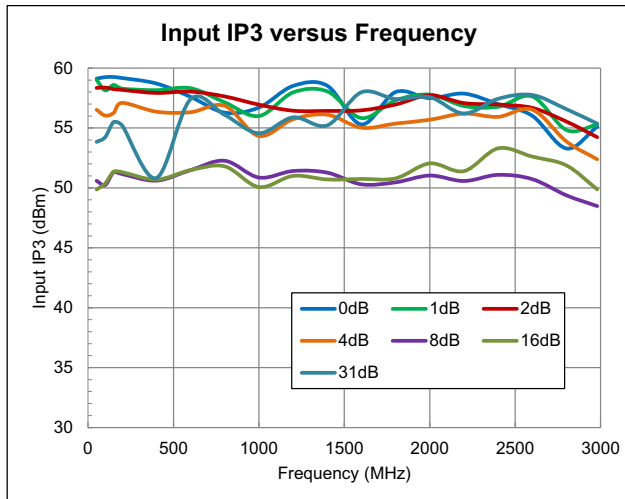
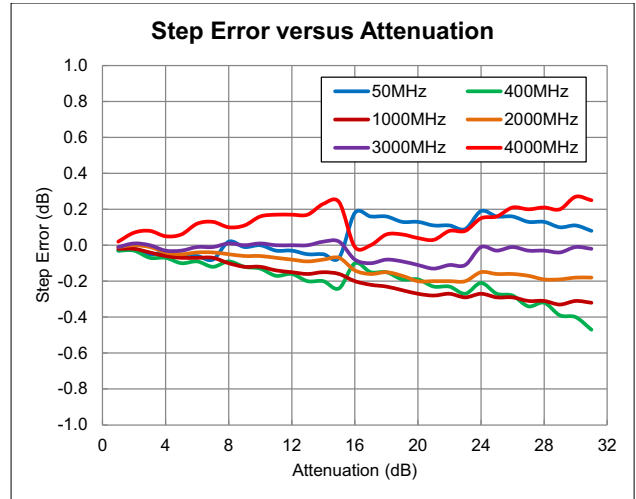
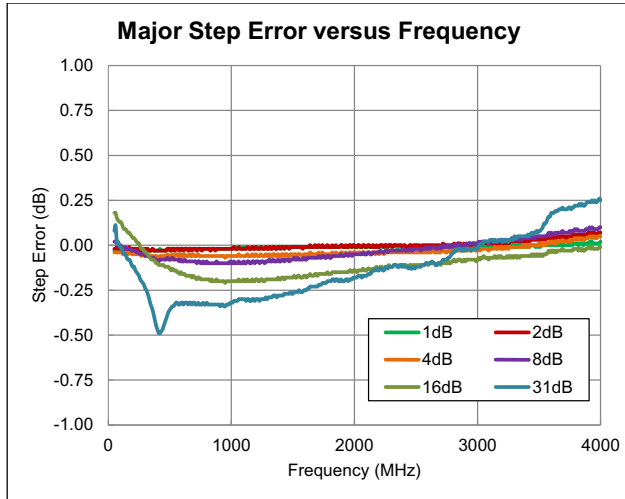

Typical Performance at 3V V_{DD} - Broadband Application Circuit

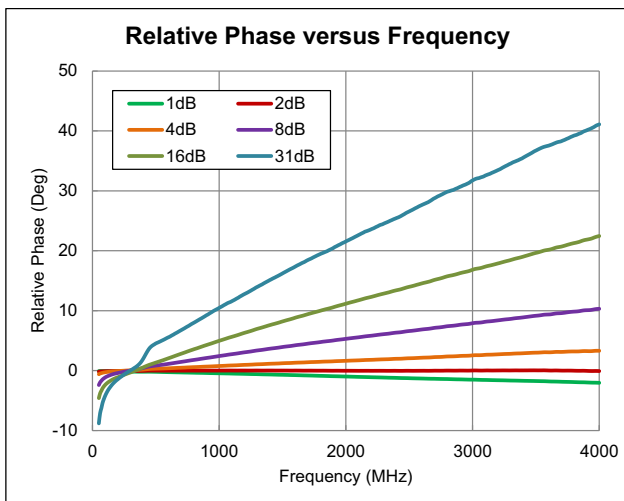
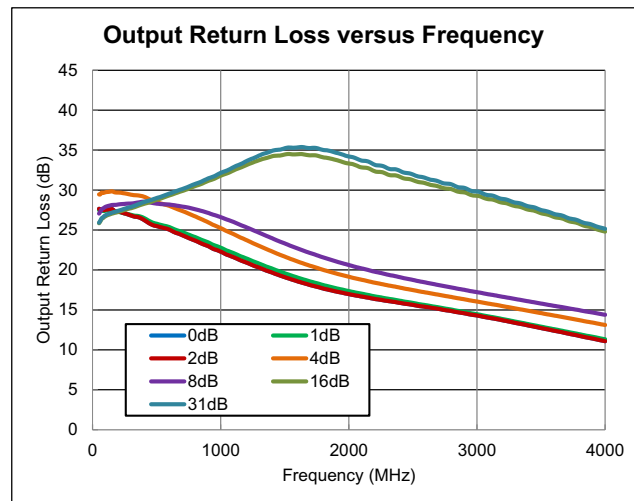
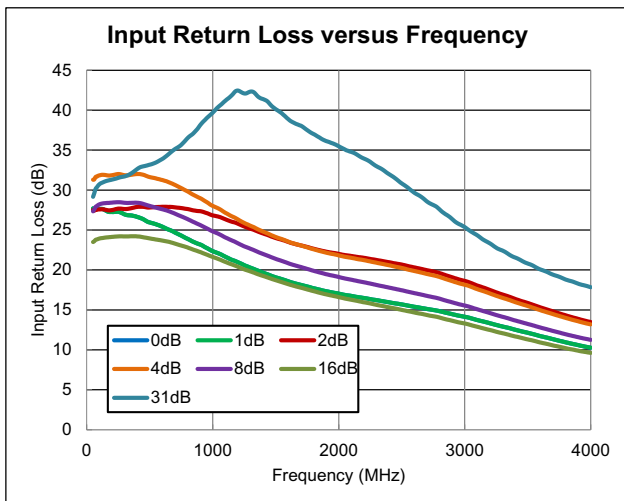
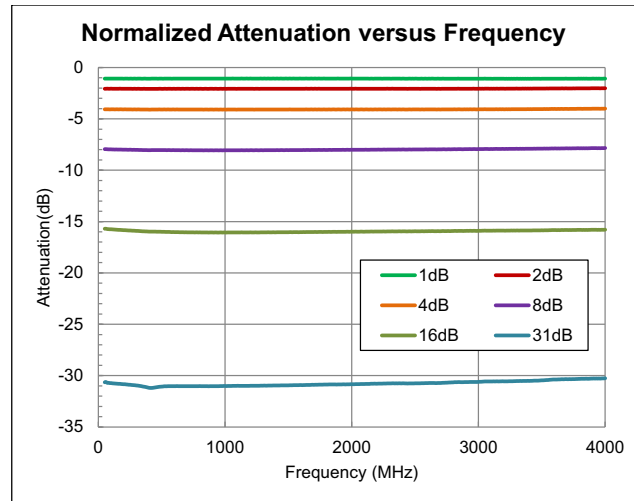
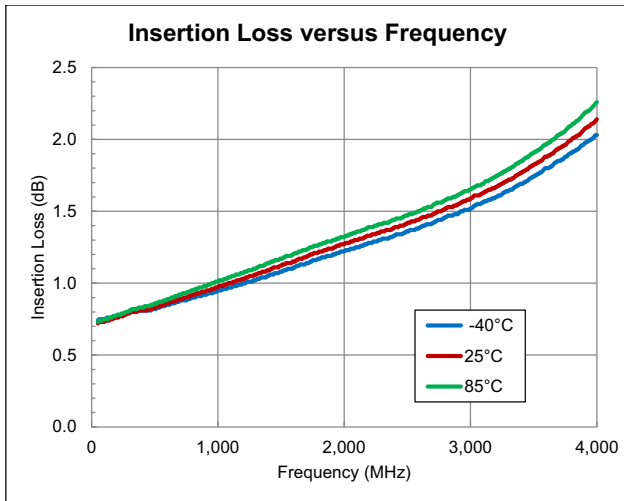

Typical Performance at 3V V_{DD} - Broadband Application Circuit

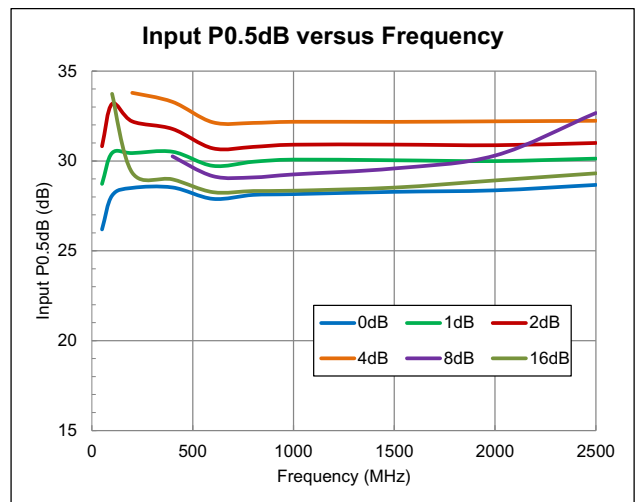
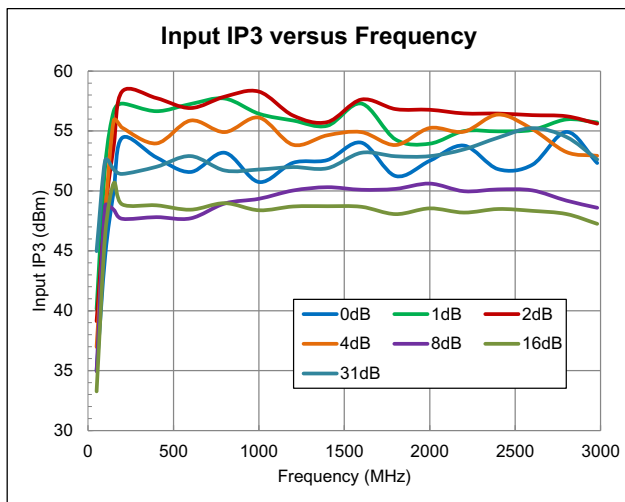
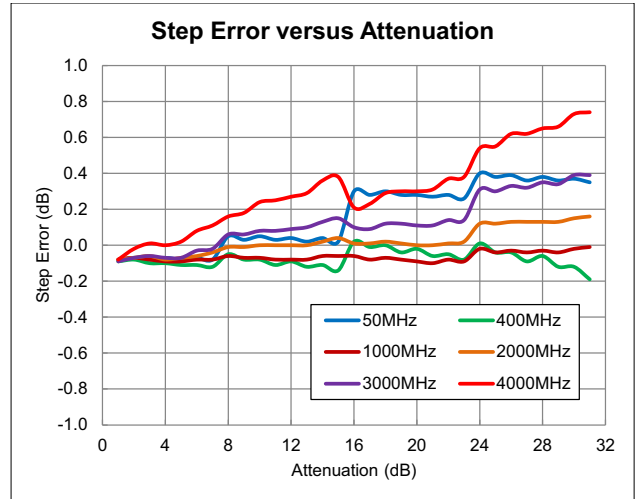
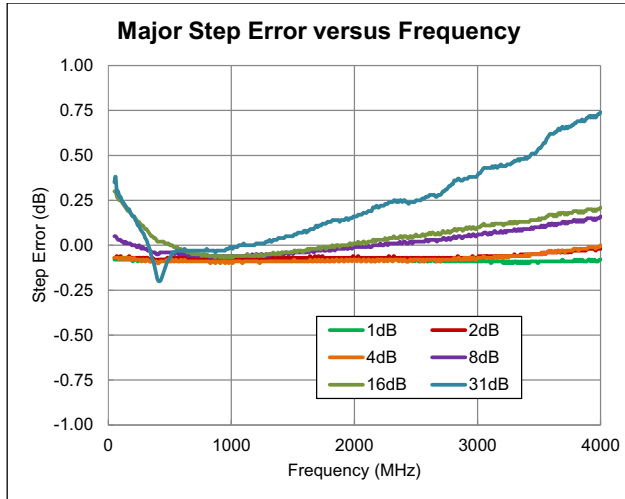

Serial Port Interface

SPI Timing Diagram

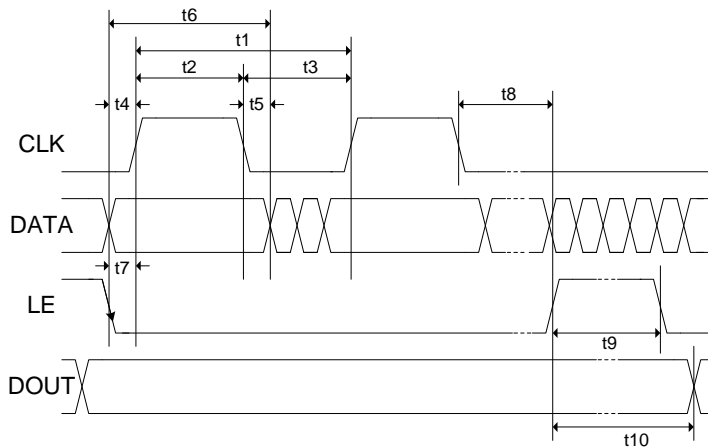

Programming Example - 5-Bit

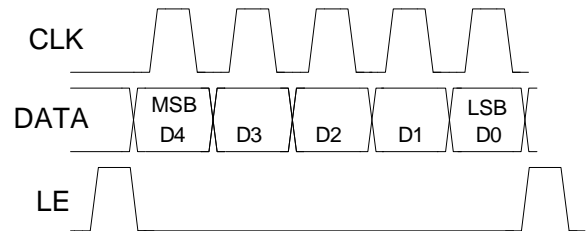

Truth Table

Control Bits					Relative Gain Setting
C16	C8	C4	C2	C1	
1	1	1	1	1	Max gain
1	1	1	1	0	-1dB
1	1	1	0	1	-2dB
1	1	0	1	1	-4dB
1	0	1	1	1	-8dB
0	1	1	1	1	-16dB
0	0	0	0	0	-31dB

SPI Timing Diagram Specifications

Parameter	Limit	Unit	Comment
t1	25	MHz max	CLK Frequency
t2	20	ns min	CLK High
t3	20	ns min	CLK Low
t4	5	ns min	DATA to CLK Setup Time
t5	5	ns min	DATA to CLK Hold Time
t6	30	ns min	Data Valid
t7	5	ns min	LE to CLK Setup Time
t8	5	ns min	CLK to LE Setup Time
t9	10	ns min	LE Pulse Width
t10	20	ns max	Output Set

Logic Voltage Levels	
State	Logic
Low	0V to 0.8V
High	2.0V to 5.0V

Power-up Programming Truth Table	
PUP	Attenuator Setting
Low	Attenuation at max, 31dB
High	Attenuation at min, 0dB

Evaluation Board Schematic

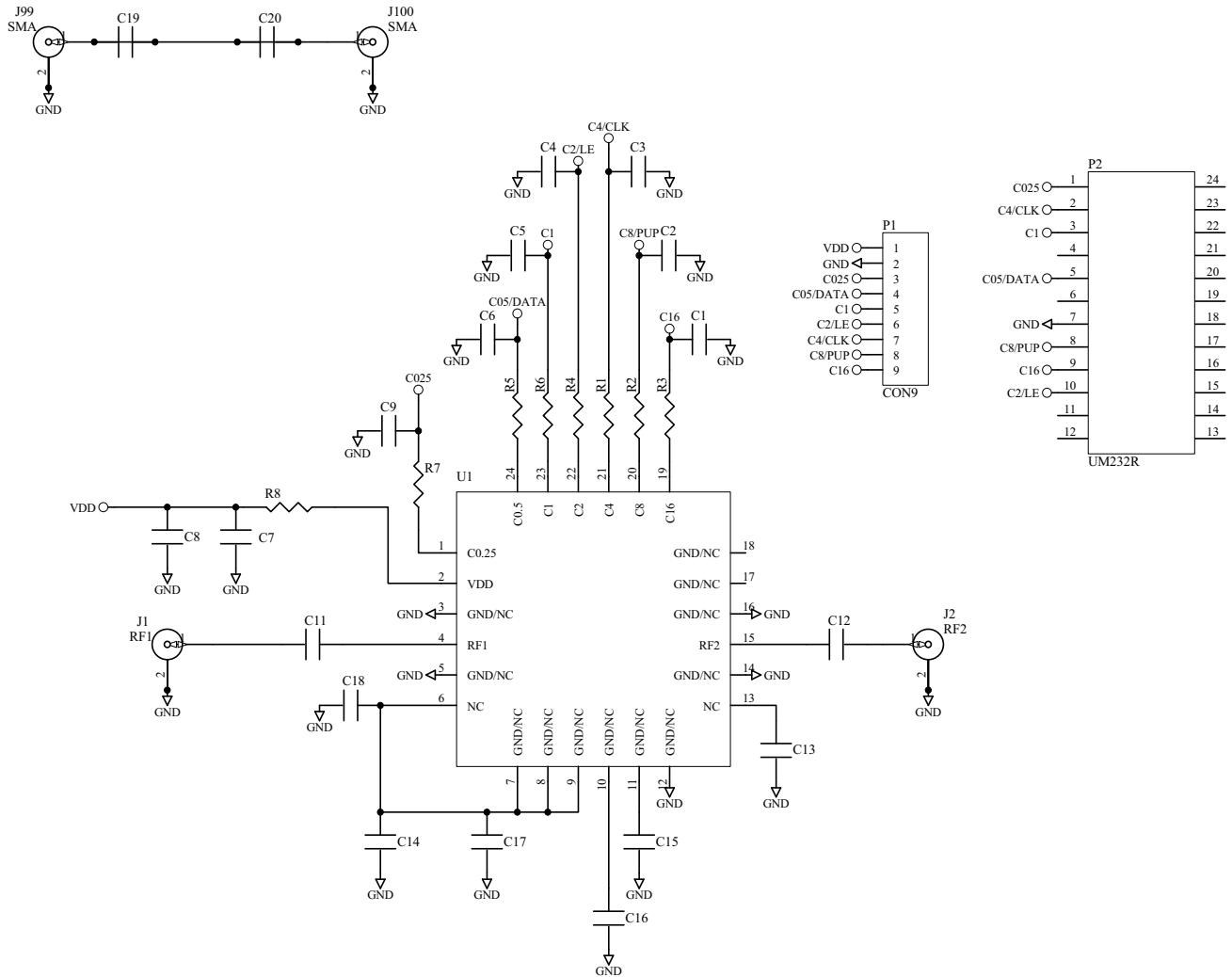

Evaluation Board Bill of Materials (BOM)

Description	Reference Designator	Manufacturer	Manufacturer's P/N
RFSA2714 Evaluation Board	PCB Itself	Dynamic Details (DDI) Toronto	SA2714410(A)
50MHz to 4000MHz, Serial 5-Bit DSA 1dB Step	U1	RFMD	RFSA2524SB
CAP, 10000pF, 10%, 25V, X7R, 0402	C11-C12	Murata Electronics	GRM155R71E103KA01D
CAP, 1000pF, 10%, 50V, X7R, 0402	C7	Taiyo Yuden (USA), Inc.	RM UMK105BJ102KV-F
RES, 0Ω, 0402	R1-R2, R4-R5, R8	Kamaya, Inc	RMC1/16SJPTH
CONN, SMA, END LNCH, UNIV, HYB MNT, FLT	J1-J2, J99-J100	Molex	SD-73251-4000
CONN, HDR, ST, PLRZD, 9-PIN	P1	ITW Pancon	MPSS100-9-C
CONN, SKT, 24-PIN DIP, .600", T/H	P2	Aries Electronics Inc.	24-6518-10
MOD, USB TO SERIAL UART, SSOP-28	M1 (See Note Below)	Future Technology Devices Int'l	UM232R
DNP	C1-C6, C8-C9, C13-C20	NA	NA
DNP	R3, R6- R7	NA	NA

Note: M1 is to be mounted into P2 with respect to the Pin 1 alignment of M1 and P2

Evaluation Board Assembly Drawing

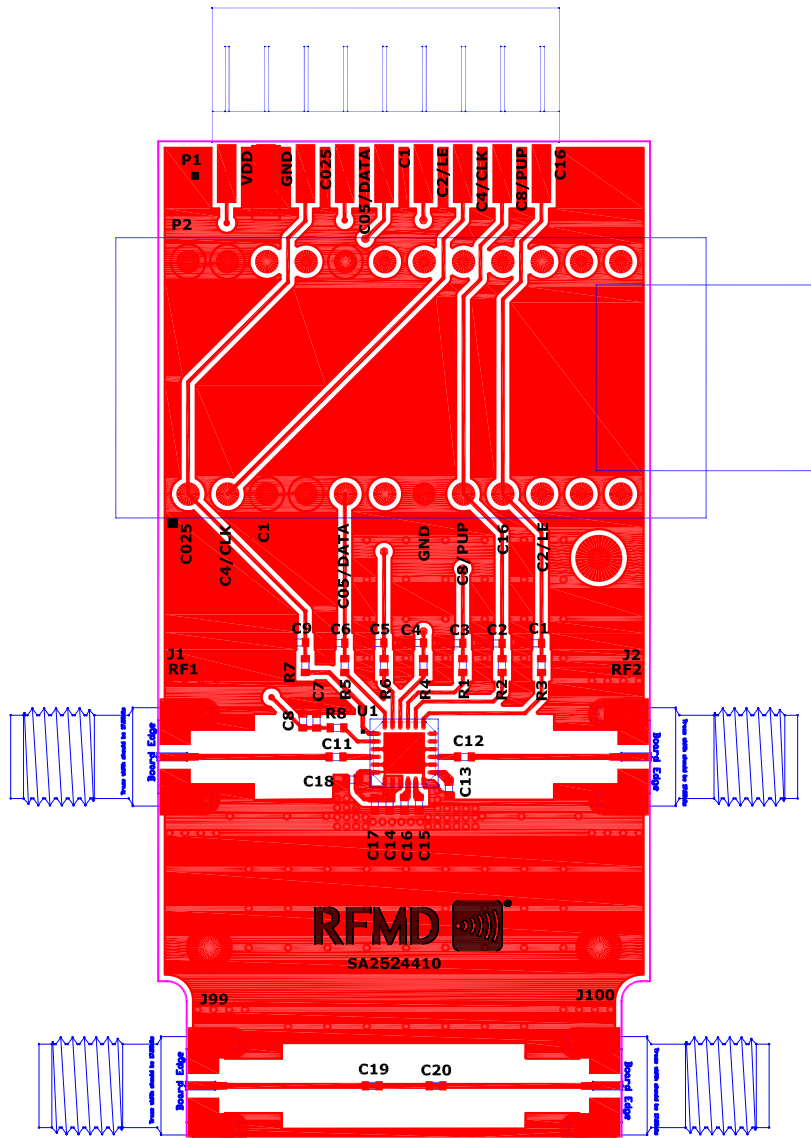

Pin Names and Descriptions

Pin	Name	Description
1	GND	Connect to Low Inductance Path to Ground
2	VDD	Power Supply
3	GND	Connect to Low Inductance Path to Ground
4	RF1	RF port. External DC block required
5	GND	Connect to Low Inductance Path to Ground
6	GND	Connect to Low Inductance Path to Ground
7	GND	Connect to Low Inductance Path to Ground
8	GND	Connect to Low Inductance Path to Ground
9	GND	Connect to Low Inductance Path to Ground
10	GND	Connect to Low Inductance Path to Ground
11	GND	Connect to Low Inductance Path to Ground
12	GND	Connect to Low Inductance Path to Ground
13	GND	Connect to Low Inductance Path to Ground
14	GND	Connect to Low Inductance Path to Ground
15	RF2	RF port. External DC block required.
16	GND	Connect to Low Inductance Path to Ground
17	GND	Connect to Low Inductance Path to Ground
18	GND	Connect to Low Inductance Path to Ground
19	NC	No internal connection. EVB can be ground or no connect
20	PUP	Power-up Programming pin Low = max attenuation (31dB) at power-up High = min attenuation (0dB) at power-up
21	CLK	Serial Clock
22	LE	Latch Enable
23	NC	No internal connection; EVB can be ground or no connect
24	DATA	Serial Data
EPAD	GND	DC and RF Ground; Must be soldered to EVB ground plane over a bed of vias for thermal and RF performance.

Package Drawing

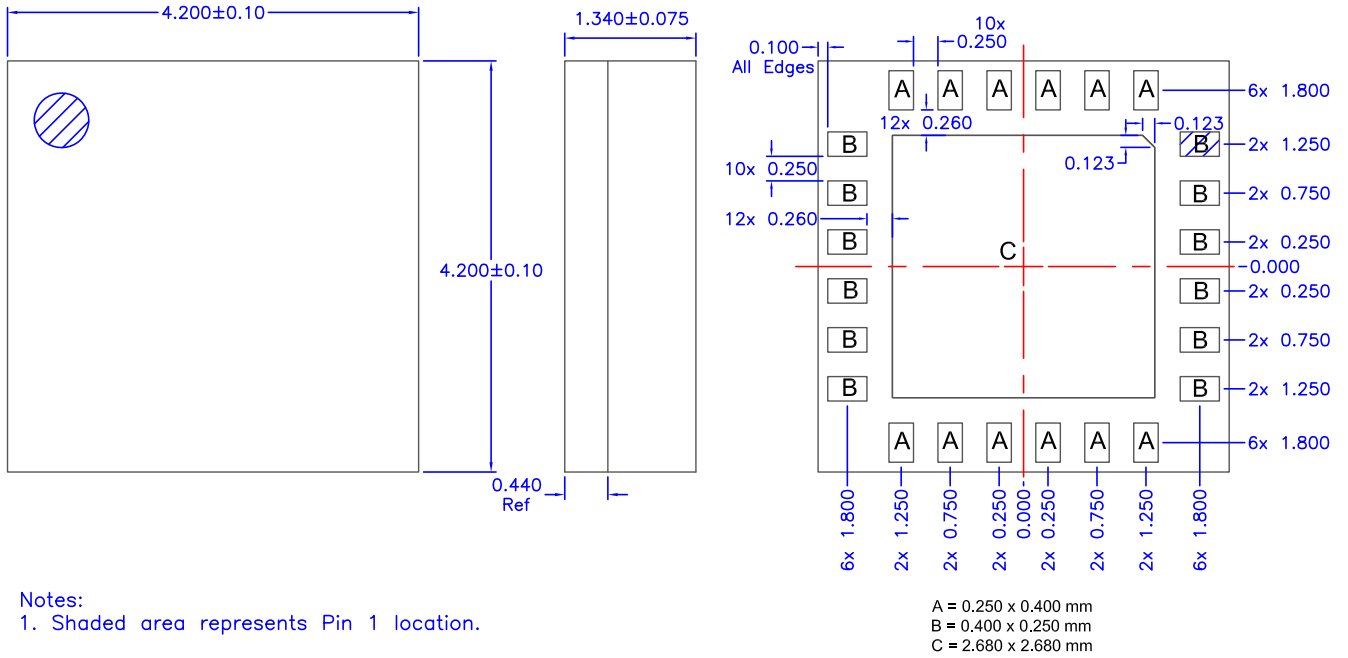

Branding Diagram

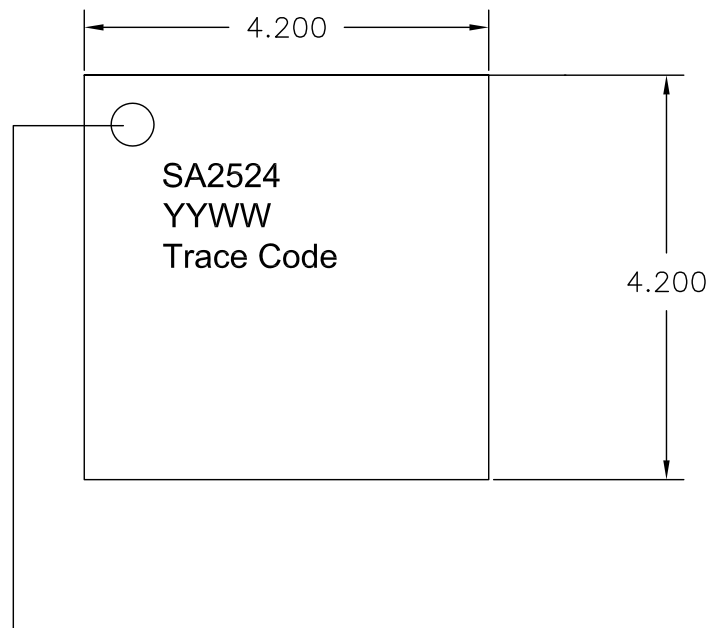

Pin 1 Indicator
YY = Year
WW = Week