



**Features**

- Single-Module Radio Front-End
- Single Supply Voltage 3.0V to 3.6V
- Integrated 2.5GHz & 5GHz PA's, Diplexer LNA for both High and Low Band, Filters & Switches for TX & RX
- P<sub>OUT</sub>=18dBm, 11g, OFDM, <3% EVM and P<sub>OUT</sub>=16dBm, 11a, OFDM, <4% EVM

**Applications**

- IEEE802.11a/b/g/n WiFi Applications
- Single-Chip RF Front-End Module
- 2.5GHz and 5GHz ISM Bands Applications
- WiFi Systems
- Portable Battery-Powered Equipment

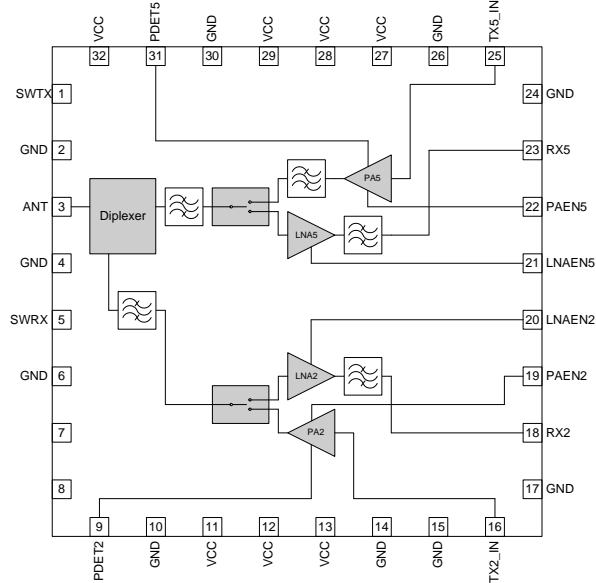

Functional Block Diagram

**Product Description**

The RF5288 is a single-chip dual-band integrated front-end module (FEM) for high-performance WiFi applications in the 2.5GHz and 5GHz ISM bands. The RF5288 addresses the need for aggressive size reduction for a typical 802.11a/b/g RF front-end design and greatly reduces the number of components outside of the core chipset therefore minimizing the footprint and assembly cost of the overall 802.11a/b/g solution. The FEM contains integrated power amplifiers for 2.5GHz and 5GHz, TX/RX switch for each band, low noise amplifier for the 5.0GHz receive band, matching components, bypass capacitors, built-in power detector for both bands, and band pass filters for both transmit paths and some filtering for both receive paths. The device is manufactured on lead frame with InGaP HBT and pHEMT processes. The RF5288 module is a 5mmx5mmx0.9mm package with 32-pins and a backside ground. The RF5288 greatly minimizes next level board space and allows for simplified integration.

**Ordering Information**

RF5288SQ	Standard 25 piece bag
RF5288SR	Standard 100 piece reel
RF5288TR13	Standard 2500 piece reel
RF5288PCK-410	Fully Assembled Evaluation Board with 5 loose sample pieces

**Optimum Technology Matching® Applied**

- |   |                                      |  |                                   |
|---|--------------------------------------|--|-----------------------------------|
| <input type="checkbox"/> GaAs HBT             | <input type="checkbox"/> SiGe BiCMOS | <input checked="" type="checkbox"/> GaAs pHEMT | <input type="checkbox"/> GaN HEMT |
| <input type="checkbox"/> GaAs MESFET          | <input type="checkbox"/> Si BiCMOS   | <input checked="" type="checkbox"/> Si CMOS    | <input type="checkbox"/> RF MEMS  |
| <input checked="" type="checkbox"/> InGaP HBT | <input type="checkbox"/> SiGe HBT    | <input type="checkbox"/> Si BJT                | <input type="checkbox"/> LD MOS   |

RF MICRO DEVICES®, RFMD®, Optimum Technology Matching®, Enabling Wireless Connectivity™, PowerStar®, POLARIS™ TOTAL RADIO™ and UltimateBlue™ are trademarks of RFMD, LLC. BLUETOOTH is a trademark owned by Bluetooth SIG, Inc., U.S.A. and licensed for use by RFMD. All other trade names, trademarks and registered trademarks are the property of their respective owners. ©2006, RF Micro Devices, Inc.

## Absolute Maximum Ratings

Parameter	Rating	Unit
Supply Voltage	-0.3 to +5.4	V <sub>DC</sub>
Power Control Voltage (V <sub>REG</sub> )	-0.5 to +3.5	V
DC Supply Current	400	mA
Input RF Power	0	dBm
Operating Ambient Temperature	0 to +70	°C
Reduced Performance Temps	-30 to 0	°C
	+70 to +85	°C
Storage Temperature	-40 to +150	°C
Moisture Sensitivity	JEDEC Level TBD	



**Caution!** ESD sensitive device.

Exceeding any one or a combination of the Absolute Maximum Rating conditions may cause permanent damage to the device. Extended application of Absolute Maximum Rating conditions to the device may reduce device reliability. Specified typical performance or functional operation of the device under Absolute Maximum Rating conditions is not implied.

RoHS status based on EUDirective2002/95/EC (at time of this document revision).

The information in this publication is believed to be accurate and reliable. However, no responsibility is assumed by RF Micro Devices, Inc. ("RFMD") for its use, nor for any infringement of patents, or other rights of third parties, resulting from its use. No license is granted by implication or otherwise under any patent or patent rights of RFMD. RFMD reserves the right to change component circuitry, recommended application circuitry and specifications at any time without prior notice.

Parameter	Specification			Unit	Condition
	Min.	Typ.	Max.		
<b>2.4GHz Transmit</b>	2.4		2.5	GHz	Nominal Conditions: T=+25 °C, V <sub>CC(b/g)</sub> =3.3V, PAEN_g=2.85V, Freq=2.4GHz to 2.5GHz, unless otherwise noted.
Compliance					IEEE802.11b, IEEE802.11g FCC CFR 15.247, 0.205, 0.209
Output Power 11g	16.5	18		dBm	With a standard IEEE802.11g waveform, OFDM, 54Mbps, 64 QAM, over temperature range -30 °C to +85 °C, and V <sub>CC</sub> =3.0V to 3.6V
EVM					RMS, mean with a standard IEEE802.11g waveform, OFDM, 54Mbps, 64 QAM at 11g rated output power over temperature range -30 °C to +85 °C and V <sub>CC</sub> =3.0V to 3.6V
P <sub>OUT</sub> =18dBm		3	4.5	%	
P <sub>OUT</sub> =14dBm		2	2.5	%	
Output Power 11b	20	21		dBm	With a standard IEEE802.11b waveform, over temperature range -30 °C to +85 °C, and over V <sub>CC</sub> =3.0V to 3.6V
Adjacent Channel Power					At 11b rated output power with 1Mbps and 11Mbps 11b waveform over temperature range -30 °C to +85 °C, and over V <sub>CC</sub> =3.0V to 3.6V
ACP1		-38	-30	dBc	
ACP2		-56	-50	dBc	
Gain	25	27		dB	
Gain Variance	-2.5		+2.5	dB	Over Temperature range -10 °C to +70 °C and over Frequency
Power Detect					
Voltage Range	0.8	0.95	1.2	V	At 20dBm
	0.2	0.25	0.35	V	At 10dBm P <sub>OUT</sub>
Output Resistance		10		kΩ	
Output Capacitance		10		pF	
Power Detector Accuracy	-1.5		+1.5	dB	Into 3:1 VSWR
Sensitivity					
>14dBm		75		mV/dB	
0 < P <sub>OUT</sub> < 14dBm		25		mV/dB	

Parameter	Specification			Unit	Condition	
	Min.	Typ.	Max.			
<b>2.4GHz Transmit, cont.</b>						
Current Operating		125	160	mA	RF P <sub>OUT</sub> =14dBm, 54Mbps, IEEE802.11g	
		160	230	mA	RF P <sub>OUT</sub> =18dBm, 11Mbps, IEEE802.11b	
		200	275	mA	RF P <sub>OUT</sub> =20dBm, 11g or 11b	
Quiescent		90	125	mA	V <sub>CC</sub> =ON, PAEN=ON, RF=OFF	
PAEN		75	100	uA	Over full temp range and V <sub>REG</sub>	
Shutdown		5	10	uA	Voltage range PAEN≤0.2V	
Second Harmonic					P <sub>OUT</sub> =20dBm, 1Mbps, 11b mode	
	Second		-49	-45	dBm	4.90GHz to 5.00GHz
	Third		-46	-43	dBm	7.20GHz to 7.50GHz
Power Supply	3.0	3.3	3.6	V		
PAEN Voltage						
	ON	2.0	3.0	3.2	V	TTL, 200mV less than V <sub>CC</sub>
	OFF		0	0.2	V	
Input Return Loss			-12	-9	dB	
Ruggedness Output VSWR	10:1				ratio	No damage, conditions: max operating voltage, max input power
Stability Output VSWR	4:1				ratio	
Turn-On/Off Time		0.5	1.0	μS		Output stable to within 90% of final gain, Note 1
<b>5.0GHz Transmit</b>						
Compliance						IEEE802.11a IEEE802.11j FCC CFR 15.247, 0.205, 0.209
Frequency						Nominal Conditions: T=+25°C, V <sub>CC</sub> =3.3V, PAEN=3.0V, Freq range from 4.9GHz to 5.85GHz unless otherwise noted.
	Band 1	4.9		5.1	GHz	
	Band 2	5.10		5.35	GHz	
	Band 3	5.35		5.65	GHz	
	Band 4	5.65		5.825	GHz	
Band 1 P <sub>OUT</sub>		11.5	13		dBm	RMS, mean with a standard IEEE802.11g waveform, OFDM, 54Mbps, 64 QAM V <sub>CC</sub> =3.3V <sub>DC</sub> , 0°C to +70°C over beta
EVM		2	3		%	
Band 2 P <sub>OUT</sub>		11.5	13		dBm	
EVM		2	2.5		%	
Band 3 P <sub>OUT</sub>		11.5	13		dBm	
EVM		2	2.5		%	
Band 3 P <sub>OUT</sub>		14.5	16		dBm	
EVM		3	4		%	
Band 4 P <sub>OUT</sub>		11.5	13		dBm	
EVM		2	2.5		%	
Band 4 P <sub>OUT</sub>		14.5	16		dBm	
EVM		3	4		%	
Band 4 P <sub>OUT</sub>		16.5	18		dBm	
EVM		4	7		%	

Parameter	Specification			Unit	Condition
	Min.	Typ.	Max.		
<b>5.0GHz Transmit, cont.</b>					
Gain	26	28		dB	
Gain Variance	-2		+2	dB	
Power Detect					
Voltage Range	0.8	0.9	1.0	V	At 18dBm P <sub>OUT</sub>
	0.4	0.5	0.6	V	At 10dBm P <sub>OUT</sub>
Output Resistance		TBD		kΩ	
Output Capacitance		TBD		pF	
Power Detector Accuracy	-1		+1	dB	At 3.0:1 VSWR at all Phases, power and all conditions
Sensitivity					
>10dBm		20		mV/dB	1V to 0.5V
0 < P <sub>OUT</sub> < 10dBm		10		mV/dB	0V to 0.5V
Current Operating		180		mA	RF P <sub>OUT</sub> =18dBm, 54Mbps, 11a
		100		mA	RF P <sub>OUT</sub> =13dBm, 54Mbps, 11a
Quiescent			10	mA	V <sub>CC</sub> =ON, PAEN=ON, RF=OFF
PAEN		TBD		μA	PAEN<0.2V
Shutdown		85		μA	
V <sub>CC</sub> , Supply Voltage	3.0	3.3	3.6	V	
PAEN Voltage					
ON	2.8	3.0	3.2	V	TTL, 200mV less than V <sub>CC</sub>
OFF		0	0.2	V	
Input Impedance		50	2:1	Ω	
Max Input Power Operational			-5	dBm	
Rated Input Power Withstand			0	dBm	No damage.
Ruggedness Output VSWR	10:1			ratio	No damage, conditions: max operating voltage, max input power
Stability Output VSWR	4:1			ratio	
Harmonics					
Second Band 2			-36	dBm	P <sub>OUT</sub> =13dBm in 1MHz RBW @ 6Mbps
Second Band 3			-48	dBm	P <sub>OUT</sub> =16dBm in 1MHz RBW @ 6Mbps
Second Band 4			-48	dBm	P <sub>OUT</sub> =18dBm in 1MHz RBW @ 6Mbps
Third All Bands			-48	dBm	Rated power in 1MHz RBW @ 6Mbps
Turn-On/Off Time			1.0	μS	Output stable to within 90% of final gain, Note 1

Parameter	Specification			Unit	Condition
	Min.	Typ.	Max.		
<b>2.4GHz Receive</b>					
Compliance					IEEE802.11a IEEE802.11j FCC CFR 15.247, 0.205, 0.209
Frequency	2.4		2.5	GHz	
Switch Leakage		2	6	μA	SW=High
Output Impedance 50Ω		-10	-9	dB	
Low Band LNA Enable Current		60	100	uA	
Enable Voltage	2.8	3	3.2	V	TLL, 200mV less than V <sub>CC</sub>
<b>High Gain Mode</b>					
					SWRX=1, LNA2EN=1, SWTX=0
RX Gain	10	12	14	dB	
RX Gain Variation	-1.5		+1.5	dB	Over frequency range, full temperature range, and voltage
Noise Figure		3	3.2	dB	Across frequency
Input P1dB**	-4	-1		dBm	
Input IIP3		12			2-tone, P <sub>IN</sub> =-20dBm, Δf=1MHz
Current Consumption		12	20	mA	
<b>Low Gain Mode 1</b>					
					SWRX=1, LNA2EN=1, SWTX=1
RX Gain	-2	0	+2		
Noise Figure		16		dB	Across frequency
Input P1dB		8		dBm	
IIP3		21		dBm	2-tone, P <sub>IN</sub> =-13dBm, Δf=1MHz
Current Consumption		16	20	mA	
<b>Low Gain Mode 2</b>					
					SWRX=0, LNA2EN=1, SWTX=1
RX Gain	-19	-17	-15	dB	
Noise Figure		33			
Input P1dB		25		dBm	
IIP3		38		dBm	2-tone, P <sub>IN</sub> =-15dBm, Δf=1MHz
Current Consumption		16	20	mA	
<b>Low Gain Mode 3</b>					
					SWRX=1, LNA2EN=0, SWTX=1
RX Gain	-43	-41	-39	dB	
Noise Figure		41		dB	
IIP3		TBD			
Current Consumption		0		mA	

Parameter	Specification			Unit	Condition
	Min.	Typ.	Max.		
<b>5.0GHz Receive</b>					
Compliance					IEEE802.11a IEEE802.11j FCC CFR 15.247, 0.205, 0.209
Frequency	4.9		5.9	GHz	
Switch Leakage		2	6	μA	SW2=High
Output Impedance 50Ω		2.0:1		Ratio	
Passband Ripple		±1		dB	
<b>High Gain Mode</b>					
					SWRX=1, LNA5EN=1, SWTX=0
RX Gain	9	11	13	dB	P <sub>IN</sub> to P <sub>IN</sub>
RX Gain Variation	-1.5		+1.5	dB	Over frequency range, full temperature range, and voltage
Noise Figure		2.7	3.0	dB	25 °C
Input P1dB	-5	-2		dBm	
IIP3		12			2-tone, P <sub>IN</sub> =-20dBm, Δf=1MHz
Current Consumption		15	20	mA	
<b>Low Gain Mode 1</b>					
					SWRX=0, LNA5EN=1, SWTX=0
RX Gain	1	3	5	dB	
Noise Figure		11		dB	
Input P1dB		7		dBm	
IIP3		18.5		dBm	2-tone, P <sub>IN</sub> =-15dBm, Δf=1MHz
Current Consumption		17	20	mA	
<b>Low Gain Mode 2</b>					
					SWRX=1, LNA5EN=0, SWTX=0
RX Gain	-33	-31	-29	dB	
Noise Figure		31		dB	
Input P1dB		16		dBm	
IIP3		21		dBm	2-tone, P <sub>IN</sub> =-5dBm, Δf=1MHz
Current Consumption		0		mA	
<b>Other Requirements</b>					
Antenna Port Impedance					
	Input		50	Ω	Receive
	Output		50	Ω	Transmit
ESD Protection on Antenna Port	6			kV	No change in performance
ESD Protection on All Other Pins					
	Human Body Model	500		V	No change in performance
	Machine Model	500		V	No change in performance
Isolation					
Low Band RX - Off Antenna	17	20		dB	Low band transmit mode
High Band RX - Off Antenna	20	25		dB	High band transmit mode, LNA off
Total Module Leakage, V <sub>CC</sub> , SW1, and SW2		5	15	uA	V <sub>CC</sub> =SW1=SW2=3.6V PAEN2 and 5=LNAEN2 and 5=0.2V

Pin	Function	Description
1	SWTX	Switch control port. See truth table for details.
2	GND	Ground connection.
3	ANT	RF TX output for the 802.11b/g/a paths. It is matched to 50Ω and the DC block is provided internally.
4	GND	Ground connection.
5	SWRX	Switch control port. See truth table for details.
6	GND	Ground connection.
7	N/C	Pin 7 and Pin 8 have to be connected together on the PCB, but should not be connected to anything else on the board, see schematic for details.
8	N/C	Pin 7 and Pin 8 have to be connected together on the PCB, but should not be connected to anything else on the board.
9	PDET2	Power detector voltage for the 802.11b/g PA. P <sub>DET</sub> voltage varies with output power. May need external decoupling capacitor for module stability. May need resistive voltage divider to bring output voltage to desired level.
10	N/C	No connection.
11	VCC	Main supply voltage for the third stage of the b/g power amplifier. This pin requires an external bypass capacitor.
12	VCC	Both pins 12 and 13 are the main supply voltage for the first and second stages of the b/g power amplifier. It is recommended that both pins 12 and 13 be connected on the PCB right at the footprints of these pins. Both pins require one bypass capacitor. See schematic for more details.
13	VCC	See pin 12 for details.
14	GND	Ground connection.
15	GND	Ground connection.
16	TX2_IN	RF input for the 802.11b/g PA. Input is matched to 50Ω and DC block is provided internally.
17	GND	Ground connection.
18	RX2	Receive port for 802.11b/g band.
19	PAEN2	Bias voltage for the 802.11b/g PA. Internally decoupled port with approximately 100 pF.
20	LNAEN2	Bias voltage for the 802.11b/g LNA.
21	LNAEN5	Bias voltage for the 802.11a LNA.
22	PAEN5	Bias voltage for the 802.11a PA. Internally decoupled port with approximately 100 pF.
23	RX5	Receive port for 802.11a band.
24	GND	Ground connection.
25	TX5_IN	TX RF input for the 802.11a PA. Input is matched to 50Ω and DC block is provided internally.
26	GND	Ground connection.
27	VCC	Main voltage supply for the first and second stages for the 11a power amplifier. This pin requires a bypass capacitor externally.
28	VCC	This pin requires a 1μF to ground. This pin is internally connected to VCC and should not be connected to VCC externally.
29	VCC	Main voltage supply to the third stage of the 11a power amplifier. This pin requires a bypass capacitor externally.
30	N/C	No Connect.
31	PDET5	Power detector voltage for the 802.11a PA. P <sub>DET</sub> voltage varies with output power. May need external decoupling capacitor for module stability. May need resistive voltage divider to bring output voltage to desired level.
32	VCC	Main voltage supply.
Pkg GND	GND	Ground connection. The back side of the package should be connected to ground plane through as short a connection as possible, e.g., PCB vias under the device are recommended.

### Switch Truth Table

PAEN2	LNA_EN2	PAEN5	LNAEN5	SWTX	SWRX	State
L	L	L	L	L	L	Low Power State
L	L	L	H	L	H	HB RX
L	H	L	L	L	H	LB RX
L	L	H	L	H	L	HB TX
H	L	L	L	H	L	LB TX

### Package Drawing

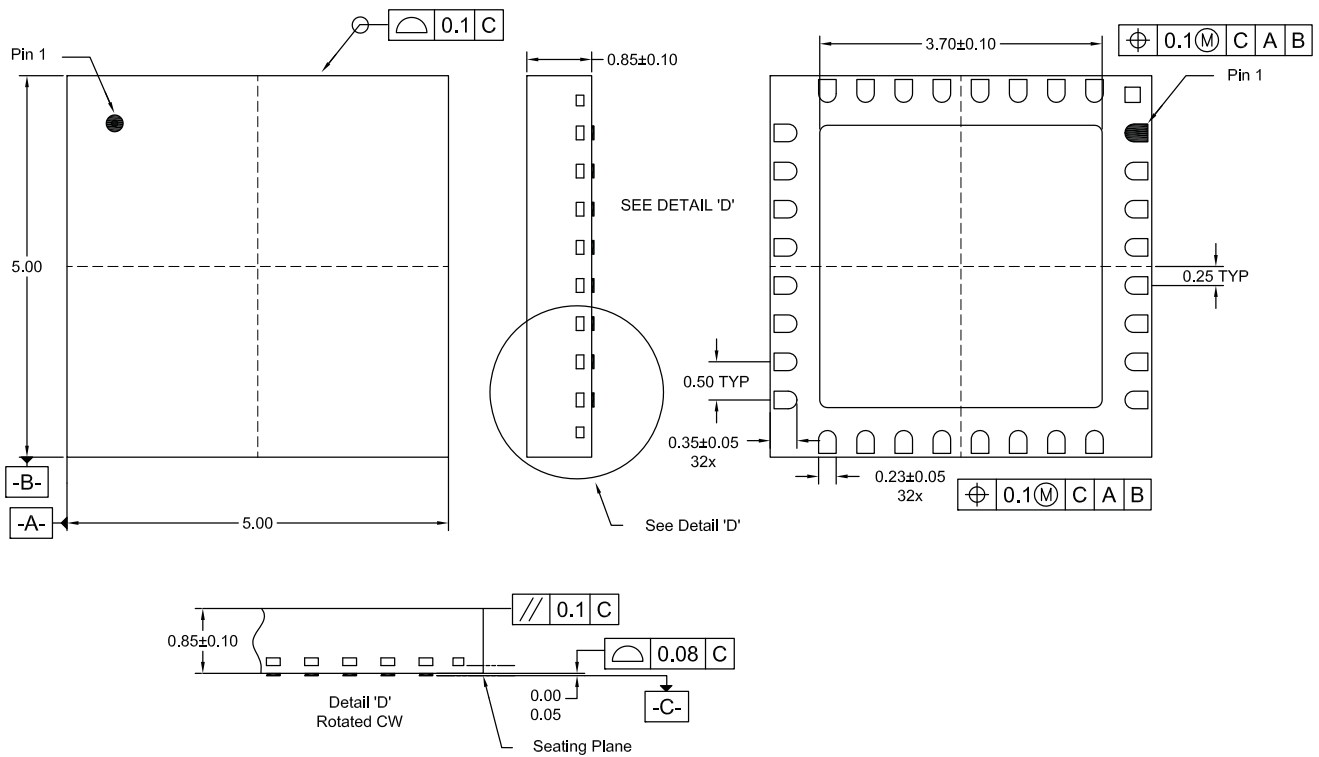



## PCB Design Requirements

### PCB Surface Finish

The PCB surface finish used for RFMD's qualification process is electroless nickel, immersion gold. Typical thickness is 3µinch to 8µinch gold over 180µinch nickel.

### PCB Land Pattern Recommendation

PCB land patterns for RFMD components are based on IPC-7351 standards and RFMD empirical data. The pad pattern shown has been developed and tested for optimized assembly at RFMD. The PCB land pattern has been developed to accommodate lead and package tolerances. Since surface mount processes vary from company to company, careful process development is recommended.

### PCB Metal Land and Solder Mask Pattern

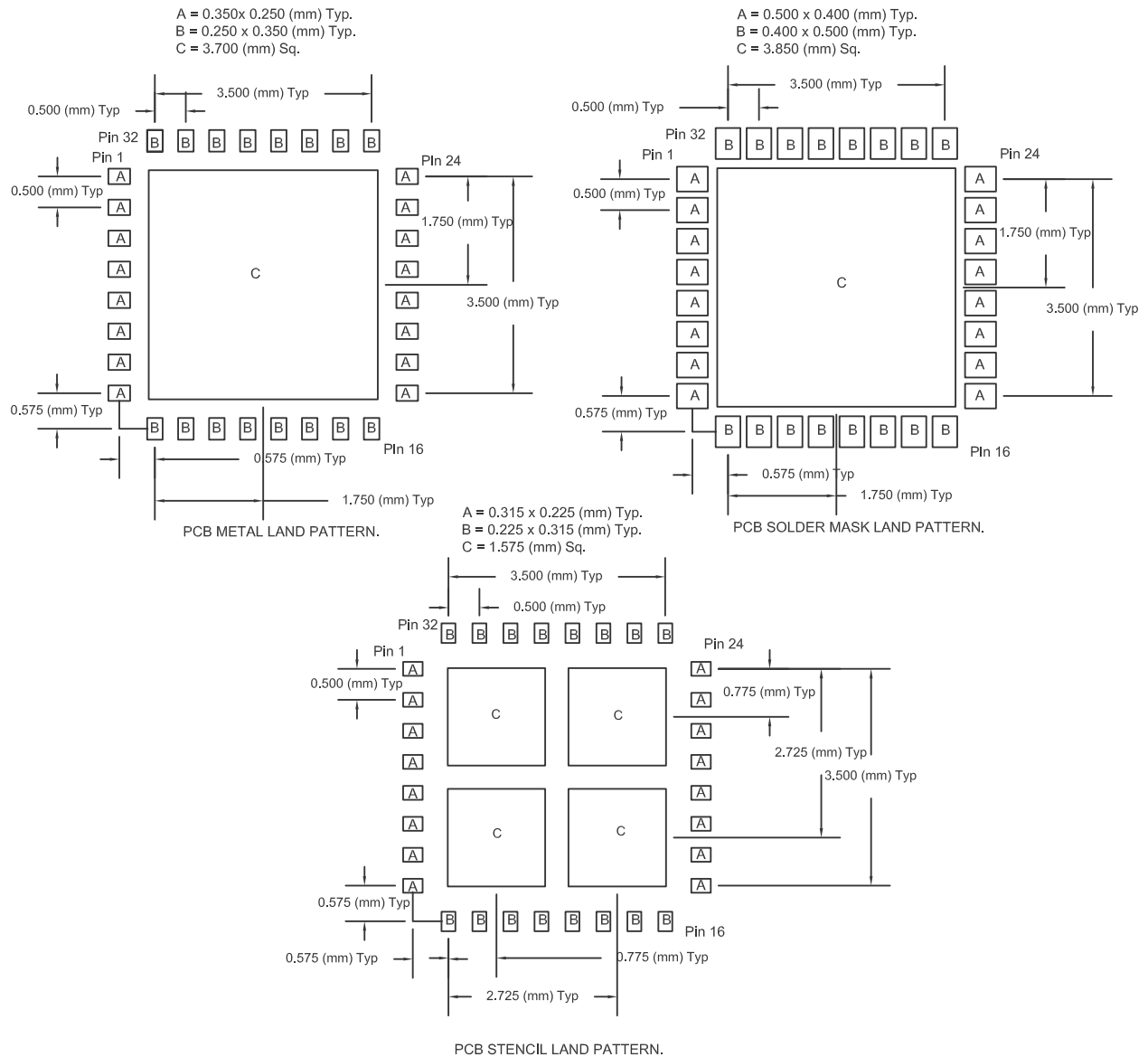

Thermal vias for center slug "C" should be incorporated into the PCB design. The number and size of thermal vias will depend on the application. Example of the number and size of vias can be found on the RFMD evaluation board layout.

### Pin Out (Top View)

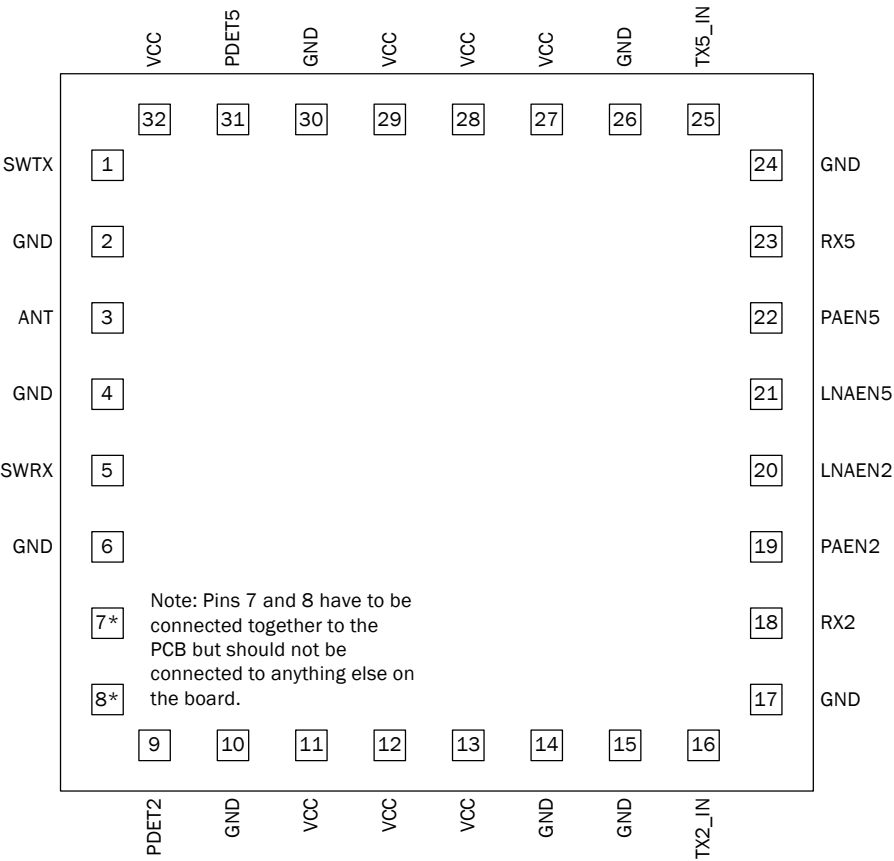

### Evaluation Board Schematic

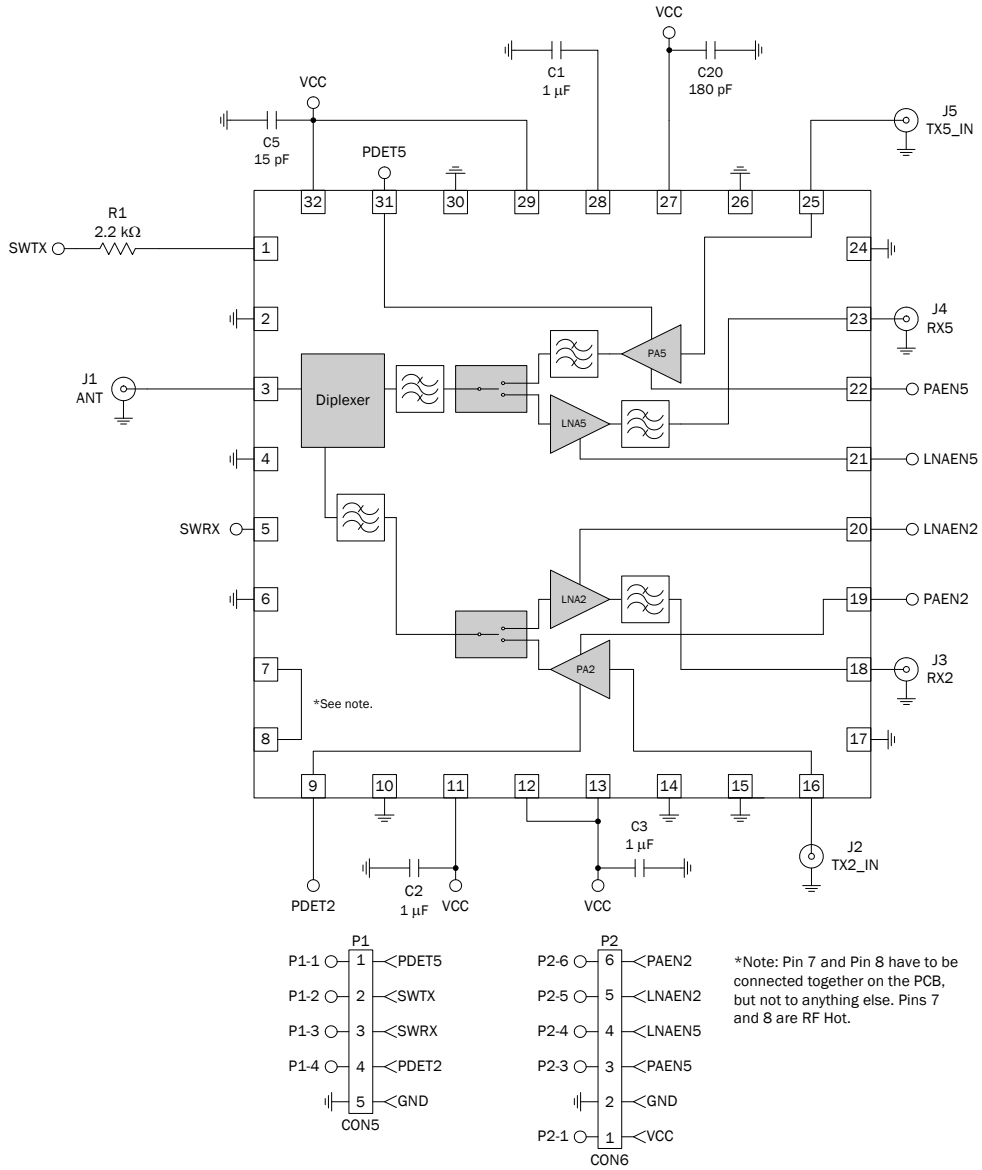

## Evaluation Board Layout

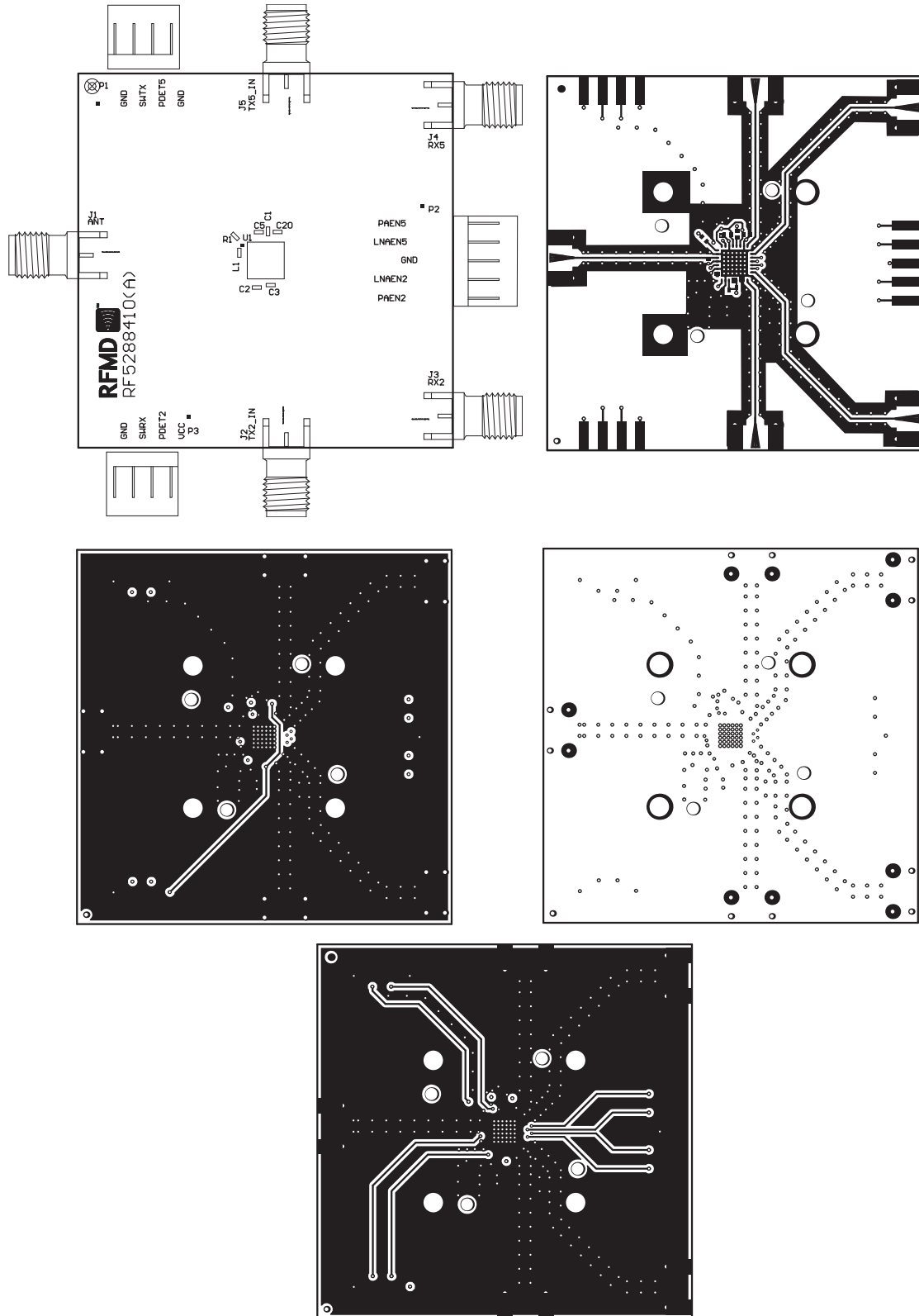

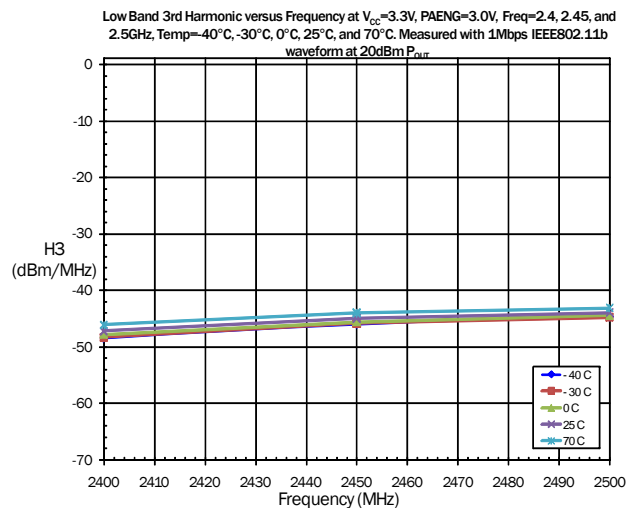
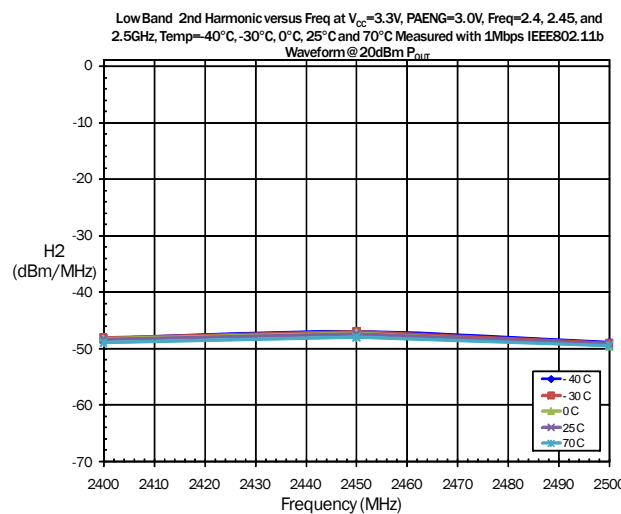
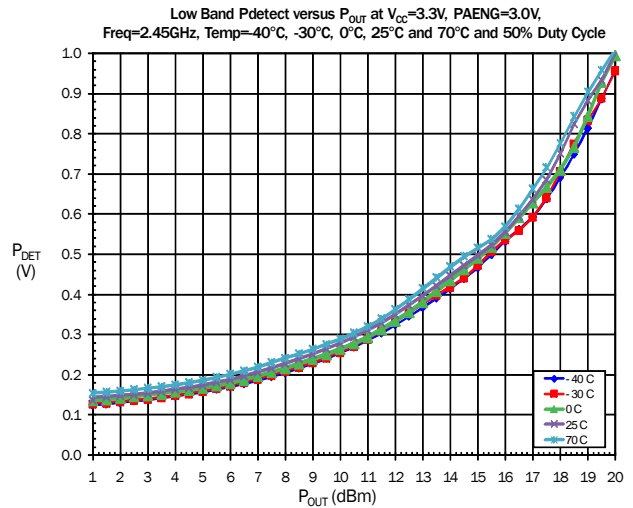
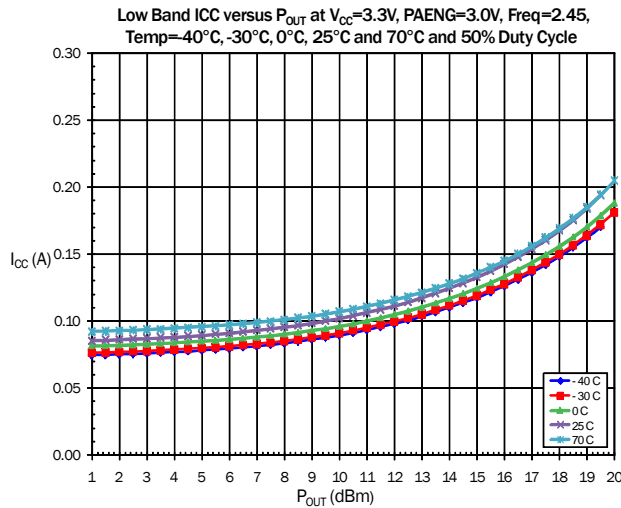
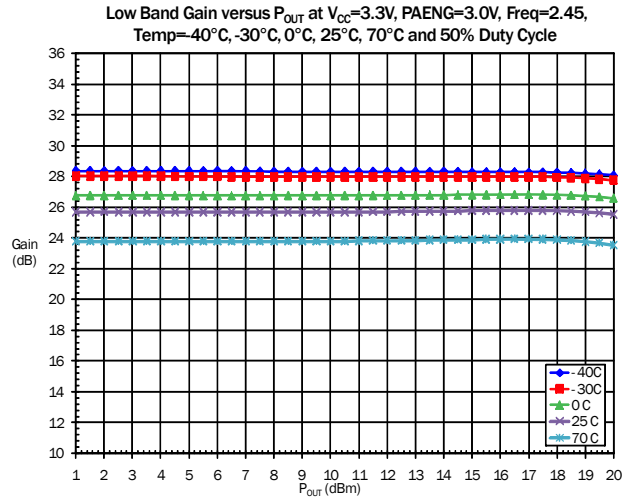
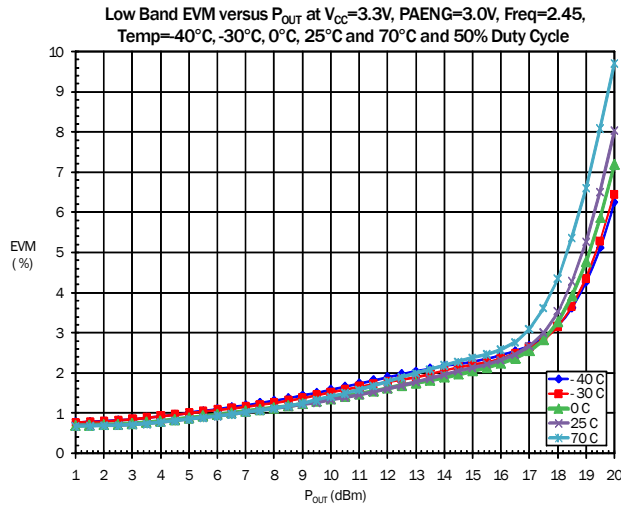

Low Band Typical TX Small Signal Plots at  $V_{CC}=3.3V$ ,  $PAEN2=3.0V$ ,  $SWTX=High$ ,  $SWRX=Low$ ,  $Freq=10MHz$  to  $8500MHz$ ,  $Temp=25^{\circ}C$

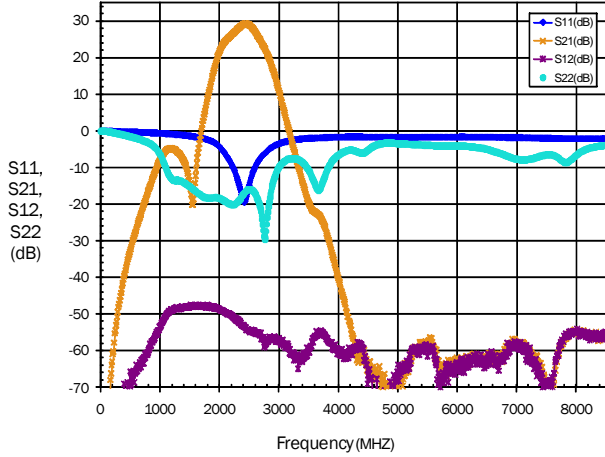

Low Band Typical RX Small Signal Plots at  $V_{CC}=3.3V$ ,  $LNAEN2=3.3V$ ,  $SWTX=Low$ ,  $SWRX=High$ ,  $PAEN2=0V$ ,  $Freq=10MHz$  to  $8500MHz$ ,  $Temp=25^{\circ}C$

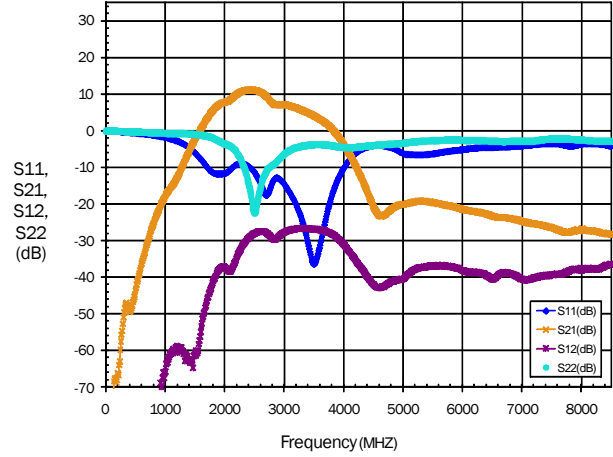

High Band EVM versus  $P_{OUT}$  at  $V_{CC}=3.3V$ ,  $PAENG=3.0V$ ,  $Freq=5.1GHz$ ,  $Temp=-40^{\circ}C$ ,  $-30^{\circ}C$ ,  $0^{\circ}C$ ,  $25^{\circ}C$ , and  $70^{\circ}C$  and 50% Duty Cycle

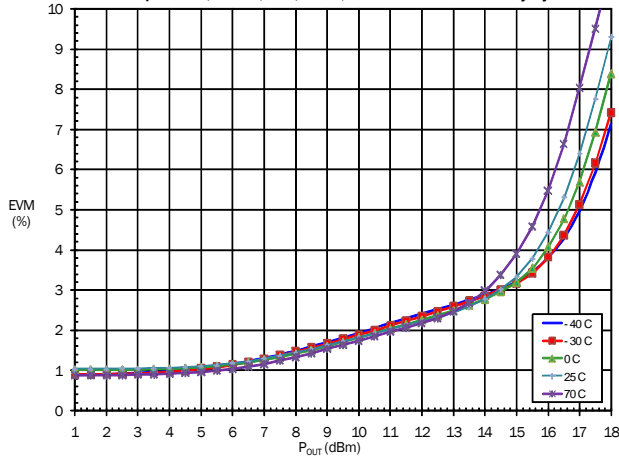

High Band EVM versus  $P_{OUT}$  at  $V_{CC}=3.3V$ ,  $PAENG=3.0V$ ,  $Freq=5.85GHz$ ,  $Temp=-40^{\circ}C$ ,  $-30^{\circ}C$ ,  $0^{\circ}C$ ,  $25^{\circ}C$ , and  $70^{\circ}C$  and 50% Duty Cycle

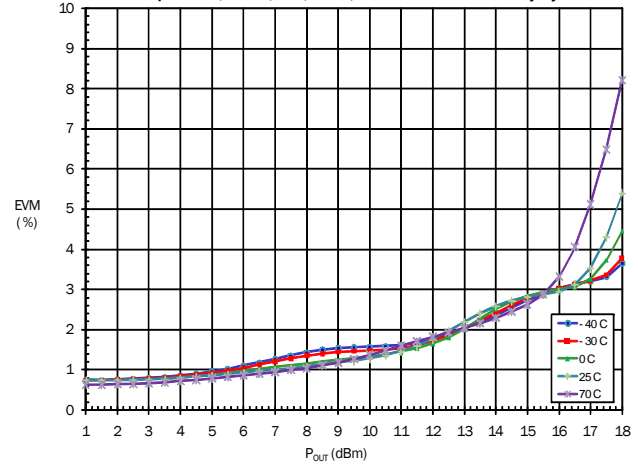

High Band Gain versus  $P_{OUT}$  at  $V_{CC}=3.3V$ ,  $PAENG=3.0V$ ,  $Freq=5.4GHz$ ,  $Temp=-40^{\circ}C$ ,  $-30^{\circ}C$ ,  $0^{\circ}C$ ,  $25^{\circ}C$ , and  $70^{\circ}C$  and 50% Duty Cycle

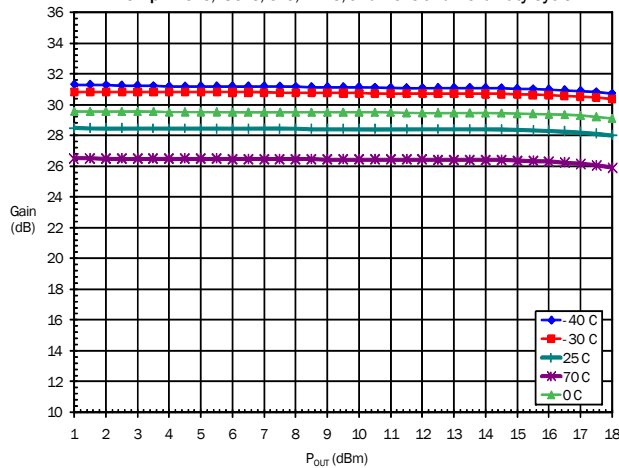

High Band ICC versus  $P_{OUT}$  at  $V_{CC}=3.3V$ ,  $PAENG=3.0V$ ,  $Freq=5.4GHz$ ,  $Temp=-40^{\circ}C$ ,  $-30^{\circ}C$ ,  $0^{\circ}C$ ,  $25^{\circ}C$ , and  $70^{\circ}C$  and 50% Duty Cycle

