

Functional Block Diagram

Features

- +21dBm Typical Output Power From Integrated PA
- Highly Integrated 2.4GHz FSK Transceiver With Selectable Data Rates; 576 kbps, 1.152 Mbps, 1.536 Mbps, 1.755 Mbps, 2.048 Mbps
- Low-IF Receiver Eliminates External IF Filters
- Fractional-N Synthesizer with 30Hz Resolution
- Fully Integrated Digital FIR Tx Data Filter, IF Filters, FM Discriminator, and Rx Data Filter
- Self-calibrating VCO and Filters Eliminate Tuning
- Operating Modes Include DSSS-DCT, DECT, and High Rate (2.048 Mbps) for Wireless Audio and Video
- -97 dBm Sensitivity (0.1% BER) With Integrated LNA
- Includes FastWave™ Embedded Wireless Microcontroller Technology
- Simple 3-Wire Control Interface
- T/R PIN Diode or FET Switch Driver Outputs
- Analog RSSI Output: 35 mV/dB
- Selectable Rx Clock Recovery Output

Applications

- Digital Cordless Telephones DSSS and DECT
- Wireless Streaming Audio and Video
- Wireless Data Links

Product Description

The ML2730 is a single chip fully integrated Frequency Shift Keyed (FSK) transceiver with fully integrated PA. It is developed for a variety of applications operating in the 2.400GHz to 2.485GHz unlicensed ISM band. The ML2730 is mode selectable for operation with digital cordless phones (DSSS or DECT) and higher data rate streaming applications like wireless audio and video.

The ML2730 contains a dual-conversion, low-IF receiver with all channel selectivity on chip. IF filtering, IF gain, and demodulation are performed on-chip, eliminating the need for any external IF filters or production tuning. A post detection filter and a data slicer are integrated to complete the receiver.

The ML2730 transmitter uses an adjustment-free closed loop modulator, which modulates the on-chip VCO filtered data. The ML2730 includes an upconversion mixer, a buffer/predriver, and a power amplifier to produce a typical output power of +21dBm. A fully integrated fractional synthesizer is used in both receive and transmit modes. Power supply regulation is included in the ML2730, providing circuit isolation and consistent performance over supply voltages between 2.8V and 3.6V.

Optimum Technology Matching® Applied

- | | | | |
|--------------------------------------|---|-------------------------------------|-----------------------------------|
| <input type="checkbox"/> GaAs HBT | <input checked="" type="checkbox"/> SiGe BiCMOS | <input type="checkbox"/> GaAs pHEMT | <input type="checkbox"/> GaN HEMT |
| <input type="checkbox"/> GaAs MESFET | <input type="checkbox"/> Si BiCMOS | <input type="checkbox"/> Si CMOS | <input type="checkbox"/> RF MEMS |
| <input type="checkbox"/> InGaP HBT | <input type="checkbox"/> SiGe HBT | <input type="checkbox"/> Si BJT | <input type="checkbox"/> LDMS |

RF MICRO DEVICES®, RFMD®, Optimum Technology Matching®, Enabling Wireless Connectivity™, PowerStar®, POLARIS™ TOTAL RADIO™ and UltimateBlue™ are trademarks of RFMD, LLC. BLUETOOTH is a trademark owned by Bluetooth SIG, Inc., U.S.A. and licensed for use by RFMD. All other trade names, trademarks and registered trademarks are the property of their respective owners. ©2006, RF Micro Devices, Inc.

Absolute Maximum Ratings

Parameter	Rating	Unit
VCC	VSS-0.3 to 3.6	V
VCC_PA	VSS-0.3 to 4.5	V
Junction Temperature	150	°C
Storage Temperature	-65 to +150	°C
Lead Temperature (Soldering, 10s)	260	°C
Ambient Temperature Range (T _A)	-10 to +80	°C
VCC Range [VDD (pin 9), VCCPLL (pin 19), VCCA (pin 27)]	2.8 to 3.6	V
VCC_PA Range [VCC_PA (pin 31)]	3.0 to 4.5	V
Thermal Resistance (θ _{JA})	36	°C/W



Caution! ESD sensitive device.

Exceeding any one or a combination of the Absolute Maximum Rating conditions may cause permanent damage to the device. Extended application of Absolute Maximum Rating conditions to the device may reduce device reliability. Specified typical performance or functional operation of the device under Absolute Maximum Rating conditions is not implied.

RoHS status based on EUDirective2002/95/EC (at time of this document revision).

The information in this publication is believed to be accurate and reliable. However, no responsibility is assumed by RF Micro Devices, Inc. ("RFMD") for its use, nor for any infringement of patents, or other rights of third parties, resulting from its use. No license is granted by implication or otherwise under any patent or patent rights of RFMD. RFMD reserves the right to change component circuitry, recommended application circuitry and specifications at any time without prior notice.

Parameter	Specification			Unit	Condition
	Min.	Typ.	Max.		
Power Supplies					Unless otherwise specified T _A =25 °C and the supply voltage is V _{CC} =3.3V, V _{CC_PA} =3.6V, R _{ISET} =381Ω, F _{REF} =12.288MHz, DATA RATE=1.536Mbps, all measurements are normalized to the IC pins.
Supply current, STANDBY mode (I _{STBY})		2		μA	DC supply connected, XCEN low, RXON high.
Supply current, STANDBY mode with Patch code retention (I _{STBY})		TBD		μA	DC supply connected, XCEN low, RXON high.
Supply current, RECEIVE mode (I _{RX})		63		mA	RX chain active, data being received.
Supply current, TRANSMIT mode (I _{TX})		65		mA	TX chain active, data being transmitted.
Supply current, TRANSMIT mode (I _{PA})		100		mA	TX chain active, data being transmitted, +21dBm output.
Synthesizer					
Lock time for any in band frequency change (RX-TX; TX-RX; all combinations) (t _{FH})		50		μsec	From EN asserted to RX valid data (RX) or valid TX data to within 50kHz of final frequency.
Reference signal frequency (f _{FREF})		12.288		MHz	Data Rate=1.5360, 1.7554, and 2.0480Mbps
		13.824		MHz	Data Rate=576, 1,152Kbps
Reference Signal Input Level (V _{FREF})	0.5			V _{p,p}	Clipped sine, AC coupled

Parameter	Specification			Unit	Condition
	Min.	Typ.	Max.		
Receiver					
Receive input frequency range (F_{RXI})	2.400		2.485	GHz	
Input Impedance Differential (Z_{RX})		100		Ω	Differential
Channel Spacing (F_{STEP})		1.728		MHz	Data Range = 1.1520Mbps
		2.048		MHz	Data Range = 1.5360Mbps
		4.096		MHz	Data Range = 1.7554Mbps
		4.096		MHz	Data Range = 2.0480Mbps
Input Power (DR)			+10	dBm	<0.1%BER at 1.1520Mbps
			+10	dBm	<0.1%BER at 1.5360Mbps
			+10	dBm	<0.1%BER at 1.7554Mbps
			+10	dBm	<0.1%BER at 2.0480Mbps
Input Sensitivity (S_{RXI})		TBD		dBm	<0.1%BER at 1.1520Mbps
		-97		dBm	<0.1% BER at 1.5360Mbps
		TBD		dBm	<0.1% BER at 1.7554Mbps
		TBD		dBm	<0.1% BER at 2.0480Mbps
RX conducted emissions at RXI (P_{RXI})			-50	dBm	RXI terminated in 50 Ω
RX Chain Image rejection ratio (IRR)		35		dB	
RX adjacent channel(s) rejection. Wanted signal = -80dBm (ACR)		15		dB	± 1 channel offset
		40		dB	± 2 channels offset
		45		dB	± 3 or more channels offset
Co-Channel rejection, 0.1% BER (CCR)		-9		dB	Wanted signal = -80dBm, Unwanted signal is GFSK modulated with 1.536Mbps PRBS data, BT=0.9
RSSI					
RSSI rise time, 20% to 80% (t_{R_RSSI})		5	10	μ sec	20pF loading on RSSI pin RF off to -15dBm
RSSI fall time, 80% to 20% (t_{F_RSSI})		5	10	μ sec	20pF loading on RSSI pin -15dBm to RF off
RSSI maximum voltage (V_{RSMX})		2.5		V	-10dBm into RXI
RSSI midrange voltage (V_{RSMO})		2.3		V	-40dBm into RXI
RSSI minimum voltage (V_{RSMN})		0.2		V	No signal applied
RSSI sensitivity (V_{RSMXC})		35		mV/dB	($V_{-40dBm} - V_{-50dBm}$)/10dB
RSSI accuracy (G_{RSSI})		± 3		dB	Deviation from best fit straight line

Parameter	Specification			Unit	Condition
	Min.	Typ.	Max.		
Transmitter					
Transmit input frequency range (F _{TXO})	2.400		2.485	GHz	
Transmit Modulation Deviation (F _{DEV})		±400		kHz	Data Range= 1.1520Mbps
		±512		kHz	Data Range= 1.5360Mbps
		±596		kHz	Data Range= 1.7554Mbps
		±680		kHz	Data Range= 2.0480Mbps
Transmit Filter Bandwidth/Symbol Rate Ratio (BT)		0.5			Data Range= 1.1520Mbps
		0.9			Data Range= 1.5360Mbps
		0.8			Data Range= 1.7554Mbps
		0.7			Data Range= 2.0480Mbps
TX LO feed through (P _{LO})		-35		dBc	P _{TXO} = +21dBm, FSPUR=1/3, 2/3, 4/3, and 5/3 F _{TXO}
Interface Logic Levels					
CMOS Digital Input Pins (XCEN, RXON, DIN, DATASEL)					
Input High Voltage (V _{IH})	V _{DD} *0.7		V _{DD}	V	
Input Low Voltage (V _{IL})	0		V _{DD} *0.3	V	
Input Bias Current (I _B)	-5		+5	µA	All states
Input Capacitance (C _{IN})		4		pF	1MHz test frequency
CMOS Digital Output Pins (SW_CTRL, RXCLK, DOUT)					
SW_CTRL output high voltage (V _{OH})	VDD-0.4			V	Sourcing 5.0mA
SW_CTRL output low voltage (V _{OL})			0.4	V	Sinking 5.0mA
SW_CTRL source/sink current (I _O)	±5.0	±8.0		mA	
RXCLK (recovered clock) output high voltage (V _{OH})	VDD-0.4			V	Sourcing 0.1mA
RXCLK (recovered clock) output low voltage (V _{OL})			0.4	V	Sinking 0.1mA
DOUT (data output) output high voltage (V _{OH})	VDD-0.4			V	Sourcing 0.1mA
DOUT (data output) output low voltage (V _{OL})			0.4	V	Sinking 0.1mA
Analog Output Pins (AOUT)					
Quiescent output voltage at AOUT (V _{ODC})		1.15		V	
Output voltage swing at AOUT (V _{OPK})		0.8		V _{P-P}	

Parameter	Specification			Unit	Condition
	Min.	Typ.	Max.		
3 Wire Serial Bus Timing					
CLK Input Rise Time (Note 1) (t_r)			15	ns	
CLK Input Fall Time (Note 1) (t_f)			15	ns	
CLK Period (t_{ck})	50			ns	
EN Pulse Width (t_{ew})	200			ns	
Delay from last Clock Rising Edge to Rise of EN (t_j)	15			ns	
EN Setup Time to Ignore next Rising CLK (t_{se})	15			ns	
Data-to-CLK Setup Time (t_s)	15			ns	
Data-to-CLK Hold Time (t_h)	15			ns	

Note 1: Serial I/O clock maximum rise and fall times are based on the minimum clock period. Longer rise and fall times can be accommodated for slower clocks provided the rise and fall times remain less than 20% of the clock period and all set up and hold time minimums are met with respect to the CMOS switching points (V_{IL} MAX and V_{IH} MIN). The serial I/O clock rise and fall times are limited to an absolute maximum of 100ns.

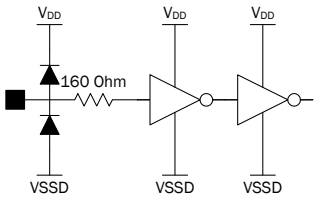
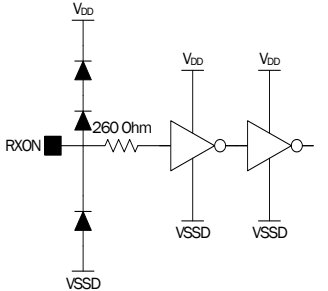
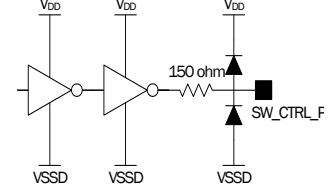
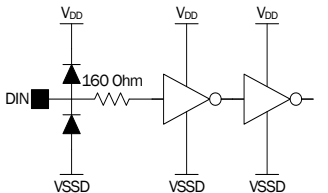
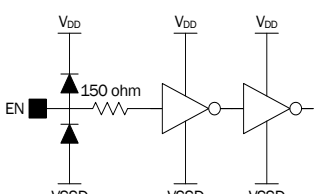
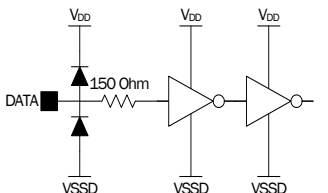
Pin	Function	Description	Interface Schematic
1	XCEN	Transceiver Enable input. Enables the bandgap reference and voltage regulators when high, enabling normal control functions. Consumes only leakage current in STANDBY mode when low. Operating mode= V_{IH} Standby mode= V_{IL}	
2	RXON	TX/RX Control Input. Switches the transceiver between TRANSMIT and RECIEVE mode. Receive mode= V_{IH} Transmit mode= V_{IL}	
3	SW_CTRL_P	TR switch control output, positive polarity. Logic high (V_{OH}) while transmitting Logic low (V_{OL}) while receiving	
4	DIN	Transmit Data Input.	
5	VSSD	Digital ground for all digital I/O circuits and control logic.	
6	EN	Control Bus Enable. Enable pin for the three-wire serial control bus. The control registers are loaded on the rising edge of this signal. Serial control bus data is ignored when this signal is high (V_{IH}).	
7	DATA	Serial Control Bus Data.	

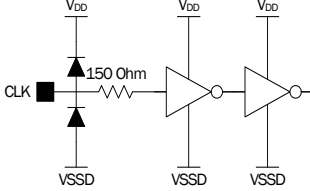
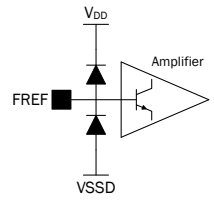
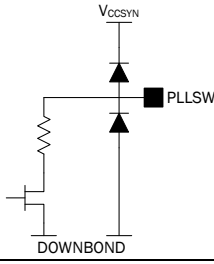
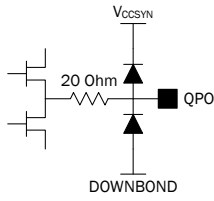
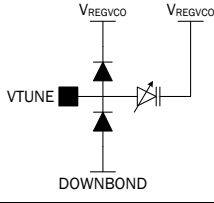
Pin	Function	Description	Interface Schematic
8	CLK	Serial control bus data is clocked in on the rising edge and only when EN is low.	
9	VDD	3.3V _{DC} power supply input.	
10	VREG_1P8	1.8V _{DC} regulator output. Place capacitor between this pin and ground to decouple (bypass) noise and to stabilize the regulator.	
11	VBG_1P8	1.13V _{DC} bandgap voltage output. Place capacitor between this pin and ground to decouple (bypass) noise.	
12	FREF	Input reference frequency.	
13	VCCSYN	2.7V _{DC} power supply input. Must be connected to VREGPLL pin externally.	
14	PLL_SW	Loop filter control switch.	
15	QPO	Charge pump output of the phase detector. This is connected to the external PLL loop filter.	
16	VTUNE	VCO Tuning Voltage input from the PLL loop filter. This pin is very sensitive to noise coupling and leakage currents.	
17	VREGVCO	2.5V _{DC} regulator output. Place capacitor between this pin and ground to decouple (bypass) noise and to stabilize the regulator.	
18	VREGPLL	2.7V _{DC} power supply output. Place capacitor between this pin and ground to decouple (bypass) noise and to stabilize the regulator.	
19	VCCPLL	3.3V _{DC} power supply input. Place capacitor between this pin and ground to decouple (bypass) noise.	
20	VBG_VCO	1.13V _{DC} bandgap voltage output. Place capacitor between this pin and ground to decouple (bypass) noise.	

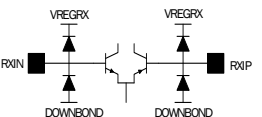
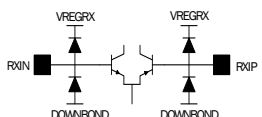
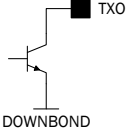
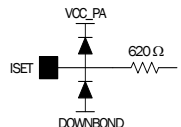
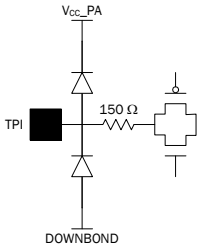
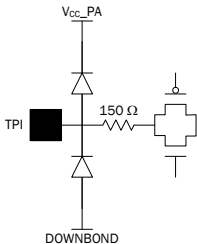
Pin	Function	Description	Interface Schematic
21	VREGLNA	2.7V _{DC} regular output. Place capacitor between this pin and ground to decouple (bypass) noise and to stabilize the regulator.	
22	RXIN	Differential receive RF Input.	
23	RXIP	Differential receive RF Input.	
24	VREGRX	2.7V _{DC} regular output. Place capacitor between this pin and ground to decouple (bypass) noise and to stabilize the regulator.	
25	VBG_RF	Bandgap 1.24V decouple voltage. Decoupled to ground with a capacitor.	
26	VREGTX	2.7V _{DC} power supply input. Must be connected to VREGRX pin externally.	
27	VCCA	3.3V _{DC} power supply input.	
28	TXO	TX RF open-collector output. Connect this pin to VCC using an (RF blocking) inductor.	
29	ISET	TX I _{SET} resistor.	
30	VBG_PA	1.13V _{DC} bandgap voltage output. Place capacitor between this pin and ground to decouple (bypass) noise.	
31	VCC_PA	Unregulated Battery DC Power Supply Input.	
32	VREGPA	Programmable 3.67V _{DC} */3.44V _{DC} /3.3V _{DC} regulator output. Place capacitor between this pin and ground to decouple (bypass) noise and to stabilize the regulator. *Not recommended for use - Exceeds Absolute Maximum Ratings.	
33	VREGIF	2.7V _{DC} regular output. Place capacitor between this pin and ground to decouple (bypass) noise and to stabilize the regulator.	
34	TPI	RX/TX test port. Used to test or apply test signals to both RX and TX sections.	
35	TPQ	RX/TX test port. Used to test or apply test signals to both RX and TX sections.	

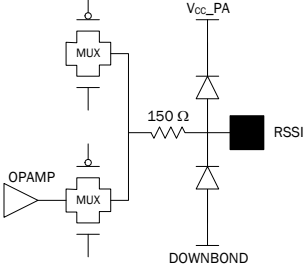
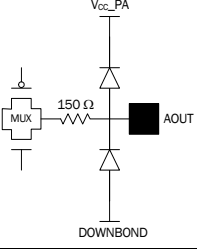
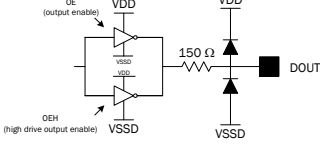
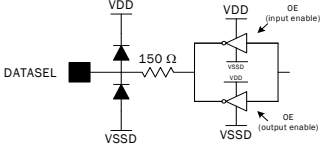
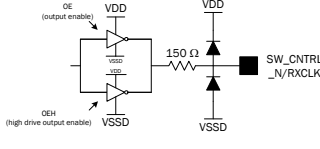
Pin	Function	Description	Interface Schematic
36	RSSI	Receive Signal Strength Indicator. Also used as RX/TX test port.	
37	AOUT	Analog data output.	
38	DOUT	Serial digital output after demodulation, bit rate filtering and center data slicing. CMOS levels with controlled slew rates.	
39	DATASEL or PLL_Lock	When TCMOD=4 or 5, this pin becomes an input and it controls the time constant of the data slicer. DATASEL=V _{IH} selects 6 uS time constant DATASEL=V _{IL} selects 300 uS time constant -else- PLL_Lock=V _{DH} indicates PLL is locked PLL_Lock=V _{DL} indicated PLL is not locked	
40	SW_CNTRL _N or RXCLK	TR switch control output, negative polarity. V _{OL} while transmitting V _{OH} while receiving -or- Recovered RXCLK clock output is multiplexed in this pin. When configured for RXCLK output, clock pulses may be observed for 6 uS to 8 uS after the falling edge of RXON before setting to logic high (V _{IH}).	

Pin Configuration (Top View)

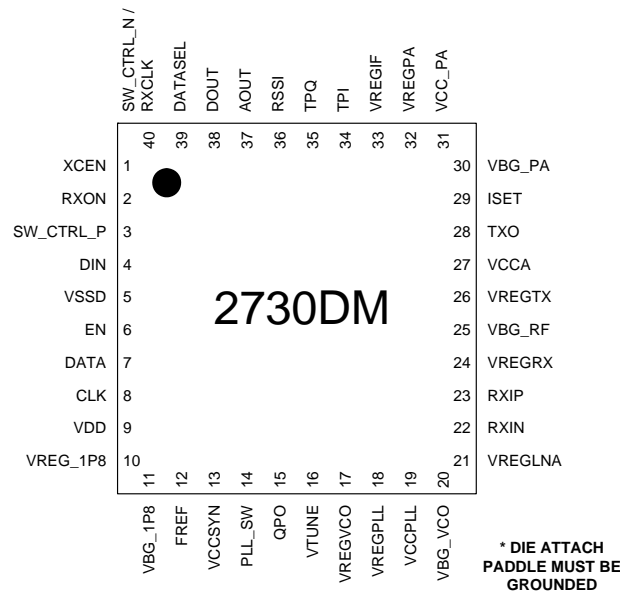

Functional Description

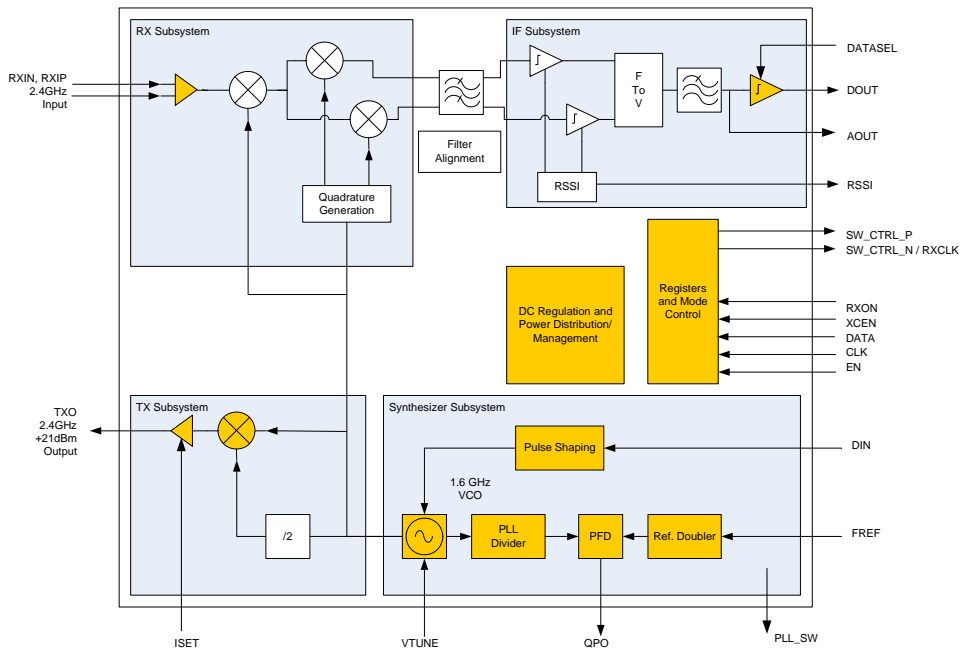

Figure 1: ML2730 Block Diagram

The ML2730 is a single chip wireless digital transceiver. The ML2730 integrates all the frequency generation, receiver and transmit functions requiring only a TR switch to form a complete 2.400GHz to 2.485GHz ISM radio band. The ML2730 is designed to transmit and receive 576kbps to 2.048Mbps signals using channels spaced from 1.728MHz to 4.096MHz over the 2.400GHz to 2.485GHz ISM band.

Receiver

The ML2730 contains a dual conversion, low_IF receiver with all channel selectivity on-chip. The signal enters through a differential LNA to the 1st mixer which down-converts the 2.4GHz input to a high 1st IF of 0.8GHz, followed by an image reject 2nd mixer that brings this IF signal down to a low IF frequency. On chip IF filtering, gain, and demodulation are performed at a 864kHz IF frequency for the 576kbps and 1.152Mbps data rate, a 1.024MHz IF frequency for the 1.536Mbps data rate, or a 2.048MHz IF frequency for the 1.755Mbps and 2.048Mbps data rates.

No external filters or production tuning are required. A post detection filter and data slicer are also provided to complete the receiver. The DATASEL pin allows selection between two different time constants in the data slicer. Rx clock recovery is optionally performed for the 1.152Mbps, 1.536Mbps, 1.755Mbps, 2.048Mbps data rate to aid those applications using a simple microcontroller based MODEM. A receive signal strength indication (RSSI) signal is also provided. RSSI (an indication of field strength) can be used by the system to determine transmit power control (conserve battery life) and/or determine if a given channel is occupied.

Automatic VCO and Filter Alignment

The VCO and IF filters are calibrated to remove process and temperature variation. IF filter and VCO calibration occurs when the chip is first powered on and at specified intervals during normal operation. The calibration is transparent to the normal operation of the ML2730 and is absorbed in the system timing shown in Figure 2 and Table 2. The self-calibration adjusts:

- VCO center frequency
- Discriminator center frequency
- IF filter center frequency and bandwidth
- Receiver data low-pass filter bandwidth

Transmitter and PA

The ML2730 transmitter consists of an up-conversion mixer followed by a programmable gain amplifier, to allow factory calibration of the output power, and a power amplifier (PA). The input data is filtered before being sent to an adjustment free VCO modulator. An FIR Gaussian pulse shaping filter is used followed by DAC and interpolation filter for clock rejection. The output of the modulator is up-converted by a mixer and amplified with a PA to deliver 21dBm output power. A complementary T/R switch control output with adjustable timing is provided to control the external T/R switch.

PLL/Synthesizer

A single, on-chip 1.6GHz fractional-N synthesizer is used to generate the receiver LO and transmit carrier. The VCO has an on-chip resonator, active devices and tuning circuitry for a completely integrated VCO function. All required DC voltage regulation is within the IC. The PLL center frequency is programmed with a 23 bit word written via the SPI port during either standby or active operation.

A lock detect circuit monitors the state of the PLL loop allowing the PA to be disabled prior to the PLL achieving lock in TRANSMIT mode. In RECEIVE mode, the synthesizer produces a low side LO frequency offset (compared to TX mode) to produce the required IF frequency.

Modes of Operation

The ML2730 has three key modes of operation:

- STANDBY: All circuits powered down except the control interface (static CMOS)
- RECEIVE: Receiver circuits active
- TRANSMIT: Transmitter circuits active

Mode Control

The two operational modes controlled by RXON are RECEIVE and TRANSMIT. XCEN is the chip enable/disable control pin which sets the device to either operational or STANDBY modes. The relationship between the parallel control lines and the mode of operation of the IC is summarized in Table 1.

Table 1: Modes of Operation

XCEN	RXON	MODE NAME	FUNCTION
0	X	STANDBY	Control interfaces active, all other circuits powered down
1	1	RECEIVE	Receiver time slot
1	0	TRANSMIT	Transmit time slot

STANDBY Mode

In STANDBY mode, the ML2730 transceiver is powered down. The only active circuits are the control interfaces, which are static CMOS to minimize power consumption. The serial control interface and control registers remain powered up and will accept and retain programming data as long as the VDD and VCCA are present.

RECEIVE Mode

In RECEIVE mode, the received signal at 2.4GHz is down converted, band pass filtered (IF filtered), fed to the frequency-to-voltage converter, and then low-pass filtered. The output of the low-pass filter is available at both the AOUT pin and to the on-chip data slicer that produces NRZ digital data presented at the DOUT pin. An RSSI output voltage is also provided.

TRANSMIT Mode

In TRANSMIT mode, the PLL loop is closed to eliminate frequency drift. A closed loop FSK modulator modulates both the VCO and the fractional-N PLL. The VCO is directly modulated with filtered FSK transmit data. The PLL is driven by a sigma-delta modulator, which ensures that the PLL follows the mean frequency of the modulated VCO.

Control Interface

There are two types of input/output (I/O) signals to control and monitor the ML2730:

- Discrete I/O: XCEN, RXON, SW_CTRL_P, SW_CTRL_N, DATASEL
- Serial Control Bus: EN, DATA, CLK

The ML2730 transceiver is used in time division duplex (TDD) mode, where the transceivers at each end of a radio link alternately transmit and receive. Prior to entering receive mode, the ML2730 goes through a “self-calibration” sequence, where the VCO, IF, and data filters are frequency aligned. This occurs in the time period just before the PLL settles to the LO frequency. These calibration cycles are triggered by logic transitions on the control interface. Figure 2a and 2b show the normal operating cycle for the ML2730. Figure 2a shows the timing when register variable PAFIRST is set to 0, causing the switch control signals to change state before the PA is enabled. Figure 2b shows the timing when register variable PAFIRST is set to 1, causing the switch control signals to change state after the PA is enabled.

RF Control: XCEN, RXON, SW_CTRL

The XCEN pin enables/disables the ML2730 and places the device in either STANDBY or ACTIVE modes.

The RXON pin determines which active mode the ML2730 is in: RECEIVE or TRANSMIT.

SW_CTRL_P and SW_CTRL_N are complimentary CMOS outputs with 5mA drive capability that controls an off-chip T/R switch. They can directly drive PIN diodes. SW_CTRL_P outputs a logic high when RXON is asserted low and a logic low at all other times. The time delays between RXON and SW_CTRL_P are programmable and are shown in Figure 2 and Table 3. These outputs are inhibited when the PLL is not locked.

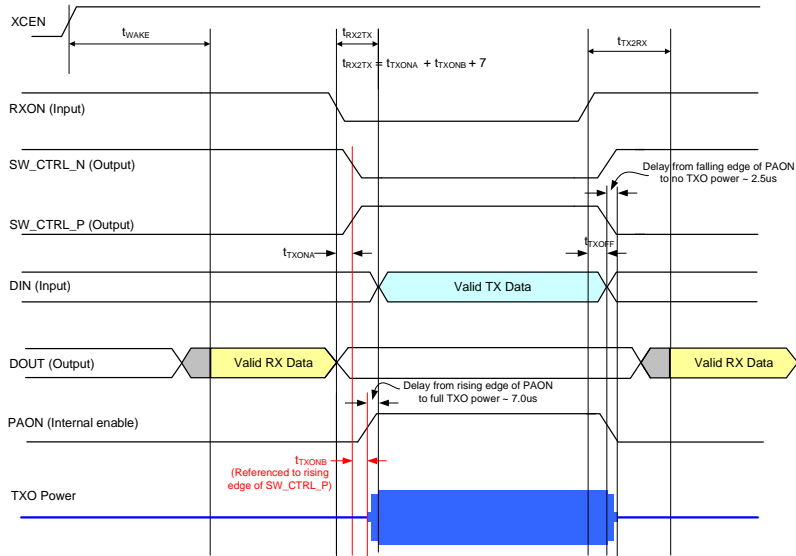

Figure 2a: Control Timing for TDD Operation, PAFIRST=0

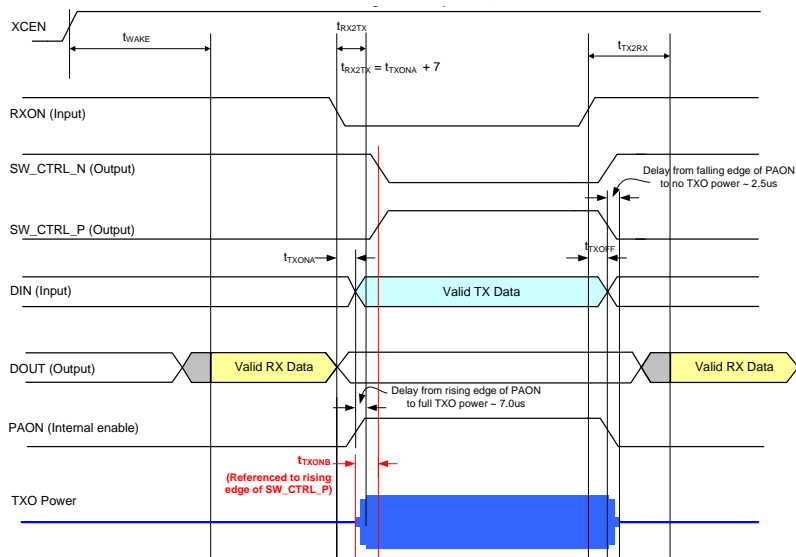

Figure 2b: Control Timing for TDD Operation, PAFIRST=1

Table 2 shows the minimum time required between control interface transitions.

Table 2: Transceiver Control Interface Timing (using default register values).

SYMBOL	PARAMETER	Worst Case Timing	UNITS
t_{WAKE}	Time from XCEN asserted to valid RECEIVE data out	325	μsec
t_{FH}	Time from rising edge of Serial Bus EN to valid RECEIVE data out (channel scan mode, one channel hop, PLL re-locking triggered by rising EN). NOIVCOC=0	115	μsec
t_{FH}	Time from rising edge of Serial Bus EN to valid RECEIVE data out (channel scan mode, one channel hop, PLL re-locking triggered by rising EN). NOIVCOC=1	70	μsec
t_{TX2RX}	Time from rising edge of RXON to valid RECEIVE data out. NOIVCOC=0, with calibration	120	μsec
	no calibration	90	
t_{TX2RX}	Time from rising edge of RXON to valid RECEIVE data out. NOIVCOC=1, with calibration	65	μsec
	no calibration	40	
t_{RX2TX}	Time from falling edge on RXON to start of valid data on DIN pin. Some RF energy will be present on TXO during this period but PAON will be unasserted. TTXONA=0	60	μsec
t_{RX2TX}	Time from falling edge on RXON to start of valid data on DIN pin. Some RF energy will be present on TXO during this period but PAON will be unasserted. TTXONA=63	100	μsec
t_{TXONA}	For the case where PAFIRST=0: t_{TXONA} defines the time between falling edge of RXON and rising edge of SW_CTRL_P. $t_{TXONA} = 44 + TTXONA * 8 / \text{fref}$ where TTXONA is an integer from 0 to 63, TTXONB=0.	44 - 85	μsec
	For the case where PAFIRST=1: t_{TXONA} defines the time between falling edge of RXON and rising edge of RF output power. $t_{TXONA} = 47 + TTXONA * 8 / \text{fref}$ where TTXONA is an integer from 0 to 63, TTXONB=0.v	47 - 88	
t_{TXONB}	For the case where PAFIRST=0: t_{TXONB} defines the time between rising edge of SW-CTRL_P and rising edge of RF output power. $t_{TXONB} = 6 + TTXONAB8 / \text{fref}$ where TTXONB is an integer from 0 to 31..	6 - 26	μsec
	For the case where PAFIRST=1: t_{TXONB} defines the time between rising edge of SW-CTRL_P and rising edge of RF output power. $t_{TXONB} = TTXONAB8 / \text{fref}$ where TTXONB is an integer from 0 to 31..	0 - 20	
t_{TXOFF}	Time between falling edge of RF output power and falling edge of RXON signal. $t_{TXOFF} = 3.5 + TTXOFF * 40 / \text{fref}$ where TTXOFF is an interger with range from 0 to 3	3.5 - 13.5	μsec

Channel Scan Timing in Receive Mode

To implement channel scanning the ML2730 is kept in RECEIVE mode (XCEN and RXON high) and the PLL is reprogrammed to select a different RF channel. A VCO and filter calibration cycle is initiated periodically after the serial bus writes to the register controlling the PLL. Any serial bus writes to the other registers (while XCEN= $V_{IL}(0)$) will trigger a complete calibration cycle. Non-PLL register writes (R0 to R4) are only performed when XCEN= $V_{IL}(0)$. Otherwise unstable operation will occur.

Signal diagram for channel scanning is shown in Figure 3.

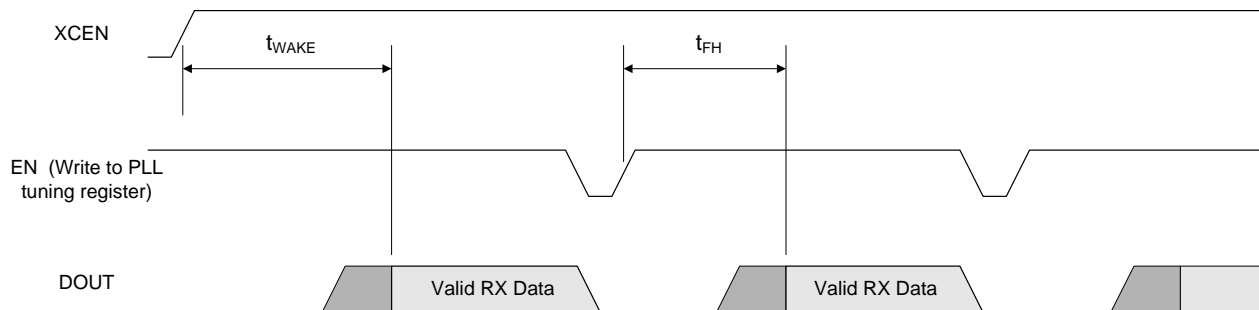

Figure 3: Control Timing when Channel Scanning

Transmit and Receive Data Interfaces

There are two sets of transmit and receive data interfaces for the ML2730:

- Baseband Data: DIN, DOUT, AOUT, RXCLK, FREF, RSSI
- RF Data: RXIN, RXIP, TXO

Please refer to application schematic shown in Figure 4 for recommended component values.

Baseband Data: DIN, DOUT, AOUT, RXCLK

The DIN pin is a CMOS logic level serial data input for 2-FSK modulation on the radio channel. This DIN pin drives data bits into the transmit modulator. There is no re-timing of the chips, so the transmitted 2-FSK chips take their timing from this DIN pin.

The DOUT pin is a corresponding CMOS level digital data output. In DS-FSK mode the ML2730 is designed to operate as a Direct Sequence Spread Spectrum FSK transceiver in the 2.400GHz to 2.485GHz ISM band. The chip rate, bit rate, and spreading code are determined in the baseband processor and the FM deviation and transmit filtering are determined in the ML2730 transceiver.

Setting the AOUT bit in the serial register turns the AOUT pin into a buffered, single-ended output from the data filter. This can be used to drive an off-chip data slicer or an ADC input for a DSP data slicer.

When using the digital output DOUT, FM demodulation, data filtering and center slicing take place in the ML2730 receiver. A clock recovery circuit at the data slicer output extracts the receiver clock RXCLK for those application that do not have access to clock recovery circuitry.

The FREF pin is the master reference frequency (f_{ref}) input for the transceiver. It supplies the frequency for the RF channel frequency and the on-chip filter tuning. The FREF pin is a clipped sine input with on-chip biasing resistors. It can be driven by an AC-coupled sine-wave or a CMOS* logic source. FREF is used as a calibration frequency and as a timing reference in the control circuits. The reference source must be accurate to 20PPM.

The RSSI (Received Signal Strength Indicator) pin supplies a voltage that indicates the amplitude of the received RF signal. The RSSI voltage is proportional to the logarithm of the received power level. It can be connected to the input of an ADC on the baseband IC and is used during channel scanning to detect clear channels on which the radio can transmit.

*For $V(f_{ref}) > 1.5V_{p-p}$, the level of the reference spurious response ($f_{TX} \pm f_{ref}$) increases in proportion to $V(f_{ref})$. $V(f_{ref})$ levels that exceed $2.0V_{p-p}$ will cause the typical reference spur to be greater than -70dBc.

RF Data: RXIN, RXIP, TXO

The RXIN and RXIP receive inputs and the TXO transmit output are the only RF I/O pins. The RXIN and RXIP pins require a single-ended to differential conversion from a 50Ω input impedance and a matching network for best input noise figure and the TXO pin also requires a matching network for maximum power output into 50Ω (see Figure 4).

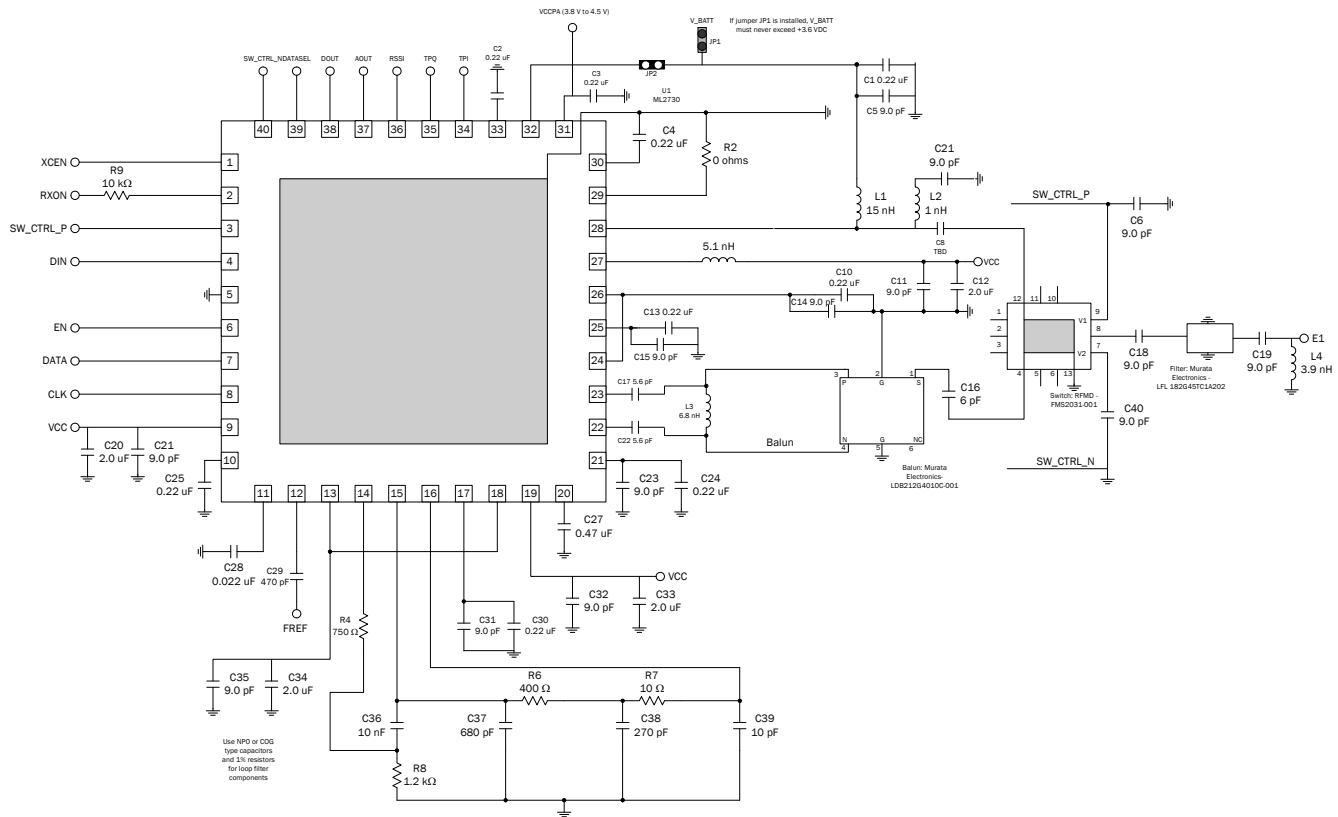

Figure 4: ML2730 Application Schematic

Serial Bus Control: EN, DATA, CLK

A 3-wire serial interface is used for programming the ML2730 configuration registers, which control device mode of operation, pin functions, PLL and reference dividers, internal test modes, and filter alignment. Data words are entered beginning with MSB. The 24 bit configuration register word consists of 5 bit address and 16 bit data fields. When the address field has been decoded the destination register is loaded on the rising edge of EN. Note: Providing less than 24 bits of data will result in unpredictable behavior when EN goes high.

Data and clock signals are ignored when EN is high. When EN is low, data on the DATA pin is clocked into a shift registered by rising edges on the CLK pin. The information is loaded into the addressed latch when EN returns high. This serial interface bus is an industry standard bus commonly found on PLL devices. It can be efficiently programmed by either byte or 24-bit word oriented serial bus hardware. The data latches are implemented in CMOS and use minimal power when the bus is inactive (see Figure 5 and Table 3).

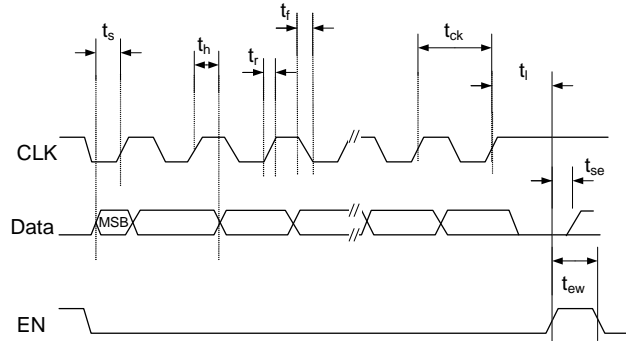

Figure 5: Serial Bus Timing Diagram

Table 3: Serial Bus Timing Diagram

Symbol	Parameter	Min	Max	Units
Bus Clock (CLK)				
t_r	Clock input rise time (Note 1)		15	ns
t_f	Clock input fall time (Note 1)		15	ns
t_{ck}	Clock period	50		ns
Enable (EN)				
t_{ew}	Minimum pulse width	200		ns
t_i	Delay from last clock rising edge to rise of EN	15		ns
t_{se}	Enable set up time to ignore next rising clock	15		ns
Bus Data (DATA)				
t_s	Data to clock set up time	15		ns
t_h	Data to clock hold time	15		ns

Note 1: Serial I/O clock maximum rise and fall times are based on the minimum clock period. Longer rise and fall times can be accommodated for slower clocks provided the rise and fall times remain less than 20% of the clock period and all set up and hold time minimums are met with respect to the CMOS switching points (V_{IL} MAX and V_{IH} MIN). The serial I/O clock rise and fall times are limited to an absolute maximum of 100ns.

Serial Frequency Word and Configuration Registers

Table 4: Serial Word Format (Frequency or Configuration)

Bit				
23	22	21	20:16	15:0
0	PLL Frequency Word			
1	RESET	Wen (Must be set to 1 to write register)	ADDRESS	CDATA (see Table 5)

Table 5: Configuration Register Map showing ROM Default Values

Register (default)	Bit															
	15	14	13	12	11	10	9	8	7	6	5	4	3	2	1	0
R0 (0x010E)	UWD-POL	TCMOD			PLL-LACT	Rate			Reserved							
	0	0	0	0	0	0	0	1	0	0	0	0	1	1	1	0
R1 (0x8880)	CDRDLY				RXIADJMIX1		RESERVED				TXFILT-EDGE	TXFILT-POL	RSSIDL	UW1ER	RESERVED	
	1	0	0	0	1	0	0	0	1	0	0	0	0	0	0	0
R2 (0x4080)	Reserved	RAOUT-EN	TTXONB						CDREN	PA2CTL	TTXONA					
	0	1	0	0	0	0	0	0	1	0	0	0	0	0	0	0
R3 (0x8886)	Reserved								DIVBASEOFFS				PA-FIRST	TTXOFF		NOIV-COC
	1	0	0	0	1	0	0	0	1	0	0	0	0	1	1	0
R4 (0xC008)	MDCALV								Reserved							
	0	0	0	0	0	0	0	0	0	0	0	0	0	0	0	0

Serial Word Definitions

There are two types of serial words used, specified by the state of Bit 23. Bit 23=0 sets the serial word type to “frequency” and Bit 23=1 specifies the serial transaction type as a “configuration word”.

Bit	Definition
23	Specifies whether this serial transaction is type PLL frequency or type configuration register.
22:0	Data

Value	Definition
0	PLL frequency specification word.
1	Configuration register specification word.

PLL Frequency Word

The PLL Frequency Word may be sent during standby (XCEN=0) or operation (XCEN=1).

Bit	Value	Definition
23	0	Specifies PLL frequency word.
22:20	IPART	Integer part of the PLL programming variable.
19:0	FPART	Fractional part of the PLL programming variable.

The frequency of the channel controlled by the configuration PLL Frequency Word, defined above, and the input reference frequency. The expression for the channel frequency is:

$$f_{ch} = \frac{3}{2} \cdot f_{ref} \left[H + I + \frac{N}{2^{20}} \right] \text{MHz}$$

where:

N=FPART (the fractional part of the DSM programming value),

I=IPART (the interger part of the DSM programming value),

H=DIVBASEOFFS + 122 for f_{ref} =12.288MHz (RATE=2, 3, or 4),

 DIVBASEOFFS + 107 for f_{ref} =13.824MHz (RATE=0 or 1),

DIVBASEOFF=a variable defined in Register 3 (default=8),

RATE=a variable defined in Register 0 (default=0),

f_{ref} =12.288MHz or 13.82MHz

Configuration Register Serial Word

The configuration registers are written only during standby mode (XCEN=0). These data registers are volatile and will erase when VCC is removed. The format is shown below:

Bit	Value	Definition
23	1	This is a configuration register transaction.
22	RESET	
21	1	Must be set to write to register.
20:16	ADDRESS	Register address (value=0, 1, 2, 3, or 4).
15:0	CDATA	Configuration Register data.

Value	Definition
0	Normal operation.
1	Perform reset operation. Must be asserted on first serial transfer.

All registers (R0, R1, R2, R3, and R4) will be loaded with default values and need to be initialized by the system baseband hardware for the data rate used. See Table 6 following this section.

Register 0

Register 0 is a special register because some of the hardware is controlled directly from this register. Since those specific bits are connected physically to active hardware, they must always be written first after power on. If register 0 is not initialized first by the baseband hardware the ML2730 will not operate correctly.

Bit	Variable	Default	Definition
15	UWDPOL	0	1: Invert the default DECT Unique Word (UWD) pattern. 0: Use the default DECT Unique Word (UWD) pattern.
14:12	TCMOD	0	Selects one of eight possible data slicer time constant combinations
11	PLLULACT	1	1: Invert the default DECT Unique Word (UWD) pattern. 0: Use the default DECT Unique Word (UWD) pattern.
10:8	RATE	0	Selects one of eight possible bit rate combinations. Selected bit rates are dependent on external crystal frequency supplied.
7	RESERVED	0	RESERVED
6	RESERVED	0	RESERVED
5:4	RESERVED	0	RESERVED
3:0	RESERVED	0xE	RESERVED

10:8 - RATE

Value	Definition
0	576 kbps (at 13.824 MHz)
1	1,152 kbps (at 13.82 MHz)
2	1,536 kbps (at 12.288 MHz)
3	1,755 kbps (at 12.288 MHz)
4	2,048 kbps (at 12.288 MHz)
5	Not defined.
6	Not defined.
7	Not defined.

11 - PLLULACT

Value	Definition
0	PA will always turn on.
1	If the PLL does not lock the PA does not turn on.

14:12 - TCMOD

Value	Definition
0	Forces 300 μS
1	Forces 6 μS
2	Forces 3 μS
3	Forces 2 μS
4	External selection between 300 μS and 6 μS
5	External selection between 300 μS and 3 μS
6	Use Unique Word Detect mode and force 6 μS
7	Use Unique Word Detect mode and forces 3 μS

Register 1

Bit	Variable	Default	Definition
15:12	CDRDLY	12	Recovered Data Clock Delay (RDC_{delay}) is the delay between the rising edge of RX data and the rising edge of the recovered RX data clock. The CDRDLY variable sets this delay as follow: $RDC_{delay} = CDRDLY / (2 \times f_{ref})$ [default $RDC_{delay} = 325\text{ms}$]
11:10	RXIADJMIX1	0, Value for RXIADJMIX1s/b:3	Current adjustment for RFRF 1st mixer.
9:8	RESERVED	3	RESERVED
7:6	RESERVED	2	RESERVED
5	TXFILTEDGE	0	1: clock TX data on the falling edge of the reference clock. 0: clock TX data on the rising edge of the reference clock.
4	TXFILTPOL	0	1: Invert the data before filtering. 0: no data inversion applied.
3	RSSIDLY	1	1: RSSI output is masked until the PLL is finished tuning. 0: RSSI will function during the PLL tuning change time.
2	UW1ERR	0	1: one error is allowed for the DECT unique word detection. 0: zero errors are allowed for the DECT unique word detection.
1:0	RESERVED	0	RESERVED

Reserved 11:10 - RXIADJMIX1

Value	Definition
0	Bias current setting=Nominal - 16.6%
1	Bias current setting=Nominal
2	Bias current setting =Nominal +16.6%
3	Bias current setting =Nominal +33.2%

Register 2

Bit	Variable	Default	Definition
15:14	RESERVED	1	RESERVED
13	AOUTEN	0	1: use the analog output 0: use the digital output
12:8	TTXONB	0	PA on to T/R switch delay (see Table 2)
7	CDREN	1	When set, enable CDR. When clear, CDR is not used.
6	PA2CTL	1	If clear, will not allow PA2 to power up. Otherwise, PA2 is powered on and off in tandem with PA1.
5:0	TTXONA	0	RX to TX delay time (see Table 2)

Register 3

Bit	Variable	Default	Definition
15:12	RESERVED	8	RESERVED
11:8	RESERVED	8	RESERVED
7:4	DIVBASEOFFS	8	Offset to integer portion of PLL programming.
3	PAFIRST	0	1: the PA turns on before the external switch controls change. 0: the external switch controls change before the PA is turned on.
2:1	TXOFF	0	PA off to T/R switch delay (see Table 2).
0	NOIVCOC	0	1: no incremental VCO calibration, only incremental IF calibration. 0: perform both VCO and IF incremental calibrations.

Register 4

Bit	Variable	Power-on Default	Rate Variable	Definition
15:8	MDCALV	0x38 0x45 0x5D 0x60 0x50 0x00 0x00 0x00	0 1 2 3 4 5 6 7	Frequency Modulation Deviation value. Small adjustments to MDCALV will tune the modulation spectrum. Note: At power-on, the MDCALV default value corresponding to the RATE variable of Register 0 is written to this register. Factory optimized values for MDCALV are shown in Table 6.
7:0	RESERVED	0		RESERVED

Recommended Configuration Register Values

Table 6: Recommended register values for each data rate

Register	Data Rate (kbps)				
	576	1152	1536	1755	2048
R0	087E	097E	0A7E	0B7E	0C7E
R1	0F88	FF88	CF88	BF88	9F88
R2	40C0	40C0	40C0	40C0	40C0
R3	8884	8884	8884	8884	8884
R4	6D02	4102	5302	6002	4F02
R5	C008	C008	C008	C008	C008

Please consult with an RFMD application engineer for updates to these values or if you have special configuration requirements. The recommended register settings in Table 6 initialize the ML2730 as follows:

- DOUT enabled (AOUT disabled)
- Force 300µs data slicer time constant
- CDR enabled
- RSSI muting while PLL is not locked
- 3.30V PA regulator
- Minimum RX to TX delay
- Minimum PA on to T/R switch delay
- Minimum PA off to T/R switch delay

Physical Dimensions

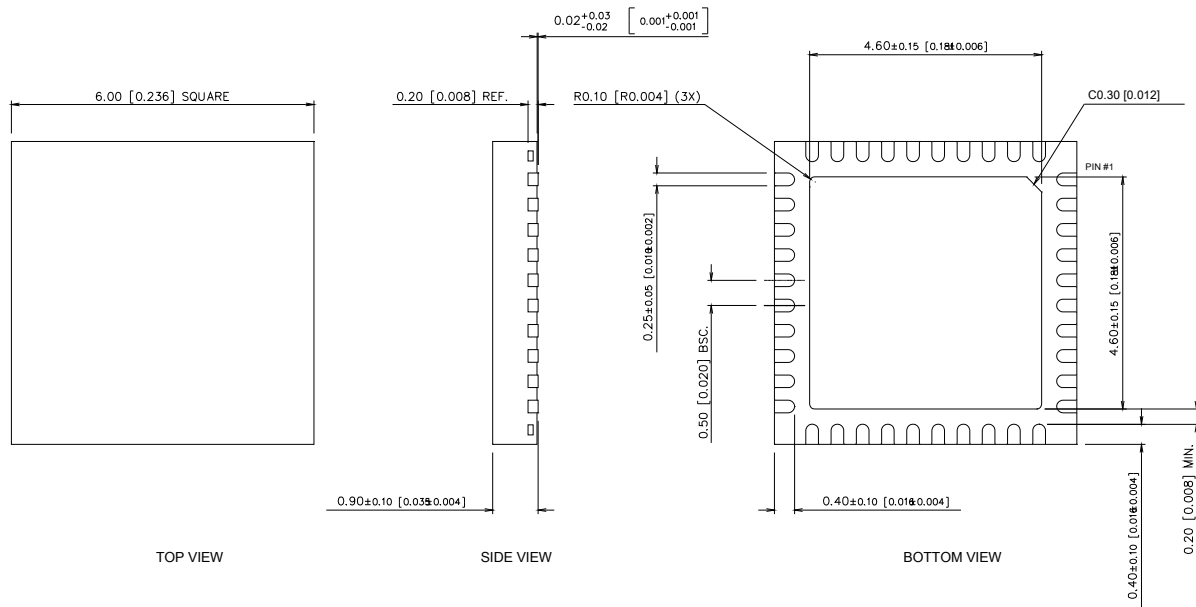

NOTES:
 1. JEDEC REFERENCE: MO-220 (VJJD-4)
 2. ALL DIMENSIONS ARE IN MM [INCHES].
 3. GENERAL TOLERANCE: ±0.05 [±0.002]

Figure 19: 40-Pin QFN Package Dimensions

Ordering Information

Part Number	Temp Range	Package	Pack (Qty)
ML2730DM-T	-10 °C to +80 °C	40 QFN 6mmx6mm	Tape and Reel (2500)
ML2730DM-SR	-10 °C to +80 °C	40 QFN 6mmx6mm	Short Reel (100)
ML2730DM-SQ	-10 °C to +80 °C	40 QFN 6mmx6mm	Antistatic Bag (25)
ML2730SK-03	-10 °C to +80 °C		
ML2730RDK-03	-10 °C to +80 °C		