



Features

- Frequency Range 10MHz to 850 MHz
- 6-Bit Digital Step Attenuator
- SPI Serial Control Programming
- Max Gain = 44dB at 150MHz
- Gain Control Range = 31.5dB (0.5dB Step Size)
- High OIP3 = 42dBm at 150MHz
- High P1dB = 20dBm at 150MHz
- Single +5V Supply
- Small 32-Pin, 5.2mm x 5.2mm, MCM
- Footprint Compatible with 5mm x 5mm, 32-Pin, QFN
- Power-up Programming

Applications

- Transceiver IF DVA
- Cellular, PCS, GSM, UMTS
- Wireless Data, Satellite Terminals

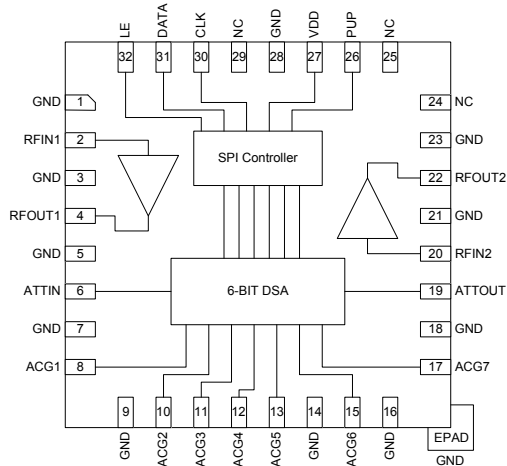

Functional Block Diagram

Product Description

RFMD's RFDA0045 is a digital controlled variable gain amplifier (DVGA) featuring high linearity over the entire gain control range. The 6-bit digital step attenuator is programmed with serial mode control interface. The RFDA0045 is packaged in a 5.2mmx5.2mm leadless laminate MCM with plated through thermal vias for low thermal resistance. The amplifiers' bias chokes and DC blocks are external allowing for optimum performance over specific bands within 10MHz to 850MHz.

Ordering Information

RFDA0045SQ	Sample Bag with 25 pieces
RFDA0045SR	7" Sample Reel with 100 pieces
RFDA0045T7	7" Reel with 750 pieces
RFDA0045TR13	13" Reel with 2500 Pieces
RFDA0045PCK-410	10 MHz to 850MHz PCBA with 5-piece sample bag

Optimum Technology Matching® Applied

- | | | | |
|---|--|--|-----------------------------------|
| <input type="checkbox"/> GaAs HBT | <input type="checkbox"/> SiGe BiCMOS | <input checked="" type="checkbox"/> GaAs pHEMT | <input type="checkbox"/> GaN HEMT |
| <input type="checkbox"/> GaAs MESFET | <input type="checkbox"/> Si BiCMOS | <input checked="" type="checkbox"/> Si CMOS | <input type="checkbox"/> RF MEMS |
| <input checked="" type="checkbox"/> InGaP HBT | <input checked="" type="checkbox"/> SiGe HBT | <input type="checkbox"/> Si BJT | <input type="checkbox"/> LDMOS |

Absolute Maximum Ratings

Parameter	Rating	Unit
DC Supply Voltage	+5.5	V
DS Supply Current	230	mA
Power Dissipation	1265	mW
Maximum Input RF Power	16	dBm
Operating Temperature (T _{CASE})	-40 to +85	°C
Storage Temperature	-40 to +150	°C
Junction Temperature	150	°C
ESD Rating (HBM)	500 (Class 1B)	V
Moisture Sensitivity Level	MSL 3	



Caution! ESD sensitive device.

Exceeding any one or a combination of the Absolute Maximum Rating conditions may cause permanent damage to the device. Extended application of Absolute Maximum Rating conditions to the device may reduce device reliability. Specified typical performance or functional operation of the device under Absolute Maximum Rating conditions is not implied.

RoHS status based on EUDirective2002/95/EC (at time of this document revision).

The information in this publication is believed to be accurate and reliable. However, no responsibility is assumed by RF Micro Devices, Inc. ("RFMD") for its use, nor for any infringement of patents, or other rights of third parties, resulting from its use. No license is granted by implication or otherwise under any patent or patent rights of RFMD. RFMD reserves the right to change component circuitry, recommended application circuitry and specifications at any time without prior notice.

Parameter	Specification			Unit	Condition
	Min.	Typ.	Max.		
Frequency	10		850	MHz	
Gain - 150MHz (Max Gain State)		44.5		dB	Attenuation=0dB, 150MHz
Gain - 500MHz (Max Gain State)		43.0		dB	Attenuation=0dB, 500MHz
Gain - 850MHz (Max Gain State)		41.5		dB	Attenuation=0dB, 850MHz
Gain Control Range		31.5		dB	
Step Accuracy	+/- (0.15+5% attenuation setting)			dB	Major States, up to 850MHz
Output P1dB		19.5		dBm	Attenuation = 0dB, 50MHz to 850MHz
Output IP3 - 150MHz		42		dBm	P _{OUT} =0dBm/tone, 1MHz Spacing, 150MHz
Output IP3 - 500MHz		38		dBm	P _{OUT} =0dBm/tone, 1MHz Spacing, 500MHz
Output IP3 - 850MHz		35		dBm	P _{OUT} =0dBm/tone, 1MHz Spacing, 850MHz
Noise Figure		2.4		dBm	Attenuation = 0dB
Input Return Loss		14.5		dB	10MHz to 500MHz, Slight Degradation Elsewhere
Output Return Loss		20		dB	10MHz to 500MHz, Slight Degradation Elsewhere
Settling Time				ns	t _{RISE} , t _{FALL} (10%/90% RF)
Control Interface		6		bit	SPI Interface
Impedance		50		Ω	
Supply Voltage	4.75	5.0	5.25	V	Recommended Operating Voltage
Total Supply Current		155	170	mA	Sum of V _{DD} , V _{CC_AMP1} , V _{CC_AMP2} (RF _{OUT})
Thermal Resistance				°C/W	

Notes:

- V_{DD} = 5V, Logic Voltage = 5V, T = 25 °C.
- Broadband Application Circuit.

Typical RF Performance at Key Operating Frequencies

Parameter	Unit	50 MHz	150MHz	500MHz	850MHz
Max Small Signal Gain	dB	44.4	44	42.6	41
Output P1dB	dBm	19.7	20	20	20
Output IP3 ¹	dBm	41	42	40	36
Input Return Loss	dB	17.5	18	13.6	10.6
Output Return Loss	dB	27	23	32	12.2
Noise Figure ²	dB	2.3	2.3	2.4	2.4

Notes:

- P_{OUT} = 0 dBm/tone, 1 MHz Spacing.
- Attenuation = 0dB

Typical Performance: 10MHz to 850MHz Broadband Application Circuit (25 °C)

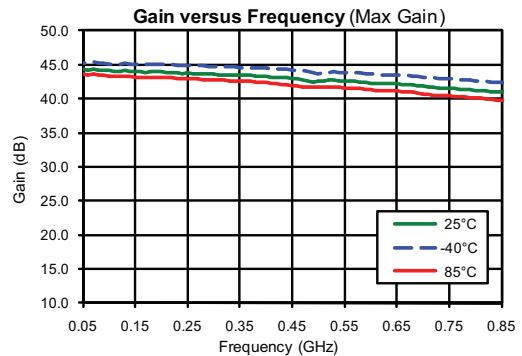
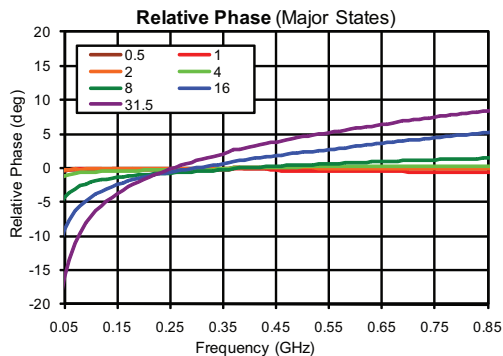
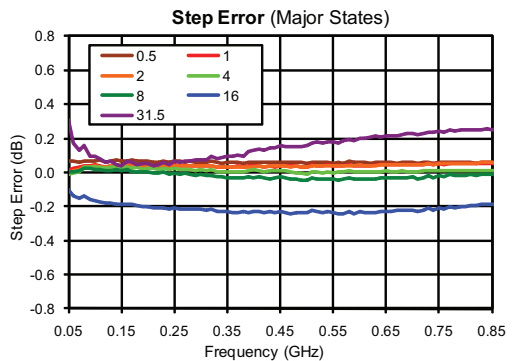
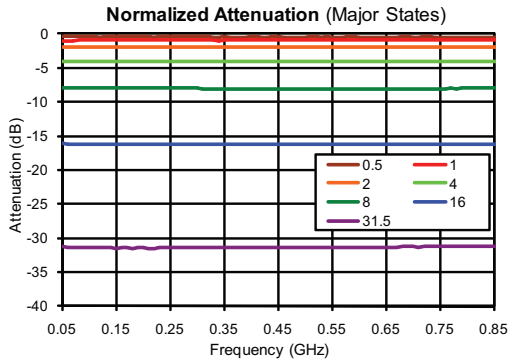
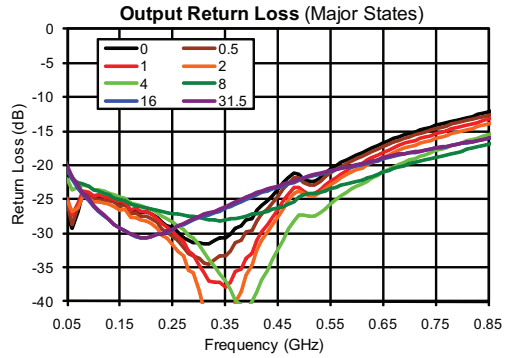
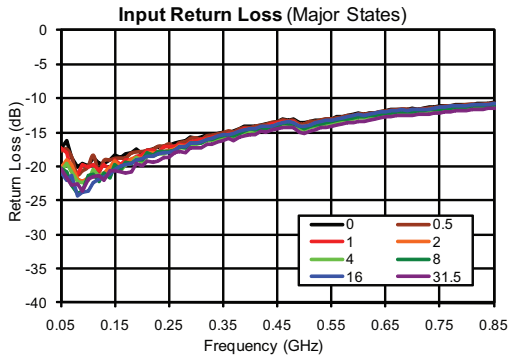

Typical Performance: 10MHz to 850MHz Broadband Application Circuit (25 °C)

Worst Case Successive Step Error

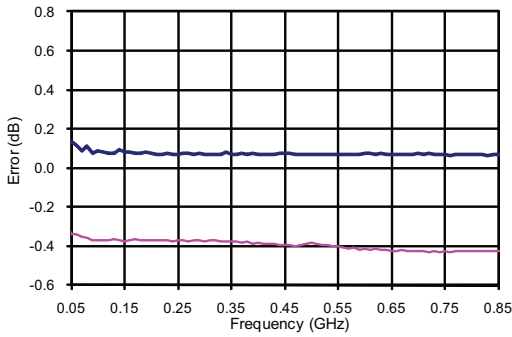

Successive Step Error versus Attenuation at 25°C

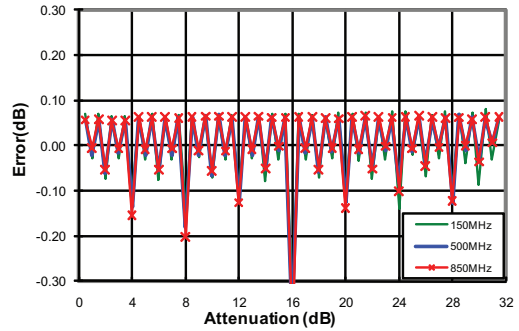

OIP3 (Major States, 25°C, 0dBm/Tone)

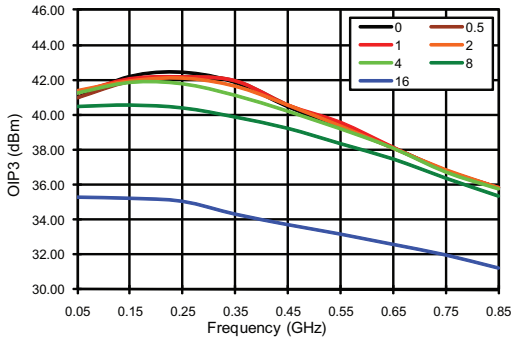

P1dB (Major States, 25°C)

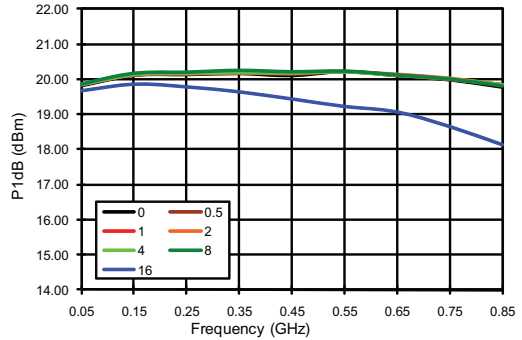

Noise Figure versus Frequency (Max Gain)

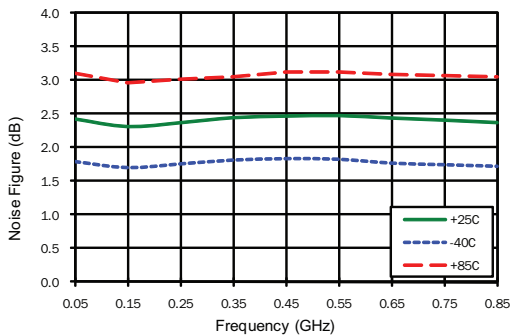

OIP3 versus P_{OUT} (Max Gain, at 150MHz)

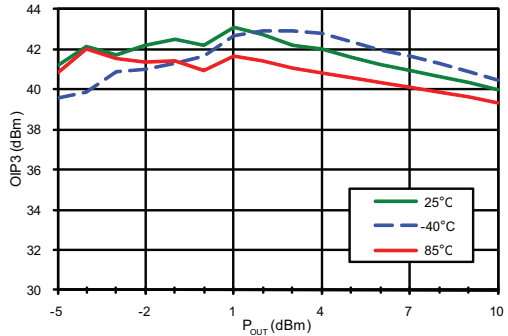

Serial Port Interface

SPI Timing Diagram

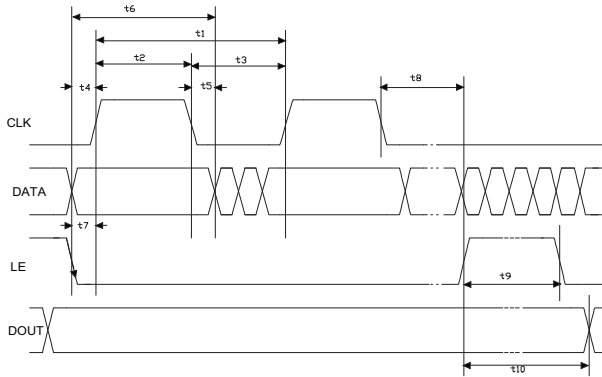

Programming Example, 6-Bit

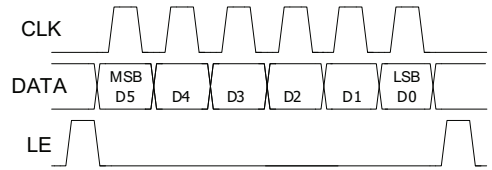

SPI Timing Diagram Specifications

Parameter	Limit	Unit	Comment
t1	25	MHz max	CLK Frequency
t2	20	ns min	CLK High
t3	20	ns min	CLK Low
t4	5	ns min	DATA to CLK Setup Time
t5	5	ns min	DATA to CLK Hold Time
t6	30	ns min	DATA Valid
t7	5	ns min	LE to CLK Setup Time
t8	5	ns min	CLK to LE Setup Time
t9	10	ns min	LE Pulse Width
t10	20	ns max	Output Set

Truth Table

Control Bit						Gain Relative to Maximum Gain
D5	D4	D3	D2	D1	D0	
1	1	1	1	1	1	0 dB
1	1	1	1	1	0	-0.5 dB
1	1	1	1	0	1	-1 dB
1	1	1	0	1	1	-2 dB
1	1	0	1	1	1	-4 dB
1	0	1	1	1	1	-8 dB
0	1	1	1	1	1	-16 dB
0	0	0	0	0	0	-31.5 dB

Power-up Programming Truth Table	
PUP	Attenuator Setting
High	Attenuation at min, 0dB
Low	Attenuation at max, 31.5dB

Logic Voltage Levels	
State	Logic
Low	0V to 0.8V
High	2.0V to 5.0V

Pin Names and Descriptions

Pin #	Pin Name	Description
1	GND	RF/DC Ground Connection
2	RFIN1	RF Input for Amplifier 1
3	GND	RF/DC Ground Connection
4	RFOUT1	RF Output/Bias for Amplifier 1
5	GND	RF/DC Ground Connection
6	ATTIN	RF Input for Digital Step Attenuator
7	GND	RF/DC Ground Connection
8	ACG1	AC Ground *
9	GND	RF/DC Ground Connection
10	ACG2	AC Ground *
11	ACG3	AC Ground *
12	ACG4	AC Ground *
13	ACG5	AC Ground *
14	GND	RF/DC Ground Connection
15	ACG6	AC Ground *
16	GND	RF/DC Ground Connection
17	ACG7	AC Ground *
18	GND	RF/DC Ground Connection
19	ATTOUT	RF Output for Digital Step Attenuator
20	RFIN2	RF Input for Amplifier 2
21	GND	RF/DC Ground Connection
22	RFOUT2	RF Output/Bias for Amplifier 2
23	GND	RF/DC Ground Connection
24	NC	No Internal Connection
25	NC	No Internal Connection
26	PUP	Power-up Programming Pin
27	VDD	Supply Voltage
28	GND	RF/DC Ground Connection
29	NC	No Internal Connection
30	CLK	Serial Clock
31	DATA	Serial Data Input
32	LE	Latch Enable

* External capacitors to ground are recommended for frequency operation below 500MHz and place capacitor as close to pins as possible. For operation >500MHz, these pins may be left unconnected.

Evaluation Board Schematic

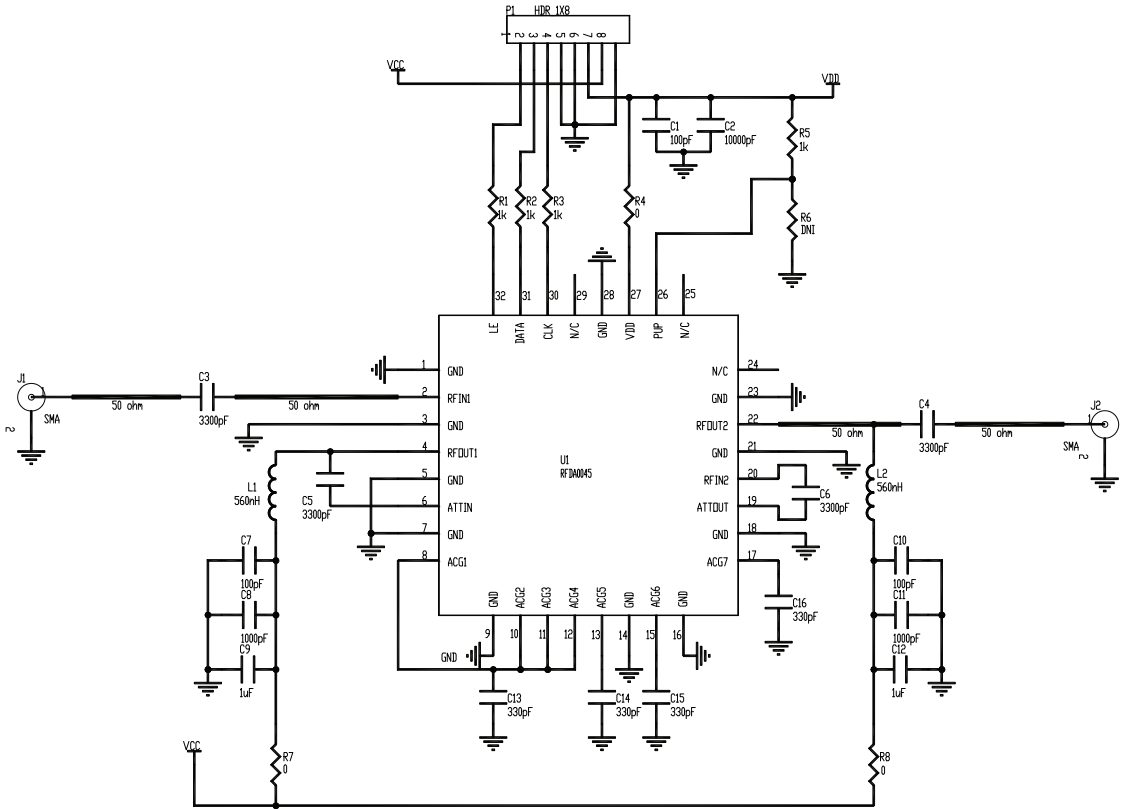

Evaluation Board Build of Materials (BOM)

Description	Reference Designator	Manufacturer	Manufacturer's P/N
Evaluation Board			RFDA0045410(A)
Digital Controlled Variable Gain Amplifier	U1	RFMD	RFDA0045SB
CAP, 100pF, 5%, 50V, COG, 0402	C1, C7, C10	Murata Electronics	GRM1555C1H101JZ01D
CAP, 10000pF, 10%, 16V, X7R, 0402	C2	Taiyo Yuden (USA), Inc.	RM EMK105BJ103KV-F
CAP, 3300pF, 10%, 50V, X7R, 0402	C3-C6	Taiyo Yuden (USA), Inc.	RM UMK105BJ332KV-F
CAP, 1000pF, 10%, 50V, X7R, 0402	C8, C11	Taiyo Yuden (USA), Inc.	RM UMK105BJ102KV-F
CAP, 1uF, 10%, 16V, X7R, 0603	C9, C12	Murata Electronics	GRM188R71C105KA12D
CAP, 330pF, 10%, 50V, X7R, 0402	C13-C16	Taiyo Yuden (USA), Inc.	RM UMK105BJ331KV-F
CONN, HDR, ST, 8-PIN, 0.100"	P1	SAMTEC INC.	TSW-108-07-G-S
CONN, SMA, END LNCH, RND PIN, 0.059"	J1-J2	GIGALANE CO., LTD.	PSF-S01-006
IND, 560nH, 10%, W/W, 0805	L1-L2	Coilcraft, Inc.	0805CS-561XJBC
RES, 1K, 5%, 1/16W, 0402	R1-R3, R5	Kamaya, Inc	RMC1/16S-102JTH
RES, 0Ω, 0402	R4	Kamaya, Inc	RMC1/16SJPTH
RES, 0Ω, 0603	R7-R8	Kamaya, Inc	RMC1/16JPTP
DNI	R6, J3-J4		

Evaluation Board Assembly Drawing

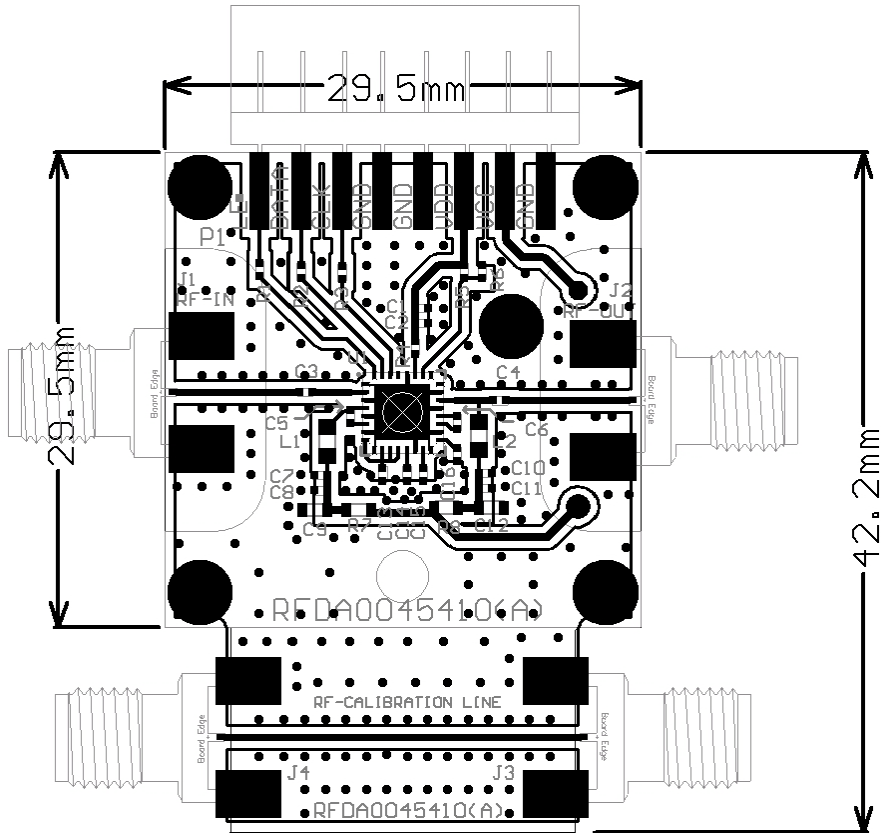

Package Drawing 5.2mm x 5.2mm Laminate Module

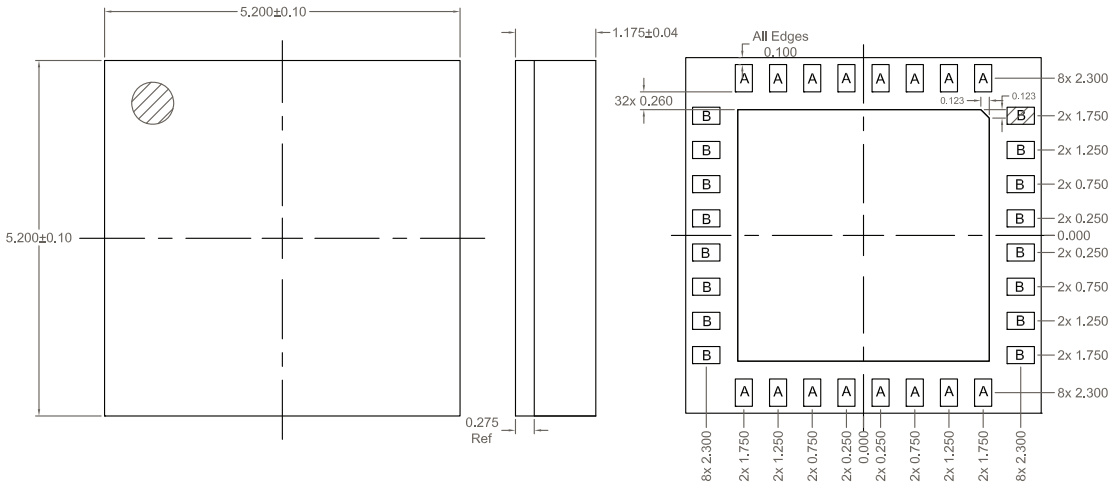

Notes:

1. Shaded area represents Pin 1 location

A = 0.250 x 0.400 mm
 B = 0.400 x 0.250 mm
 C = 3.680 x 3.680 mm