



Product Description

RFMD's SGC-6389Z is a high performance SiGe HBT MMIC amplifier utilizing a Darlington configuration with a patented active-bias network. The active bias network provides stable current over temperature and process Beta variations. Designed to run directly from a 5V supply, the SGC-6389Z does not require a dropping resistor as compared to traditional Darlington amplifiers. The SGC-6389Z product is designed for high linearity 5V gain block applications that require small size and minimal external components. It is internally matched to 50Ω.

Optimum Technology Matching® Applied

- GaAs HBT
- GaAs MESFET
- InGaP HBT
- SiGe BiCMOS
- Si BiCMOS
- SiGe HBT
- GaAs pHEMT
- Si CMOS
- Si BJT
- GaN HEMT
- InP HBT
- RF MEMS
- LDMOS

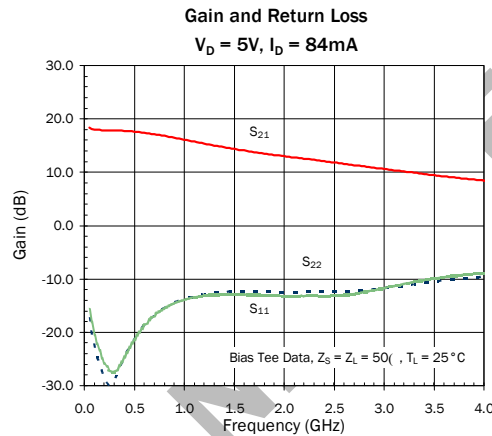

Features

- Single Fixed 5V Supply
- No Dropping Resistor Required
- Patented Self Bias Circuitry
- Gain = 12.8dBm at 1950MHz
- P1dB = 18.6dBm at 1950MHz
- OIP3 = 34.5dBm at 1950MHz
- Robust 1000V ESD, Class 1C HBM

Applications

- PA Driver Amplifier
- Cellular, PCS, GSM, UMTS, WCDMA
- IF Amplifier
- Wireless Data, Satellite

Parameter	Specification			Unit	Condition
	Min.	Typ.	Max.		
Small Signal Gain	14.8	16.3	17.8	dB	850MHz
	11.3	12.8	14.3	dB	1950MHz*
		11.9		dB	2400MHz
Output Power at 1dB Compression		19.5		dBm	850MHz
	17.6	18.6		dBm	1950MHz*
		18.2		dBm	2400MHz
Output Third Order Intercept Point		36.0		dBm	850MHz
	32.5	34.5		dBm	1950MHz*
		33.5		dBm	2400MHz
Input Return Loss	9.0	12.5		dB	1950MHz*
Output Return Loss	8.5	11.5		dB	1950MHz*
Noise Figure		3.7	4.5	dB	1950MHz
Thermal Resistance		60		°C/W	junction - lead
Device Operating Voltage		5.0		V	
Device Operating Current	74.0	84.0	94.0	mA	

Test Conditions: $V_D = 5V, I_D = 84mA$ Typ., OIP3 Tone Spacing = 1MHz, P_{OUT} per tone = 0dBm, Bias Tee Data, $Z_S = Z_L = 50\Omega$,
 *Test results at 1950MHz measured with Application Circuit

Absolute Maximum Ratings

Parameter	Rating	Unit
Device Current (I_{CE})	120	mA
Device Voltage (V_{CE})	6.5	V
RF Input Power* (See Note)	8	dBm
Junction Temp (T_J)	+150	°C
Operating Temp Range (T_L)	-40 to +85	°C
Storage Temp	+150	°C
ESD Rating - Human Body Model (HBM)	Class 1C	
Moisture Sensitivity Level	MSL 2	

*Note: Load condition $Z_L = 50\Omega$.

Operation of this device beyond any one of these limits may cause permanent damage. For reliable continuous operation, the device voltage and current must not exceed the maximum operating values specified in the table on page one.

Bias Conditions should also satisfy the following expression:

$$I_D V_D < (T_J - T_L) / R_{TH, J - I} \text{ and } T_L = T_{LEAD}$$



Caution! ESD sensitive device.

Exceeding any one or a combination of the Absolute Maximum Rating conditions may cause permanent damage to the device. Extended application of Absolute Maximum Rating conditions to the device may reduce device reliability. Specified typical performance or functional operation of the device under Absolute Maximum Rating conditions is not implied.

The information in this publication is believed to be accurate and reliable. However, no responsibility is assumed by RF Micro Devices, Inc. ("RFMD") for its use, nor for any infringement of patents, or other rights of third parties, resulting from its use. No license is granted by implication or otherwise under any patent or patent rights of RFMD. RFMD reserves the right to change component circuitry, recommended application circuitry and specifications at any time without prior notice.



RFMD Green: RoHS compliant per EU Directive 2002/95/EC, halogen free per IEC 61249-2-21, < 1000ppm each of antimony trioxide in polymeric materials and red phosphorus as a flame retardant, and <2% antimony in solder.

Typical RF Performance at Key Operating Frequencies (Bias Tee Data)

Parameter	Unit	50 MHz	100 MHz	500 MHz	850 MHz	1950 MHz*	2400 MHz	3500 MHz
Small Signal Gain (G)	dB	18.4	18.0	17.6	16.3	12.8	11.9	9.4
Output Third Order Intercept Point (OIP_3)	dBm	36.0	36.5	35.5	36.0	34.5	33.5	30.5
Output Power at 1dB Compression (P_{1dB})	dBm	20.7	20.4	19.9	19.5	18.6	18.2	16.5
Input Return Loss (IRL)	dB	17.5	23.0	21.5	15.5	12.5	12.0	10.5
Output Return Loss (ORL)	dB	15.5	21.0	22.0	15.5	11.5	12.0	10.0
Reverse Isolation (S_{12})	dB	20.5	20.0	21.0	21.5	19.5	19.0	18.5
Noise Figure (NF)	dB	2.8	2.6	2.9	3.3	3.7	4.0	4.7

Test Conditions: $V_D = 5V$ $I_D = 84mA$ OIP_3 Tone Spacing = 1MHz, P_{OUT} per tone = 0dBm

$T_L = 25^\circ C$ $Z_S = Z_L = 50\Omega$ *Test results at 1950MHz measured with Application Circuit

Typical Performance with Bias Tees, $V_D = 5V$, $I_D = 84mA$

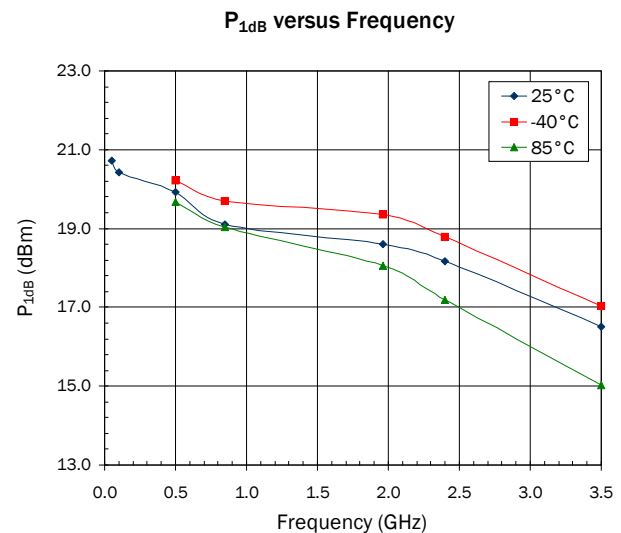
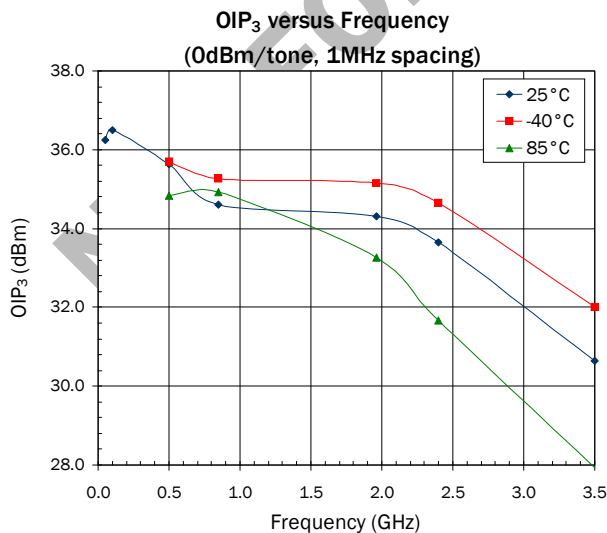

Typical Performance with Bias Tees, $V_D = 5V$, $I_D = 84mA$

Noise Figure vs. Frequency

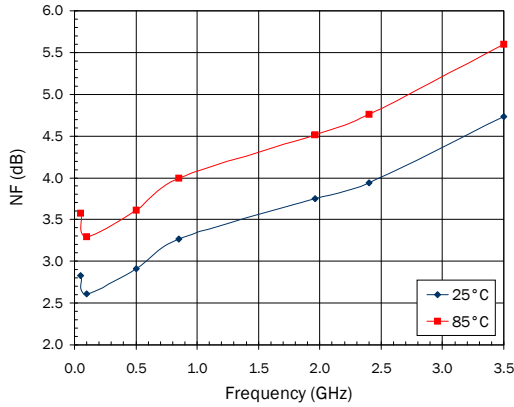

Current versus Voltage

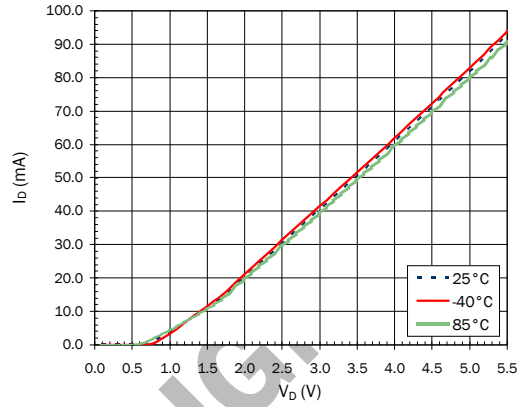

S_{11} versus Frequency

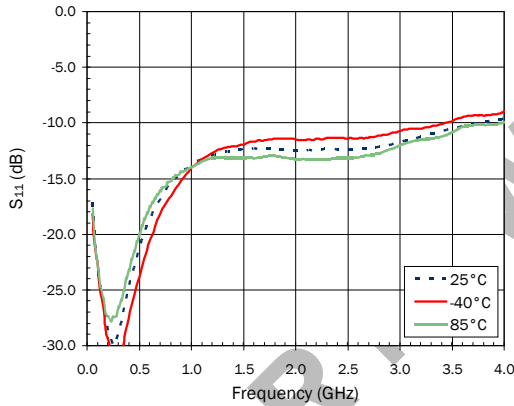

S_{21} versus Frequency

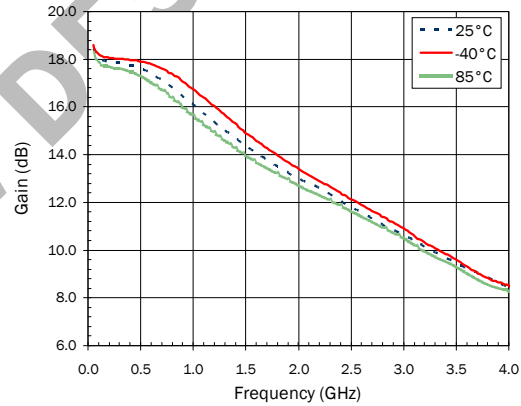

S_{12} versus Frequency

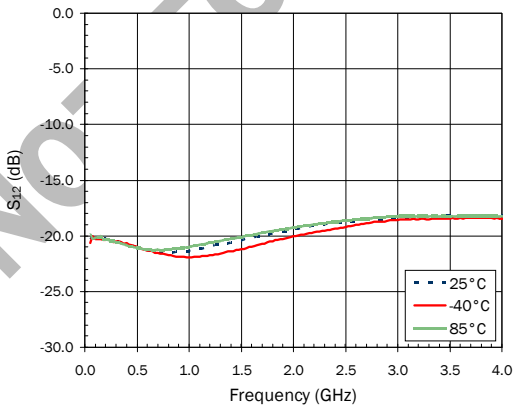

S_{22} versus Frequency

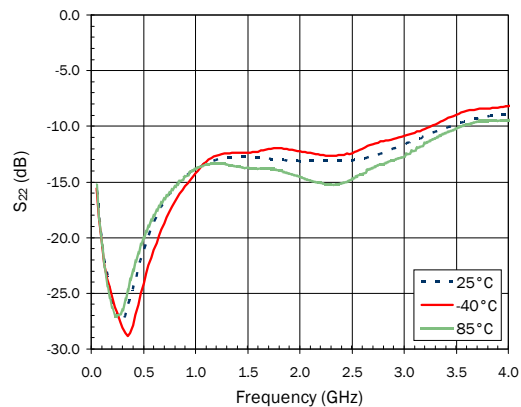

Pin	Function	Description
1	RF IN	RF input pin. This pin requires the use of an external DC blocking capacitor chosen for the frequency of operation.
2, 4	GND	Connection to ground. Use via holes as close to the device ground leads as possible to reduce ground inductance and achieve optimum RF performance.
3	RF OUT/DC BIAS	RF output and bias pin. This pin requires the use of an external DC blocking capacitor chosen for the frequency of operation.

SOT-89 PCB Pad Layout

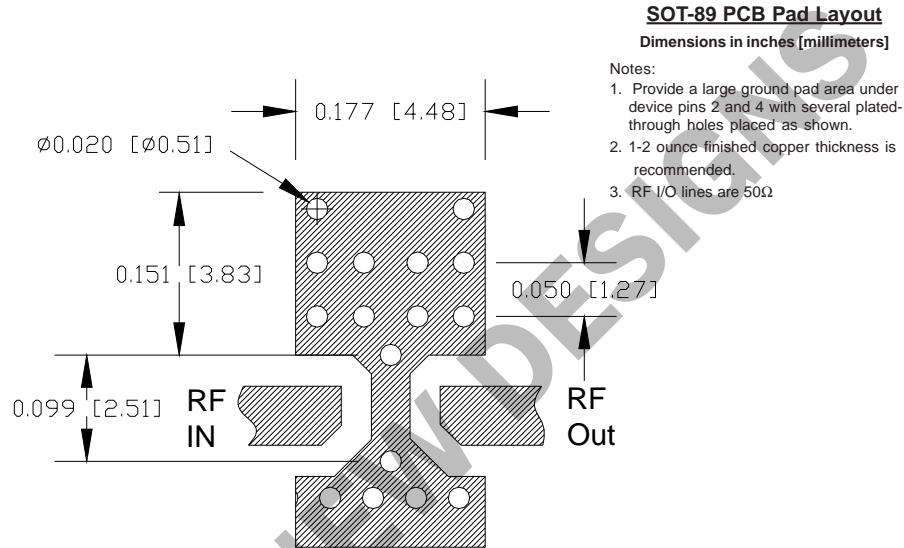

SOT-89 Nominal Package Dimensions

Dimensions in inches (millimeters)

Refer to drawing posted at www.rfmd.com for tolerances.

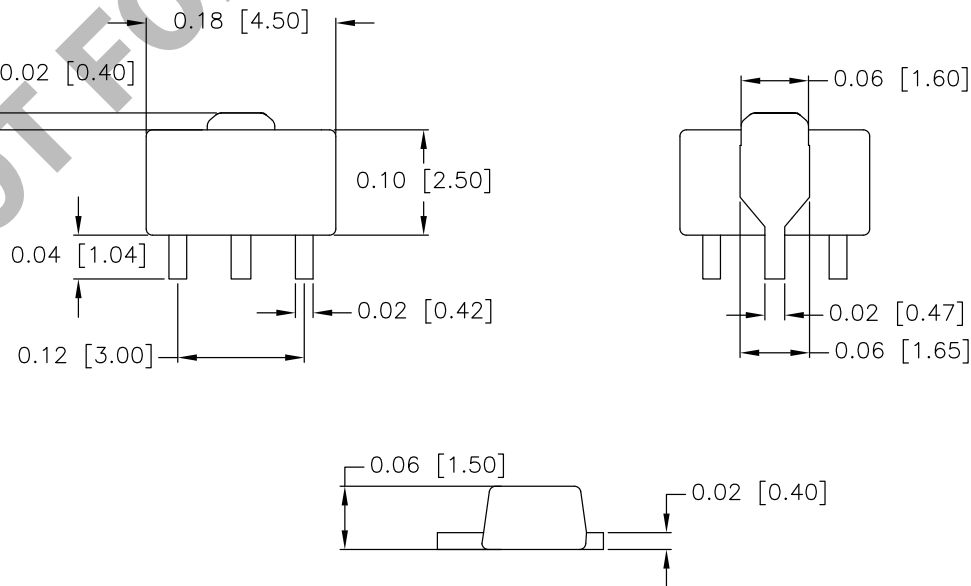

Application Schematic

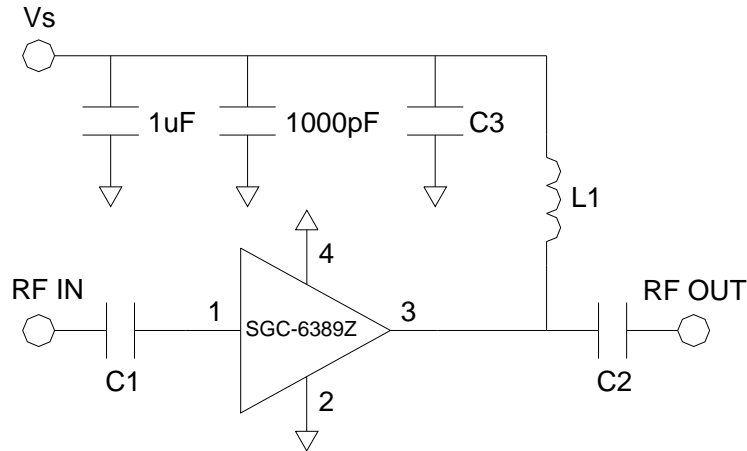

Application Circuit Element Values		
Reference Designator	100-1000MHz	1000-2200MHz
C1	1000pF	6.8pF
C2	100pF	6.8pF
C3	100pF	6.8pF
L1	100nH	39nH

Evaluation Board Layout

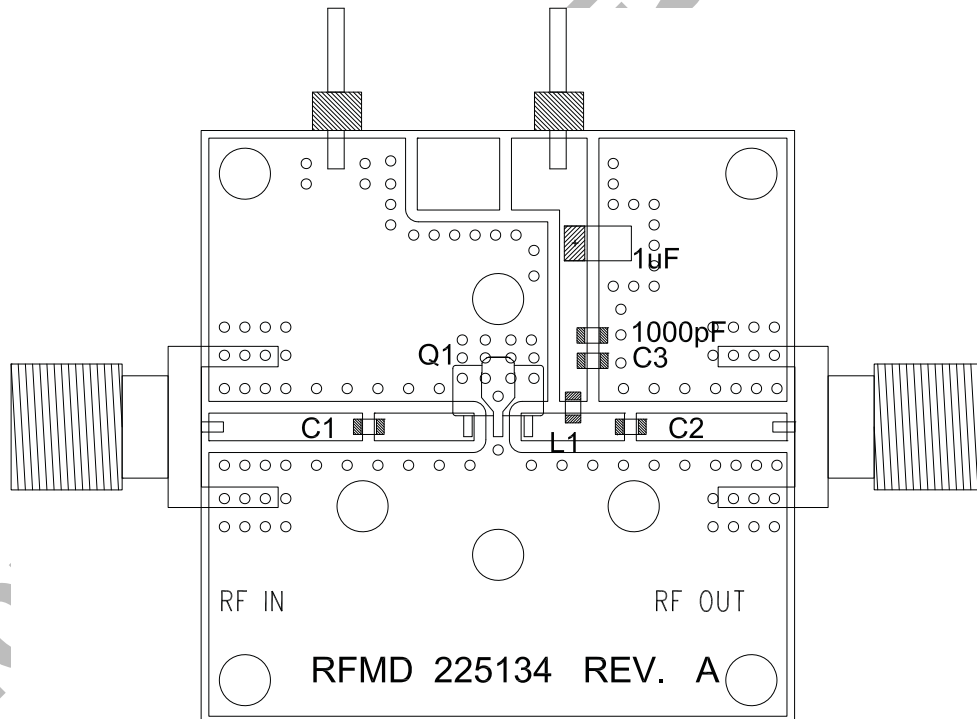

Part Identification

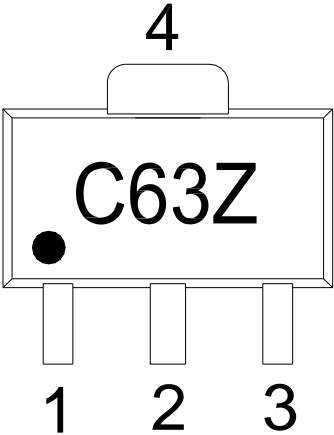

Alternate marking "SGC6389Z" on line one with Trace Code on line two.

Part / Evaluation Board Ordering Information			
Part Number	Description	Reel Size	Devices / Reel
SGC-6389Z	Lead Free, RoHs Compliant	13"	3000
SGC-6389Z-EVB1	100-1000 MHz Evaluation Board	N/A	N/A
SGC-6389Z-EVB2	1000-2200 MHz Evaluation Board	N/A	N/A

DESIGNS
NOT FOR