

Package: QFN, 6mmx6mm



Product Description

RFMD's SZM-2066Z is a high linearity class AB Heterojunction Bipolar Transistor (HBT) amplifier housed in a low-cost surface-mountable plastic Q-FlexN multi-chip module package. This HBT amplifier is made with InGaP on GaAs device technology and fabricated with MOCVD for an ideal combination of low cost and high reliability. This product is specifically designed as a final or driver stage for 802.16 and 802.11b/g equipment in the 2.4GHz to 2.7GHz bands. It can run from a 3V to 5V supply. The external output match and bias adjustability allows load line optimization for other applications or over narrower bands. It features an output power detector, on/off power control and high RF overdrive robustness. A 20dB step attenuator feature can be utilized by switching the second stage Power up/down control.

Optimum Technology Matching® Applied

- GaAs HBT
- GaAs MESFET
- InGaP HBT
- SiGe BiCMOS
- Si BiCMOS
- SiGe HBT
- GaAs pHEMT
- Si CMOS
- Si BJT
- GaN HEMT
- InP HBT
- RF MEMS
- LDMOS

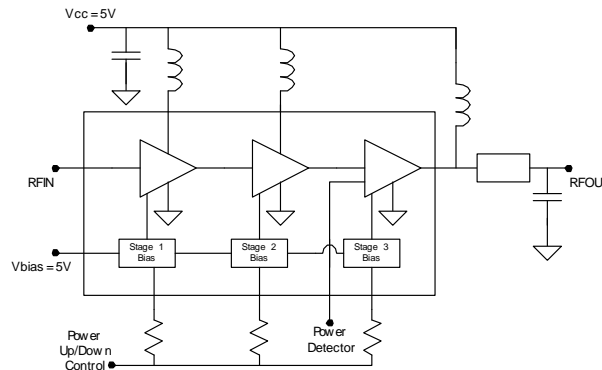

Features

- $P_{1dB} = 33.5\text{dBm}$ at 5V
- Three Stages of Gain: 37 dB
- 802.11g 54 Mb/s Class AB Performance
- $P_{OUT} = 26\text{dBm}$ at 2.5% EVM, VCC 5V, 690mA
- Active Bias with Adjustable Current
- On-Chip Output Power Detector
- Low Thermal Resistance
- Power Up/Down Control $< 1\mu\text{s}$
- Attenuator Step 20dB at $V_{PC2} = 0V$

Applications

- 802.16 WiMAX Driver or Output Stage
- 802.11b/g WiFi, WiFi

Parameter	Specification			Unit	Condition
	Min.	Typ.	Max.		
Frequency of Operation	2500		2700	MHz	
Output Power at 1dB Compression	32.0	33.5		dBm	2.7GHz
Small Signal Gain	32.2	33.7		dB	2.7GHz
EVM		2.5		%	2.7GHz, 802.11g 54Mb/s at $P_{OUT} = 26\text{dBm}$
Third Order Suppression		-45.0	-40.0	dBc	2.7GHz, $P_{OUT} = 23\text{dBm}$ per tone
Noise Figure		7.7		dB	2.7GHz
Worst Case Input Return Loss	7.5	10.5		dB	2.5GHz to 2.7GHz
Worst Case Output Return Loss	12.5	15.5		dB	2.5GHz to 2.7GHz
Output Voltage Range		0.9 to 1.8		V	$P_{OUT} = 10\text{dBm}$ to 33dBm
Quiescent Current	454	583	659	mA	$V_{CC} = 5V$
Power Up Control Current		4.0		mA	$V_{PC} = 5V, I_{VPC1} + I_{VPC2} + I_{VPC3}$
VCC Leakage Current			100	μA	$V_{CC} = 5V, V_{PC} = 0V$
Thermal Resistance		12.0		$^{\circ}\text{C}/\text{W}$	junction - lead

Test Conditions: $Z_0 = 50\Omega, V_{CC} = 5V, I_Q = 583\text{mA}, T_{BP} = 30^{\circ}\text{C}$

Absolute Maximum Ratings

Parameter	Rating	Unit
VC3 Collector Bias Current (I_{VC3})	1500	mA
VC2 Collector Bias Current (I_{VC2})	500	mA
VC1 Collector Bias Current (I_{VC1})	150	mA
*** Device Voltage (V_D)	9.0	V
Power Dissipation	6	W
***Max CW RF output Power for 50W continuous long term operation	30	dBm
Max CW RF output Power for 50Ω output load	26	dBm
Max CW RF Input Power for 10:1 VSWR out load	5	dBm
Storage Temperature Range	-40 to +150	°C
Operating Temp Range (T_L)	-40 to +85	°C
Operating Junction Temperature (T_J)	+150	°C
ESD Rating - Human Body Model	1000	V

***With specified application circuit

***No RF Drive

Operation of this device beyond any one of these limits may cause permanent damage. For reliable continuous operation, the device voltage and current must not exceed the maximum operating values specified in the table on page one.

Bias Conditions should also satisfy the following expression:

$$I_D V_D < (T_J - T_L) / R_{TH, j}$$



Caution! ESD sensitive device.

Exceeding any one or a combination of the Absolute Maximum Rating conditions may cause permanent damage to the device. Extended application of Absolute Maximum Rating conditions to the device may reduce device reliability. Specified typical performance or functional operation of the device under Absolute Maximum Rating conditions is not implied.

RoHS status based on EU Directive 2002/95/EC (at time of this document revision).

The information in this publication is believed to be accurate and reliable. However, no responsibility is assumed by RF Micro Devices, Inc. ("RFMD") for its use, nor for any infringement of patents, or other rights of third parties, resulting from its use. No license is granted by implication or otherwise under any patent or patent rights of RFMD. RFMD reserves the right to change component circuitry, recommended application circuitry and specifications at any time without prior notice.

Typical Performance with appropriate app circuit ($V_{CC}=5V$, $I_{CQ}=583mA$, *802.11g 54Mb/s 64QAM)

Parameter	Unit	**2.4 GHz	2.5 GHz	2.6 GHz	2.7 GHz
Gain @ $P_{OUT}=26dBm$	dB	37.5	36.9	36.5	34.6
P1dB	dBm	34.6	33.5	33.5	33.9
P_{OUT} @ 2.5% EVM*	dBm	27.0	26.0	26.0	26.5
Current @ P_{OUT} 2.5% EVM*	mA	703	710	700	712
Input Return Loss	dB	-12.1	-11.5	-10.8	-10.5
Output Return Loss	dB	-27	-15.6	-28	-18.5
Step Attenuation ($V_{PC2}=0V$)	dB	27	27	26	25

Test Conditions: **Measured with 2.4GHz to 2.5GHz Application circuit.

Simplified Device Schematic

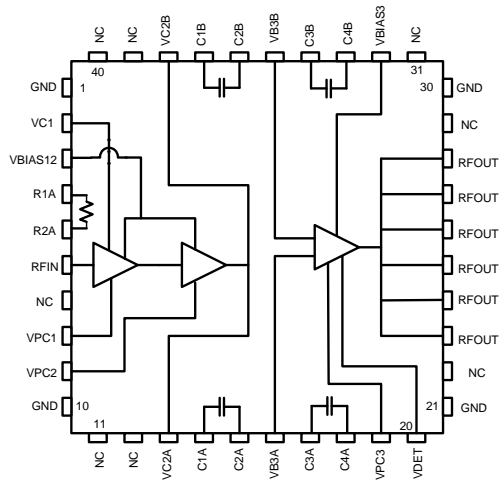

Measured 2.4GHz to 2.5GHz Application Circuit Data ($V_{CC}=V_{PC}=5.0V$, $I_Q=556mA$, $T=25^\circ C$)

EVM vs Pout T=+25c
802.11g, OFDM 54Mb/S, 64QAM

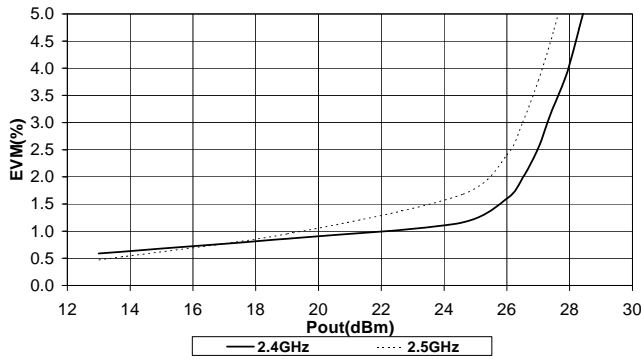

EVM vs Pout F=2.4GHz
802.11g, OFDM 54Mb/S, 64QAM

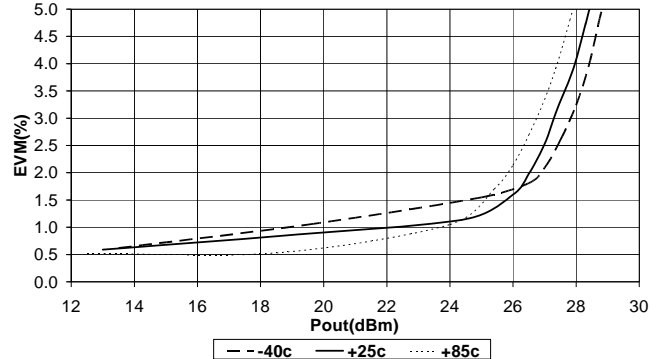

EVM vs Pout F=2.5GHz
802.11g, OFDM 54Mb/S, 64QAM

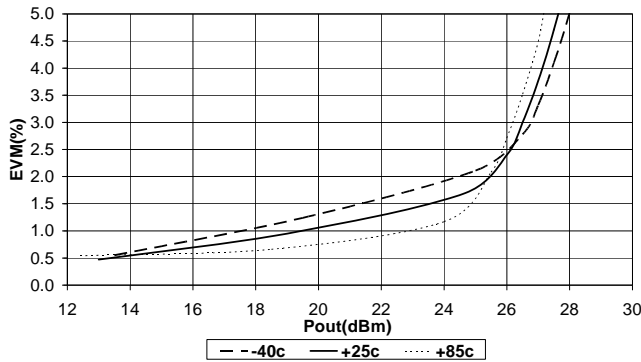

IM3 vs Pout (2 Tone Avg.), T=+25c
Tone Spacing = 1MHz

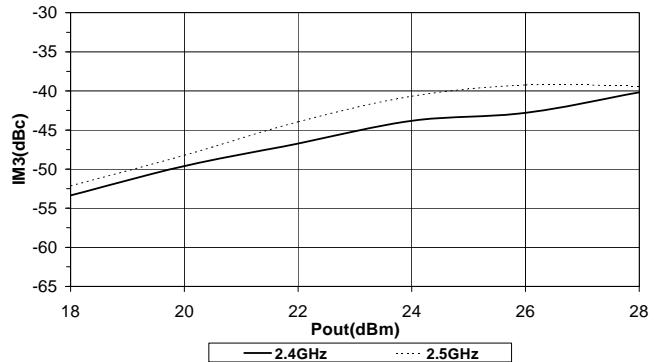

Typical Gain vs Pout, F=2.4GHz

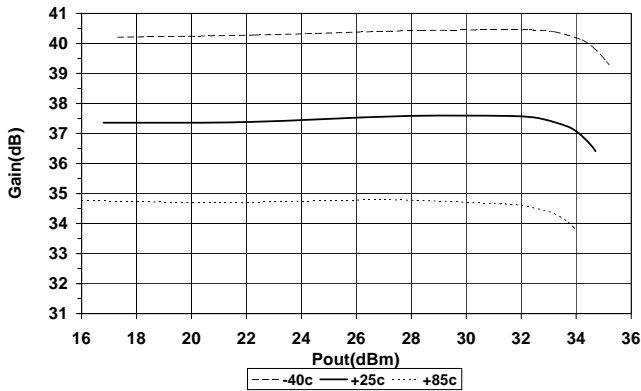

Typical Gain vs Pout, F=2.5GHz

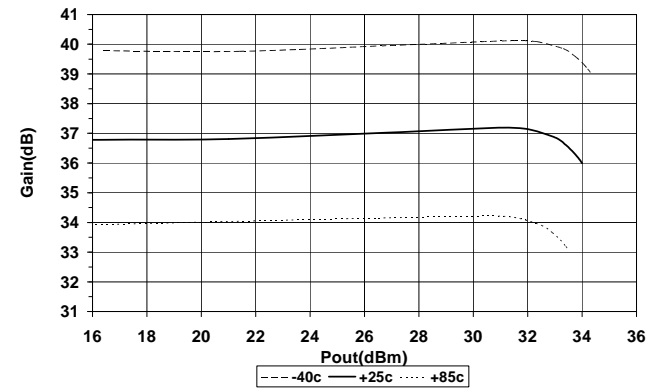

Measured 2.4GHz to 2.5GHz Application Circuit Data ($V_{CC}=V_{PC}=5.0V$, $I_Q=556mA$, $T=25^\circ C$)

Narrowband S11 - Input Return Loss

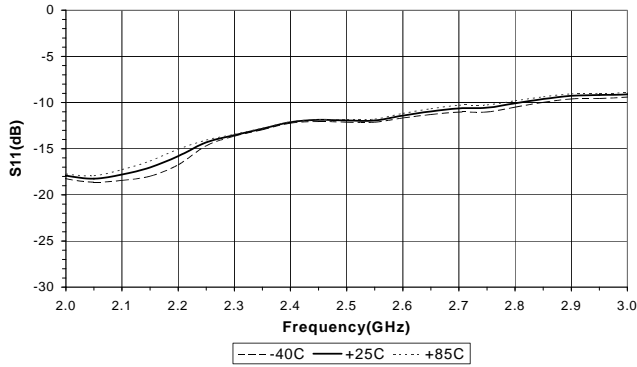

Narrowband S12 - Reverse Isolation

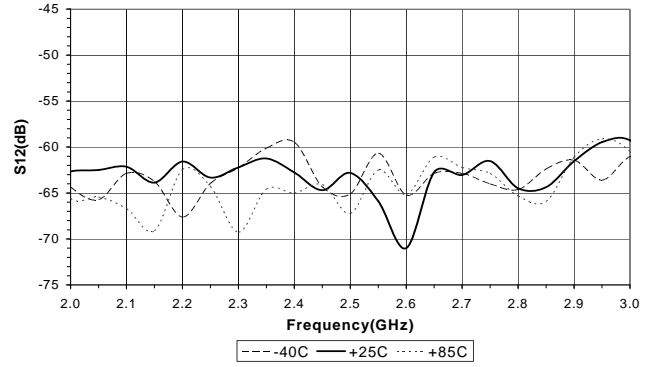

Narrowband S21 - Forward Gain

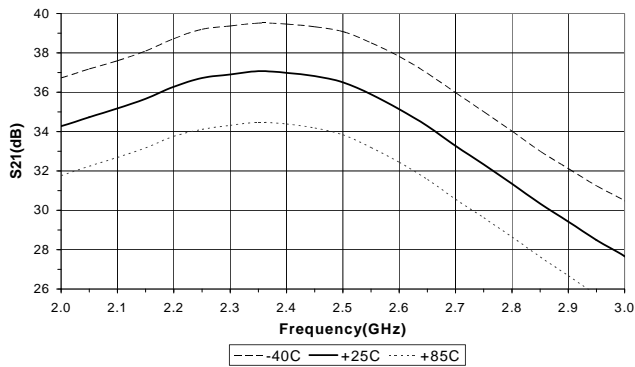

Narrowband S22 - Output Return Loss

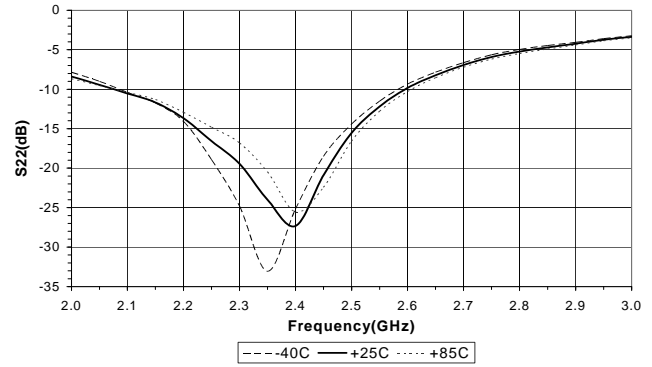

DC Supply Current vs Pout, T=+25C

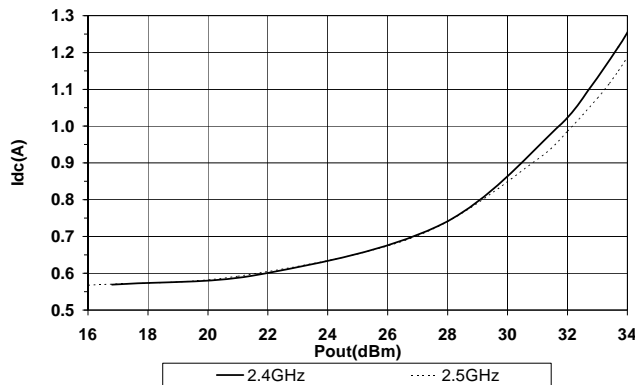

DC Supply Current vs Pout, F=2.4GHz

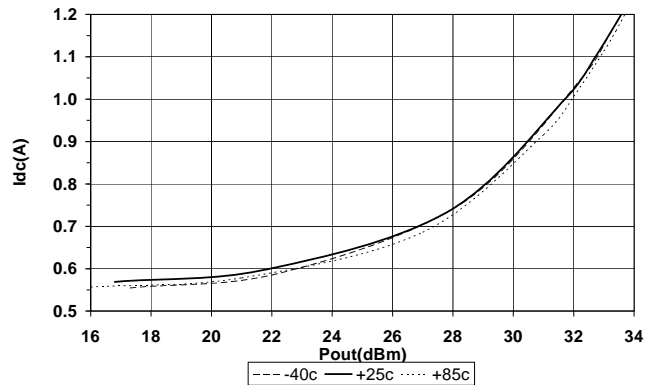

Measured 2.4GHz to 2.5GHz Application Circuit Data ($V_{CC}=V_{PC}=5.0V$, $I_Q=556mA$, $T=25^\circ C$)

RF Power Detector (Vdet) vs Pout, F=2.4GHz

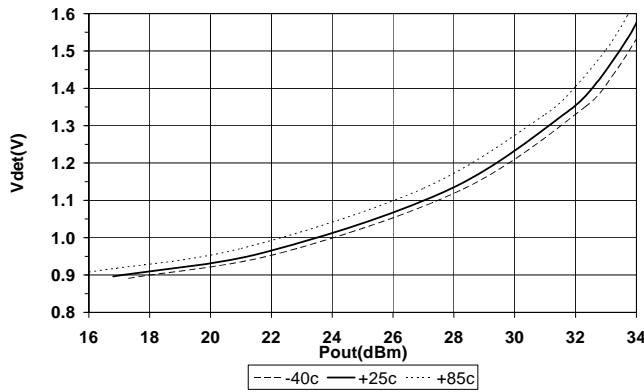

Noise Figure vs Frequency

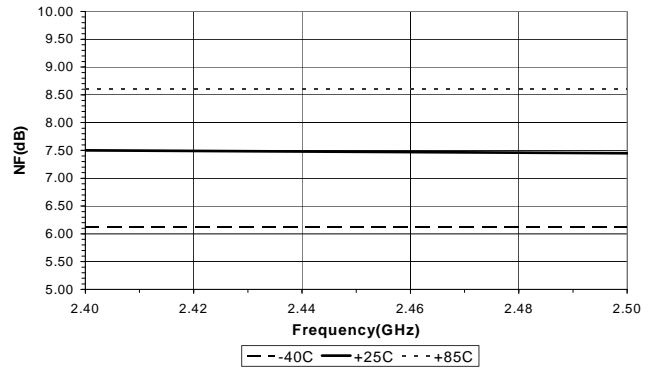

Broadband S11 - Input Return Loss

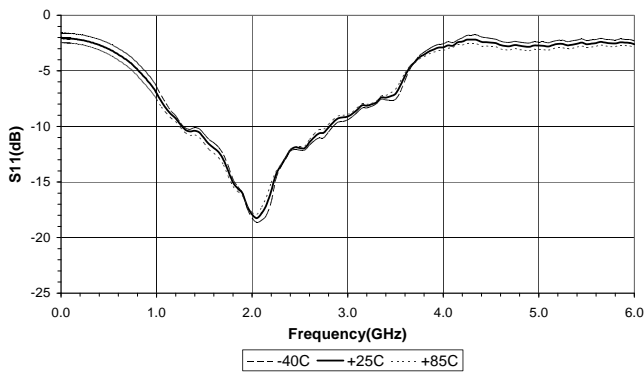

Broadband S21 - Forward Gain

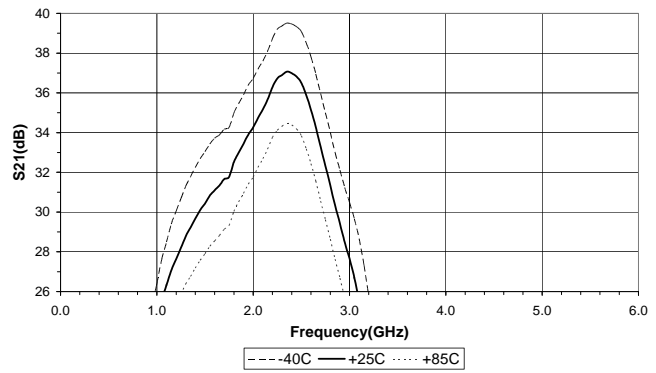

Broadband S22 - Output Return Loss

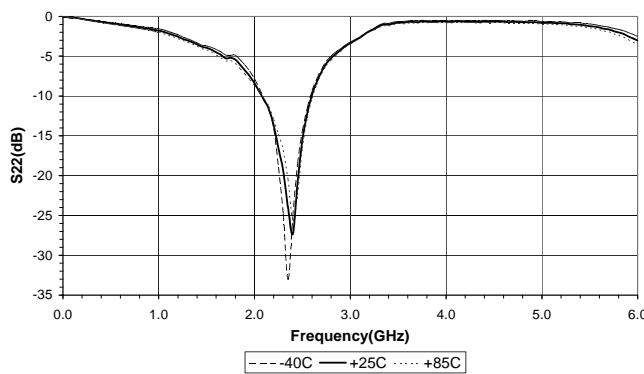

2.4-2.5GHz 20dB Step Attenuator Gain Delta vs Temp. Attenuator Enabled VPC2=0V

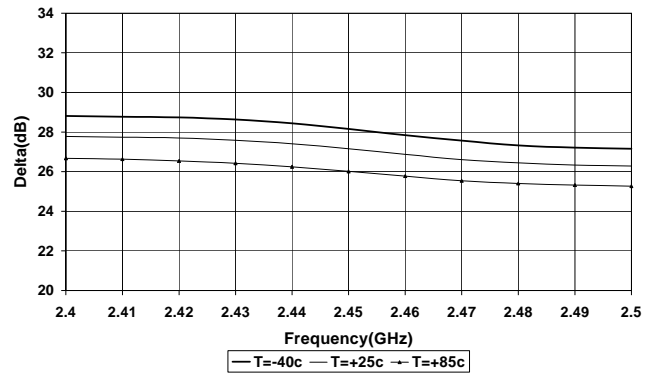

Measured 2.5GHz to 2.7GHz Application Circuit Data ($V_{CC}=V_{PC}=5.0V$, $I_Q=583mA$, $T=25^\circ C$)

EVM vs Pout T=+25c
802.11g, OFDM 54Mb/S, 64QAM

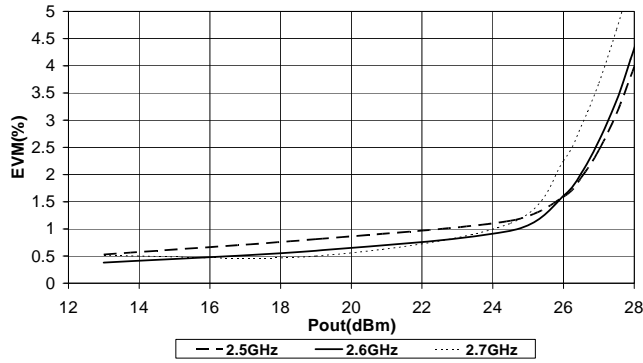

EVM vs Pout F=2.5GHz
802.11g, OFDM 54Mb/S, 64QAM

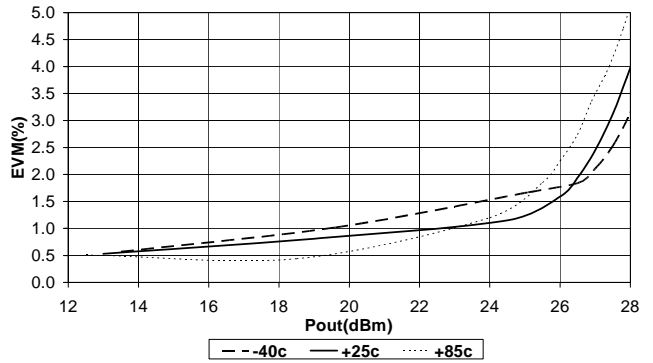

EVM vs Pout F=2.7GHz
802.11g, OFDM 54Mb/S, 64QAM

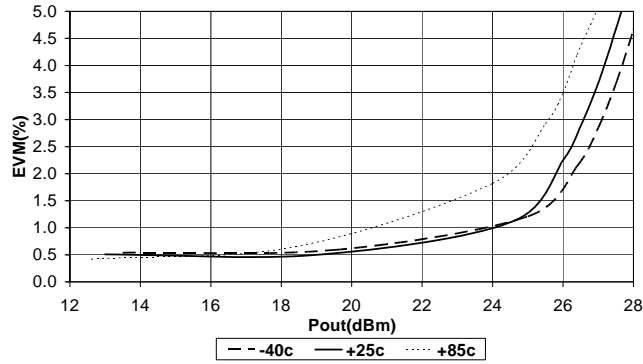

IM3 vs Pout (2 tone avg.), F=2.5GHz

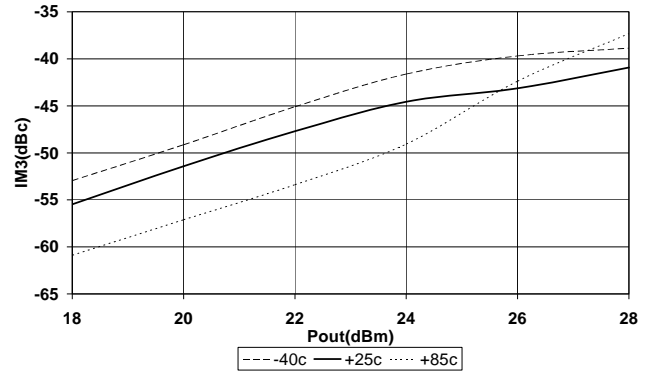

IM3 vs Pout (2 tone avg.), F=2.7GHz

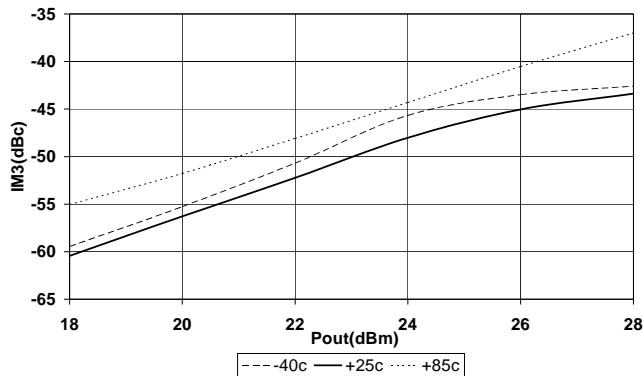

IM3 vs Pout (2 Tone Avg.), T=+25c
Tone Spacing = 1MHz

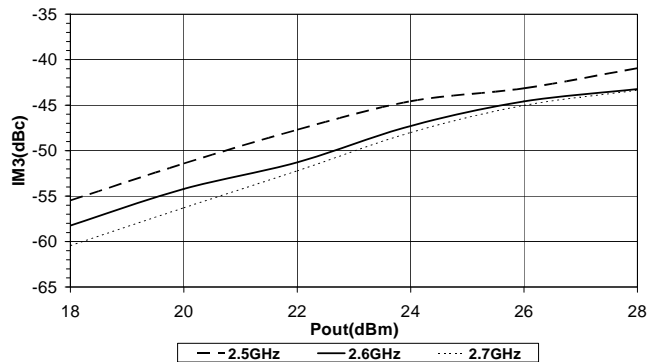

Measured 2.5GHz to 2.7GHz Application Circuit Data ($V_{CC}=V_{PC}=5.0V$, $I_Q=583mA$, $T=25^\circ C$)

Narrowband S11 - Input Return Loss

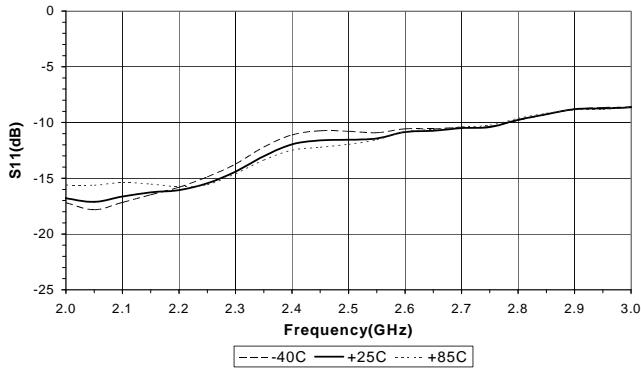

Narrowband S12 - Reverse Isolation

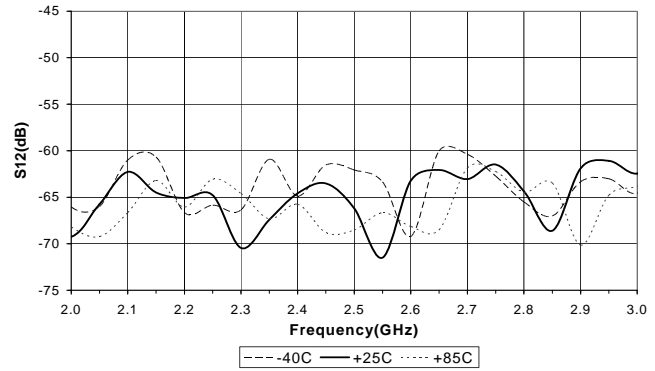

Narrowband S21 - Forward Gain

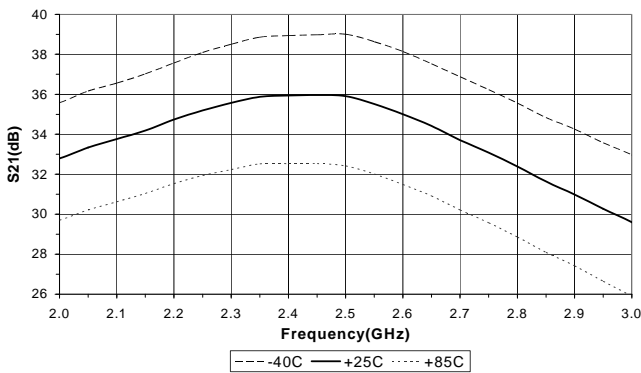

Narrowband S22 - Output Return Loss

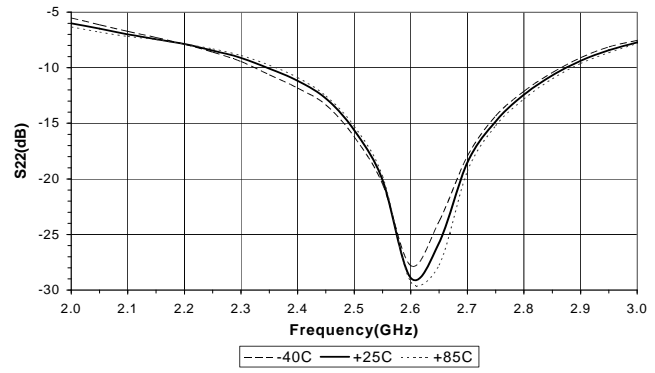

DC Supply Current vs Pout, F=2.5GHz

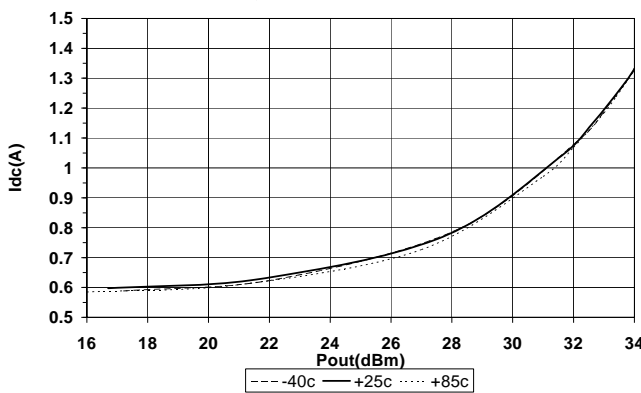

DC Supply Current vs Pout, F=2.7GHz

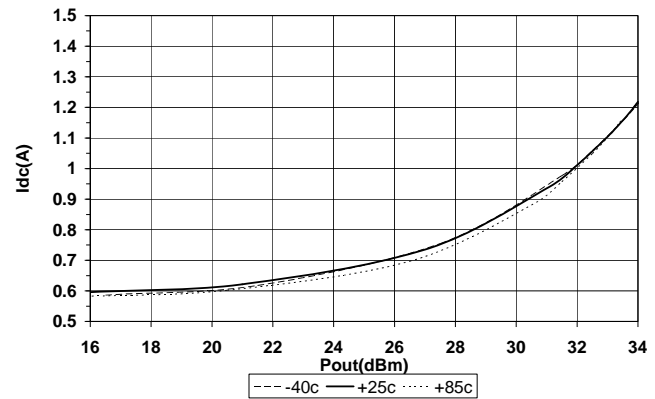

Measured 2.5GHz to 2.7GHz Application Circuit Data ($V_{CC}=V_{PC}=5.0V$, $I_Q=583mA$, $T=25^\circ C$)

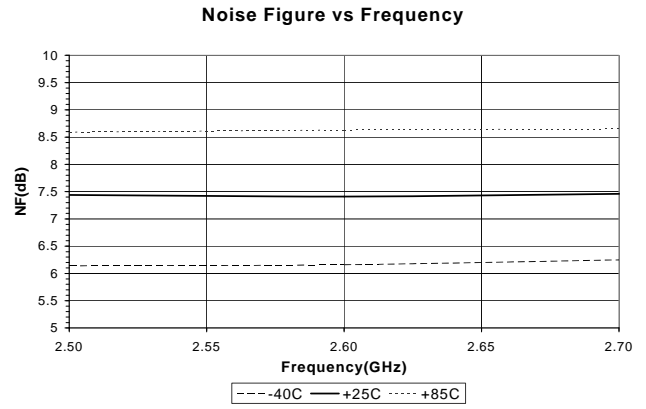
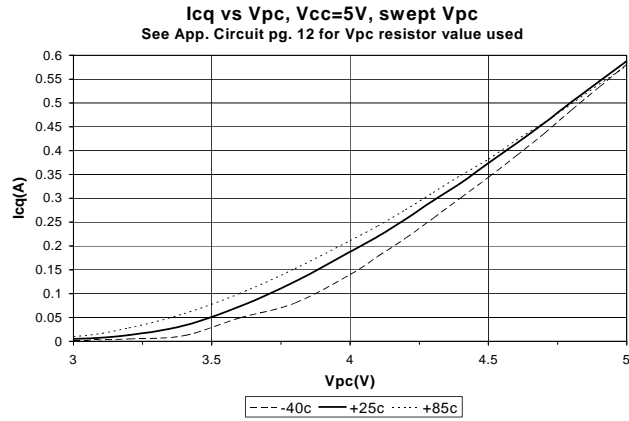
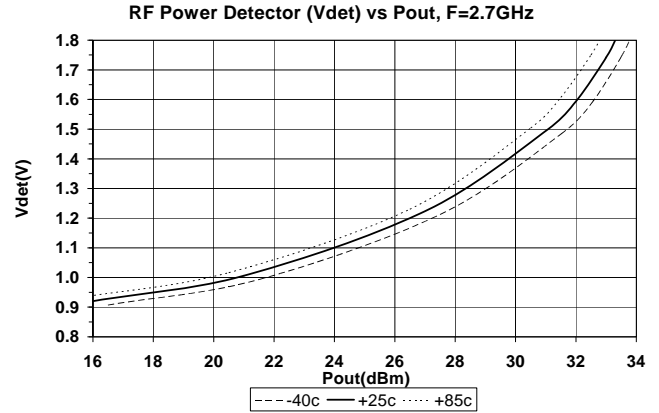
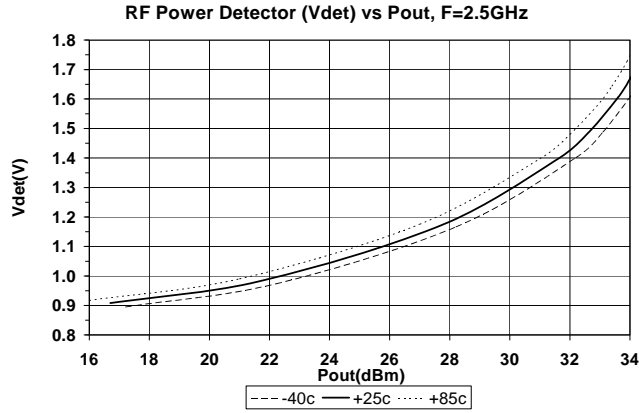

Measured 2.5GHz to 2.7GHz Application Circuit Data ($V_{CC}=V_{PC}=5.0V$, $I_Q=583mA$, $T=25^\circ C$)

Broadband S11 - Input Return Loss

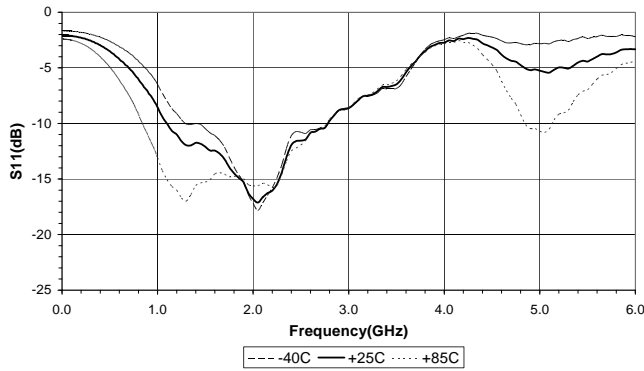

Broadband S21 - Forward Gain

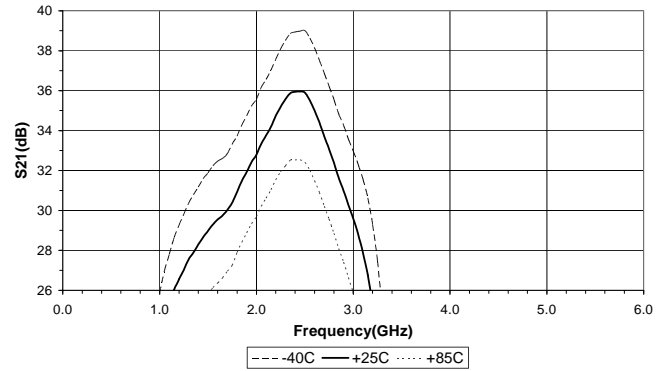

Broadband S22 - Output Return Loss

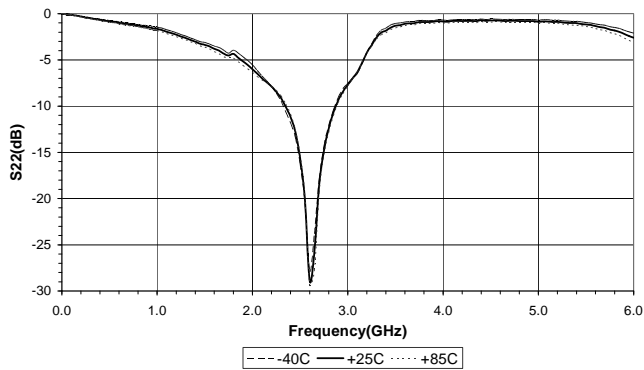

**2.5-2.7GHz 20dB Step Attenuator Gain Delta vs Temp.
Attenuator Enabled VPC2=0V**

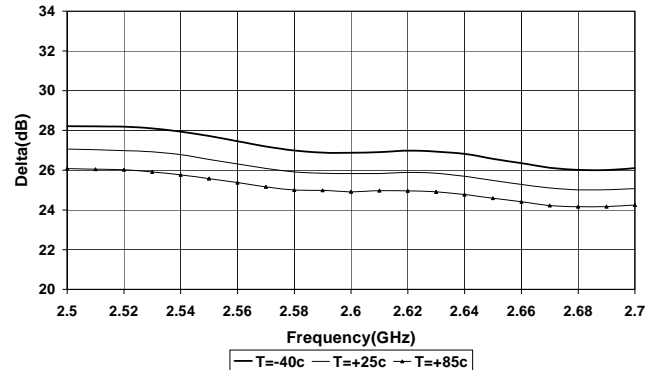

Pin	Function	Description
7, 11, 12, 22, 29, 31, 39, 40	NC	These are no connect (NC) pins and are not wired inside the package. It is recommended to connect them as shown in the application circuit to achieve the stated performance.
1, 10, 21, 30	GND	These pins are internally grounded inside the package to the backside ground paddle. It is recommended to also ground them external to the package to achieve the specified performance.
2	VC1	This is the collector of the first stage.
3	VBIAS12	This is the supply voltage for the active bias circuit of the 1st and 2nd stages.
4-5	R1A-R2A	A resistor is tied across these pins internal to the package.
6	RFIN	This is the RF input pin. It is DC grounded inside the package. Do not apply DC voltage to this pin.
8	VPC1	Power up/down control pin for the 1st stage. An external series resistor is required for proper setting of bias levels depending on control voltage. The voltage on this pin should never exceed the voltage on pin 3 by more than 0.5V unless the supply current from pin 3 is limited < 10mA.
9	VPC2	Power up/down control pin for the 2nd stage. Power down $V_{PC2} < 1V$ for step attenuator function enable. An external series resistor is required for proper setting of bias levels depending on control voltage. The voltage on this pin should never exceed the voltage on pin 3 by more than 0.5V unless the supply current from pin 3 is limited < 10mA.
13, 38	VC2A, VC2B	These two pins are connected internal to the package and connect to the 2nd stage collector. To achieve specified performance, the layout of these pins should match the Recommended Land Pattern.
14-15 17-18 33-34 36-37	C1A-C2A C3A-C4A C4B-C3B C2B-C1B	These pins have capacitors across them internal to the package as shown in the below schematic. They are used as tuning and RF coupling elements between the 2nd and 3rd stage.
16, 35	VB3A, VB3B	These are the connections to the base of the 3rd stage output device. To achieve specified performance, the layout of these pins should match the Recommended Land Pattern.
19	VPC3	Power up/down control pin for the 2nd stage. An external series resistor is required for proper setting of bias levels depending on control voltage. The voltage on this pin should never exceed the voltage on pin 32 by more than 0.5V unless the supply current from pin 33 is limited < 10mA.
20	VDET	This is the output port for the power detector. It samples the power at the input of the 3rd stage.
23-28	RFOUT	These are the RF output pins and DC connections to the 3rd stage collector.
32	VBIAS3	This is the supply voltage for the active bias circuit of the 3rd stage.

Part Symbolization

The part will be symbolized with “SZM-2066Z” to designate it as a RoHS green compliant product. Marking designator will be on the top surface of the package.

Package Drawing

Dimensions in inches (millimeters)

Refer to drawing posted at www.rfmd.com for tolerances.

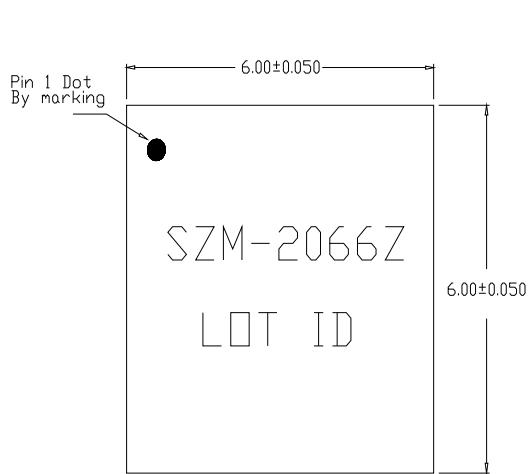

TOP VIEW

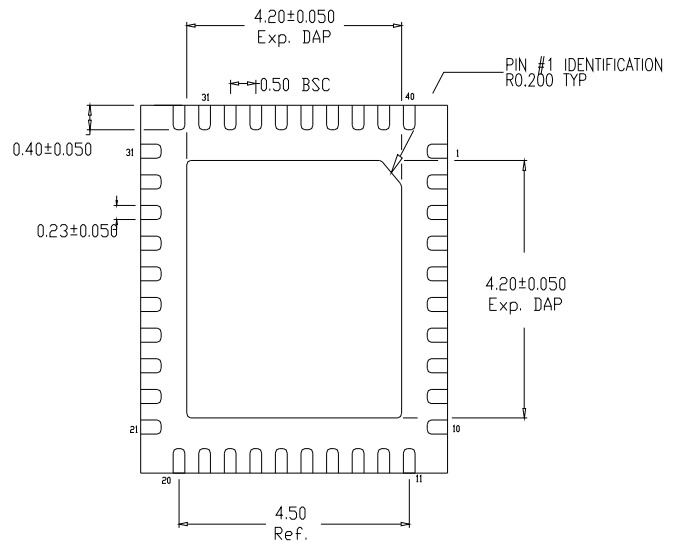

BOTTOM VIEW

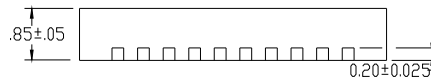

SIDE VIEW

Recommended Metal Land Pattern

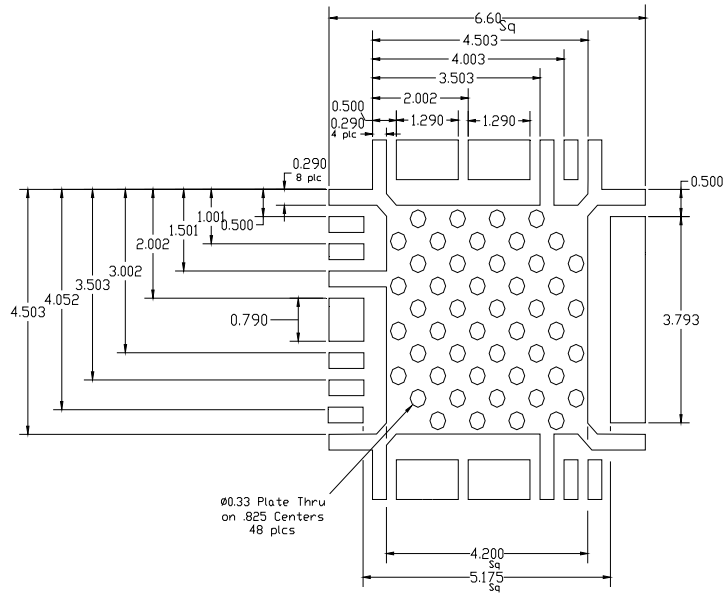

Recommended PCB Soldermask for Land Pattern

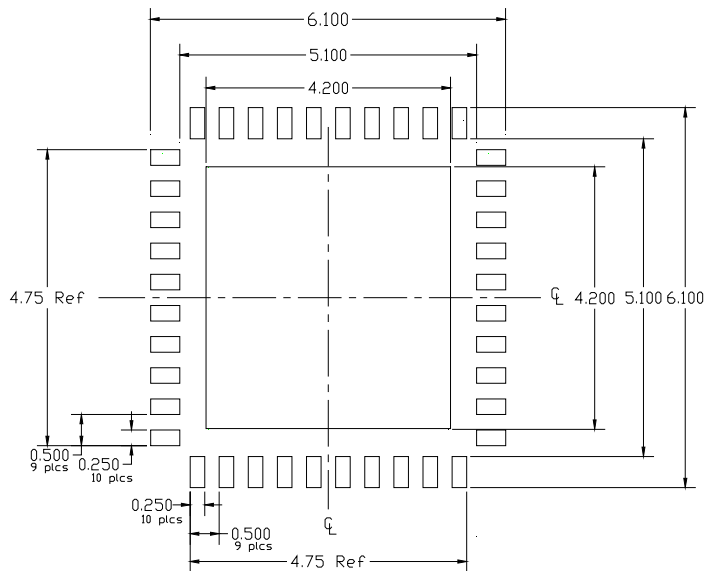

2.4GHz to 2.5GHz Evaluation Board Schematic for $V_{CC}=V+=V_{PC}=5.0V$

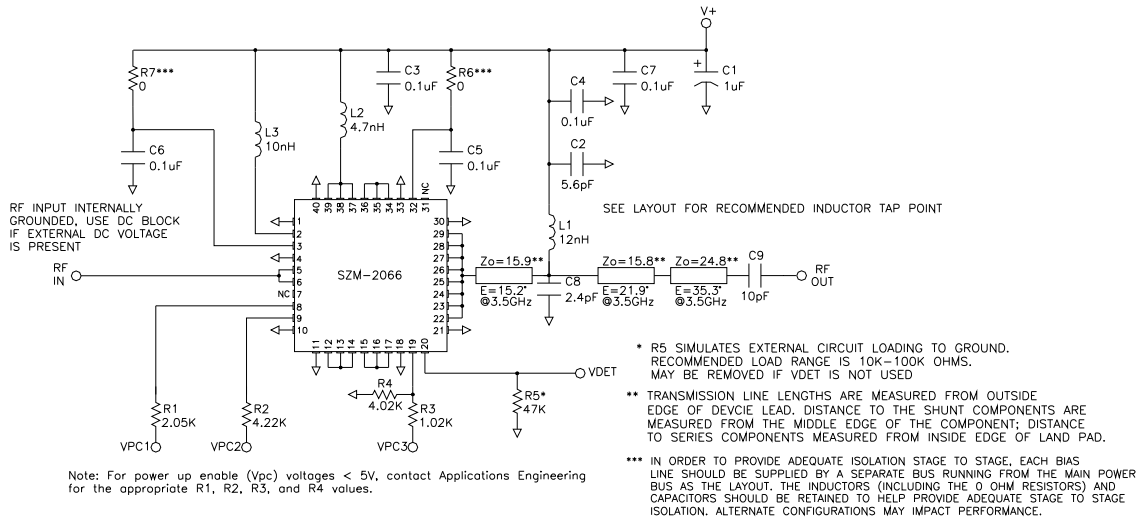

2.4GHz to 2.5GHz Evaluation Board for $V_{CC}=V+=V_{PC}=5.0V$

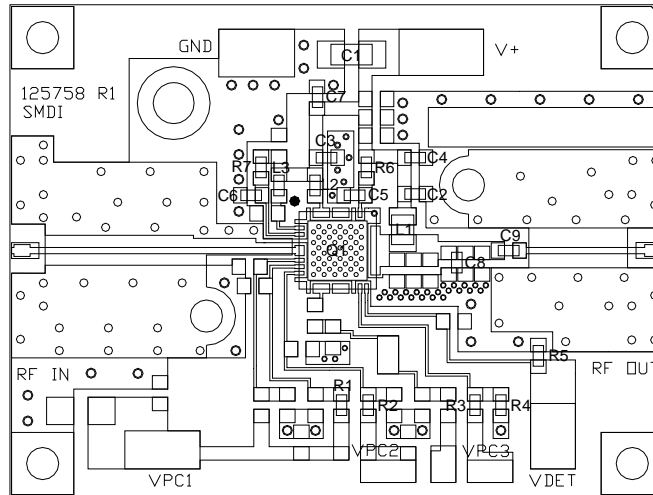

Bill of Materials for the 2.4GHz to 2.5GHz Evaluation Board

Desg	Description	Notes
Q1	SZM-2066Z	6mmx6mm QFN
R1	2.05K Ω , 0603 1%	0402 may be used
R2	4.22K Ω , 0603 1%	0402 may be used
R3	1.02K Ω , 0603 1%	0402 may be used
R4	4.02K Ω , 0603 1%	0402 may be used
R5	47 K Ω , 0603	0402 may be used
R6, 7	0 Ω , 0603	0402 may be used
C1	1 μ F 16V MLCC CAP	Tantalum ok for EVM performance. Use MLCC type for best IM3 levels.
C2	5.6pF CAP, 0603	NPO, ROHM MCH185A5R6DK or equivalent
C3, 4, 5, 6, 7	0.1 μ F CAP, 0603	X7R 0402 ok, ROHM MCH182CN104K or equivalent
C8	2.4pF CAP, 0603	NPO, low ESR, ATC 60052R4CW250 or equivalent
C9	10pF CAP, 0603	X7R 0402 ok, ROHM MCH1182CN104K or equivalent
L1	12nH IND 0805	Coilcraft 0805HQ - 12XJBB
L2	4.7nH IND, 0603	TOKO 0603 - LL1608FH4N7J
L3	10nH IND, 0603	TOKO 0603 - LL1608FH10J

2.5GHz to 2.7GHz Evaluation Board Schematic for $V_{CC}=V+=V_{PC}=5.0V$

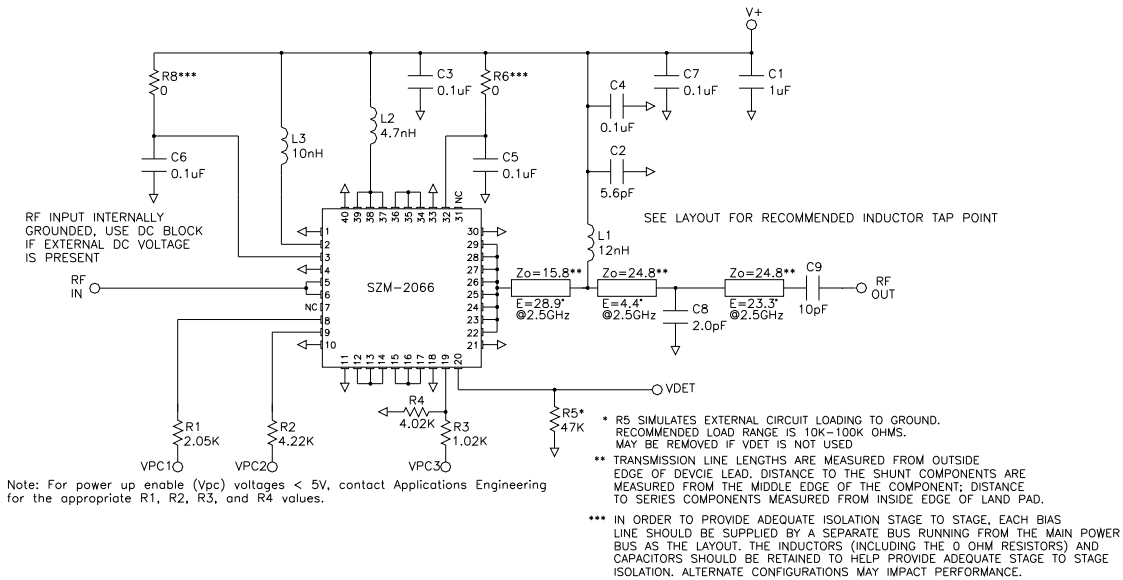

2.5GHz to 2.7GHz Evaluation Board for $V_{CC}=V_{+}=V_{PC}=5.0V$

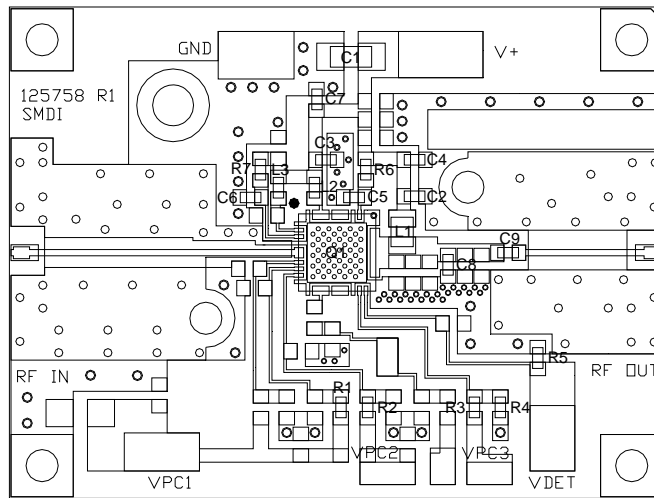

Bill of Materials for the 2.5GHz to 2.7GHz Evaluation Board

Desg	Description	Notes
Q1	SZM-2066Z	6mmx6mm QFN
R1	2.05K Ω , 0603 1%	0402 may be used
R2	4.22K Ω , 0603 1%	0402 may be used
R3	1.02K Ω , 0603 1%	0402 may be used
R4	4.02K Ω , 0603 1%	0402 may be used
R5	47 K Ω , 0603	0402 may be used
R6, 7	0 Ω , 0603	0402 may be used
C1	1 μ F 16V MLCC CAP	Tantalum ok for EVM performance. Use MLCC type for best IM3 levels.
C2	5.6pF CAP, 0603	NPO, ROHM MCH185A5R6DK or equivalent
C3, 4, 5, 6, 7	0.1 μ F CAP, 0603	X7R 0402 ok, ROHM MCH182CN104K or equivalent
C8	2.4pF CAP, 0603	NPO, low ESR, ATC 60052R4CW250 or equivalent
C9	10pF CAP, 0603	NPO, low ESR, ATC 600S100JW250 or equivalent
L1	12nH IND 0805	Coilcraft 0805HQ - 12XJBB
L2	4.7nH IND, 0603	TOKO 0603 - LL1608FH4N7J
L3	10nH IND, 0603	TOKO 0603 - LL1608FH10J

Ordering Information

Ordering Code	Description
SZM2066ZSQ	Standard 25 piece bag
SZM2066ZSR	Standard 100 piece reel
SZM2066Z	Standard 1000 piece reel
SZM2066ZPCK-EVB2	Evaluation Board 2.4GHz to 2.5GHz Tune and 5 loose sample pieces
SZM2066ZPCK-EVB3	Evaluation Board 2.5GHz to 2.7 GHz Tune and 5 loose sample pieces