

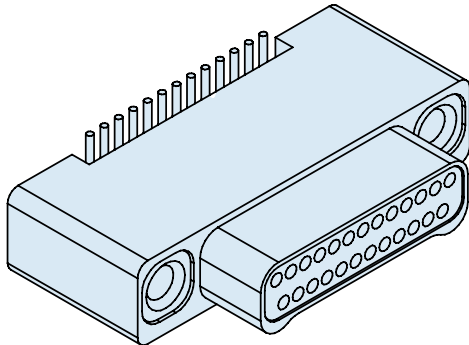

891-010 and 891-011 Right Angle Mount PCB, Dual Row Nano Connector Surface Mount Type



Vertical Surface Mount PCB Nano Connectors feature gold alloy TwistPin contacts. Contacts are precision-crimped #30 AWG gold-plated wire. These nanominiature connectors offer premium performance and reliability for demanding applications.

Pre-Tinned PC Tails are coated with Sn63Pb37 tin-lead for excellent solderability.

Choose Aluminum, Titanium or Stainless Steel Shells in ten layouts from 9 to 85 contacts. Complies to the requirements of MIL-DTL-32139.

How to Order Vertical Mount SMT Connectors

Sample Part Number	891-011	-51S	A2	-BSS	T
Series	891-010 Plug, Pin Contacts, Dual Row, Vertical SMT Nanominiature 891-011 Receptacle, Socket Contacts, Dual Row, Vertical SMT Nanominiature				
Insert Arrangement/ Contact Type	Plugs (891-010): 9P, 15P, 21P, 25P, 31P, 37P, 51P, 65P, 69P, 85P Receptacles (891-011): 9S, 15S, 21S, 25S, 31S, 37S, 51S, 65S, 69S, 85S				
Shell Material and Finish	A1 - Aluminum Shell, Cadmium Plating T - Titanium Shell, Unplated A2 - Aluminum Shell, Electroless Nickel Plating S - Stainless Steel Shell, Passivated				
Termination Type	BSS - Board Surface Mount Straight™				
Hardware	T - Female Thread				

Dimensions in inches (millimeters) and are subject to change without notice.

891-010 and 891-011 Right Angle Mount PCB, Dual Row Nano Connector Surface Mount Type



Dual Row Vertical Surface Mount Nano Dimensions

891-010 Plug (Pin) Connectors

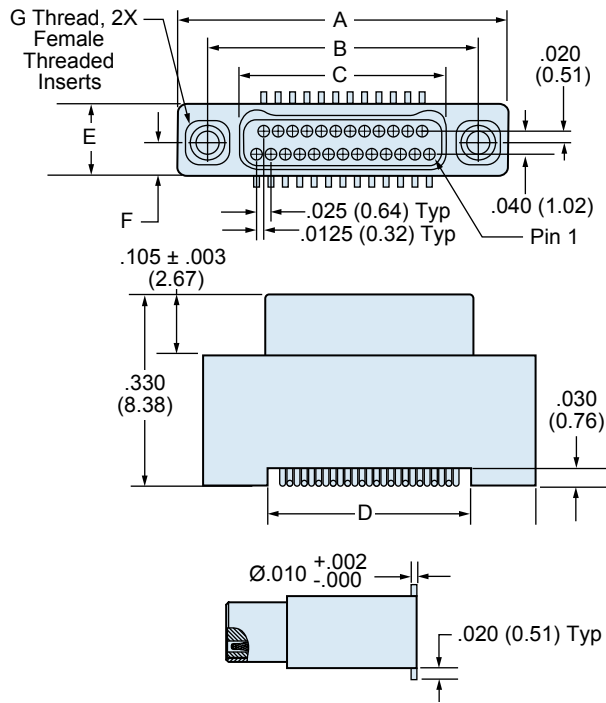

891-011 Receptacle (Socket) Connectors

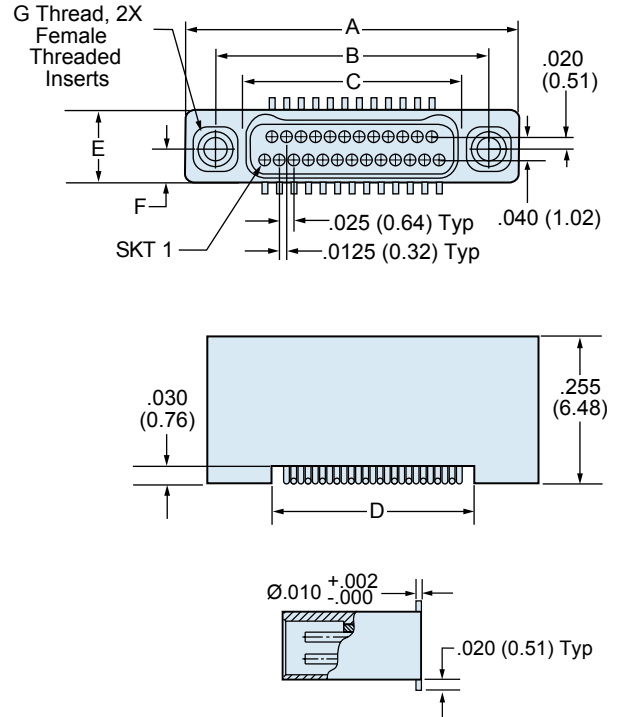

Layout	A		B BSC.		C BSC.		D		E		F BSC.		G Thread
	In. ± .005	mm. ± 0.13	In.	mm.	In.	mm.	In. ± .005	mm. ± 0.13	In. ± .005	mm ± 0.13	In.	mm	
9P	.375	9.52	.270	6.86	.160	4.06	.152	3.86	.125	3.18	.0575	1.46	#0-80 UNF
9S	.375	9.52	.270	6.86	.163	4.14	.152	3.86	.125	3.18	.0575	1.46	#0-80 UNF
15P	.450	11.43	.345	8.76	.235	5.97	.227	5.77	.125	3.18	.0575	1.46	#0-80 UNF
15S	.450	11.43	.345	8.76	.238	6.04	.227	5.77	.125	3.18	.0575	1.46	#0-80 UNF
21P	.525	13.33	.420	10.67	.310	7.87	.302	7.67	.125	3.18	.0575	1.46	#0-80 UNF
21S	.525	13.33	.420	10.67	.313	7.95	.302	7.67	.125	3.18	.0575	1.46	#0-80 UNF
25P	.575	14.60	.470	11.94	.360	9.14	.352	8.94	.125	3.18	.0575	1.46	#0-80 UNF
25S	.575	14.60	.470	11.94	.363	9.22	.352	8.94	.125	3.18	.0575	1.46	#0-80 UNF
31P	.650	16.51	.545	13.84	.435	11.05	.427	10.85	.125	3.18	.0575	1.46	#0-80 UNF
31S	.650	16.51	.545	13.84	.438	11.12	.427	10.85	.125	3.18	.0575	1.46	#0-80 UNF
37P	.725	18.41	.620	15.75	.510	12.95	.502	12.75	.125	3.18	.0575	1.46	#0-80 UNF
37S	.725	18.41	.620	15.75	.513	13.03	.502	12.75	.125	3.18	.0575	1.46	#0-80 UNF
51P	.900	22.86	.795	20.19	.685	17.40	.677	17.20	.125	3.18	.0575	1.46	#0-80 UNF
51S	.900	22.86	.795	20.19	.688	17.47	.677	17.20	.125	3.18	.0575	1.46	#0-80 UNF
65P	1.075	27.30	.970	24.64	.860	21.84	.852	21.64	.125	3.18	.0575	1.46	#0-80 UNF
65S	1.075	27.30	.970	24.64	.863	21.92	.852	21.64	.125	3.18	.0575	1.46	#0-80 UNF
69P	1.125	28.57	1.020	25.91	.910	23.11	.902	22.91	.125	3.18	.0575	1.46	#0-80 UNF
69S	1.125	28.57	1.020	25.91	.913	23.19	.902	22.91	.125	3.18	.0575	1.46	#0-80 UNF
85P	1.377	34.97	1.246	31.65	1.110	28.19	1.102	27.99	.150	3.81	.070	1.78	#2-56 UNC
85S	1.377	34.97	1.246	31.65	1.113	28.27	1.102	27.99	.150	3.81	.070	1.78	#2-56 UNC

Dual Row Vertical Surface Mount Board Layout — 891-010 Plugs (Pin) Connectors

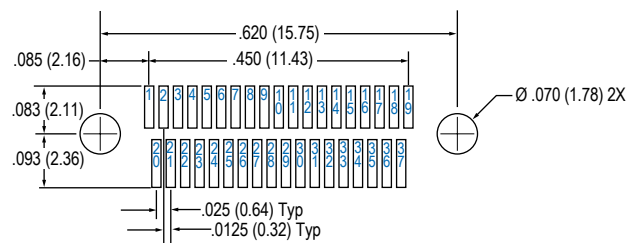
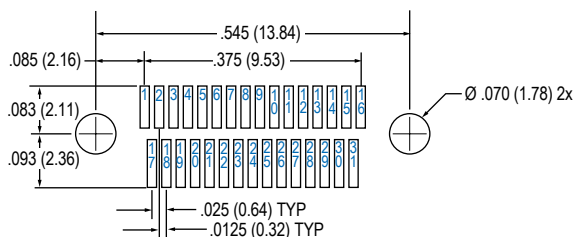
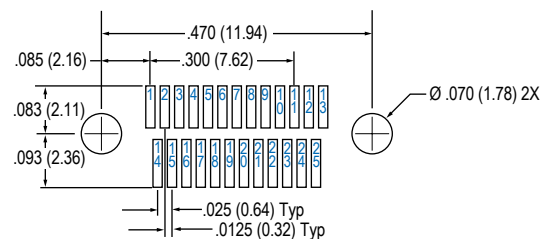
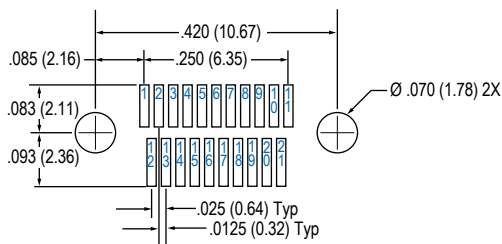
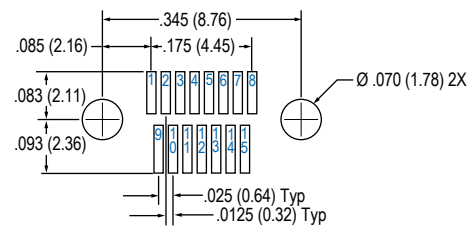
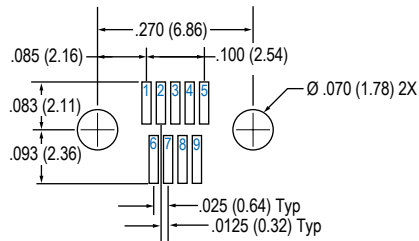
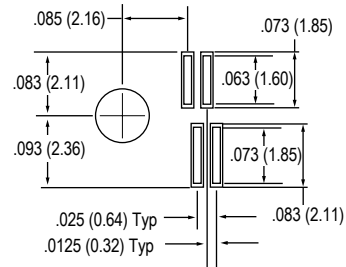

31 Contacts

37 Contacts

Layouts shown are for connector mounting side of PC Board.

891-010 and 891-011 Right Angle Mount PCB, Dual Row Nano Connector Surface Mount Type



Dual Row
Connectors

Dual Row Vertical Surface Mount Board Layout — 891-010 Plugs (Pin) Connectors

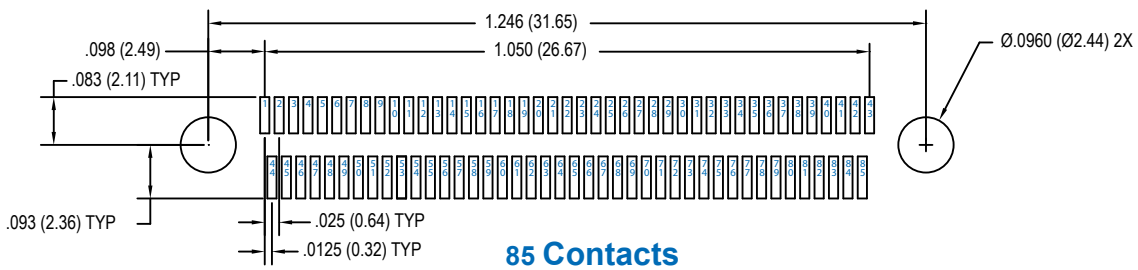
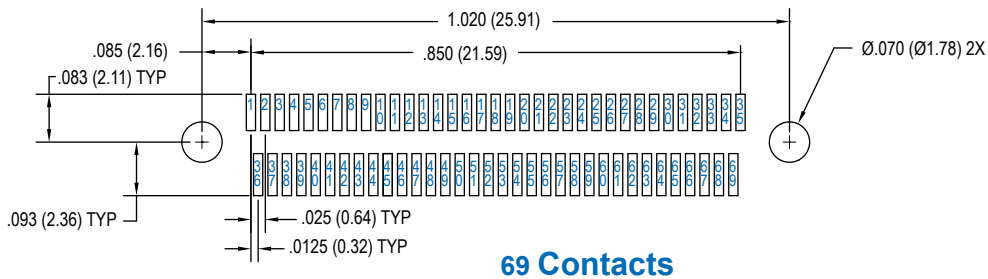
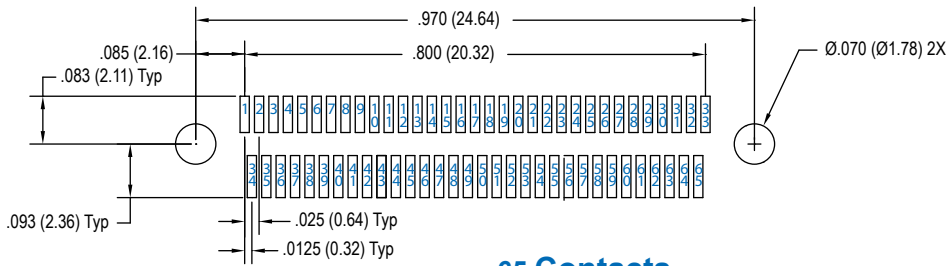
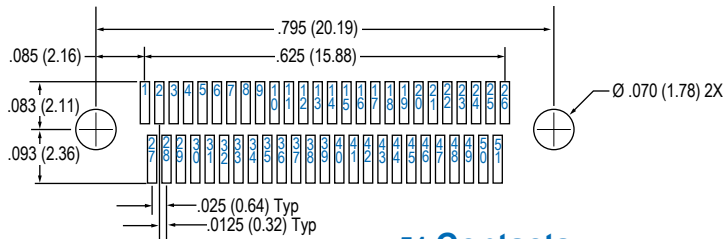
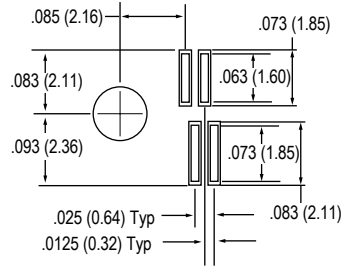

Layouts shown are for connector mounting side of PC Board.



Dual Row Vertical Surface Mount Board Layout — 891-011 Receptacle (Socket) Connectors

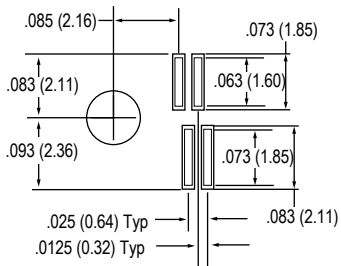

PAD/ FOOTPRINT DETAIL

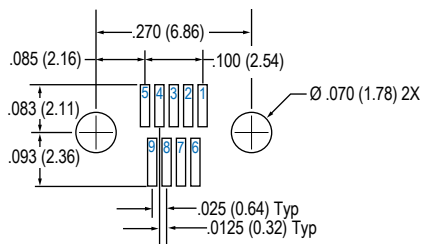

9 Contacts

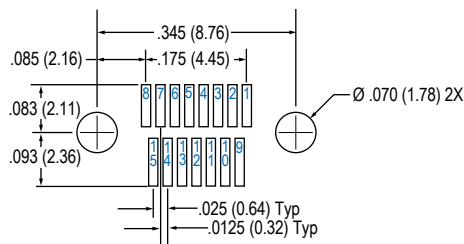

15 Contacts

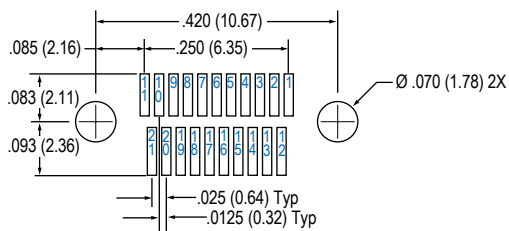

21 Contacts

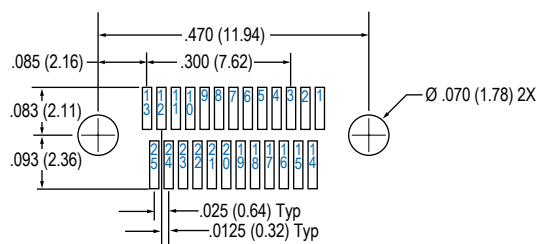

25 Contacts

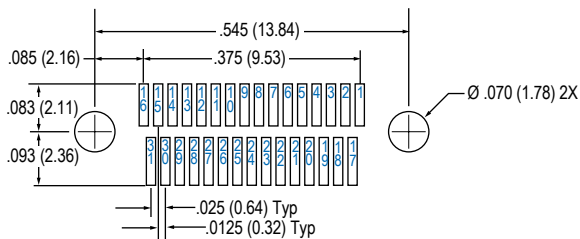

31 Contacts

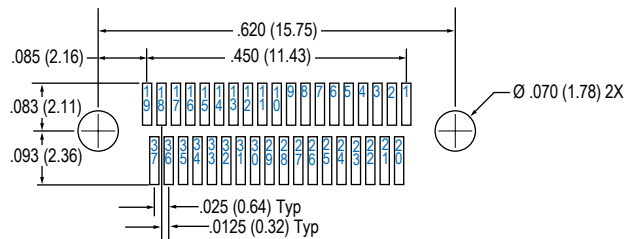

37 Contacts

Layouts shown are for connector mounting side of PC Board.

891-010 and 891-011 Right Angle Mount PCB, Dual Row Nano Connector Surface Mount Type



Dual Row Vertical Surface Mount Board Layout—891-011 Receptacle (Socket) Connectors

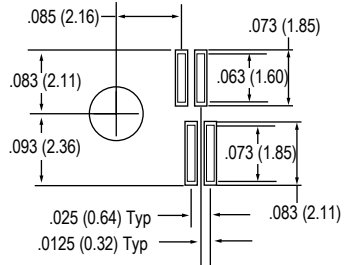

PAD/ FOOTPRINT DETAIL

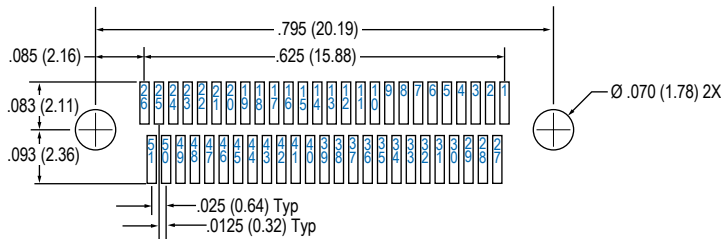

51 Contacts

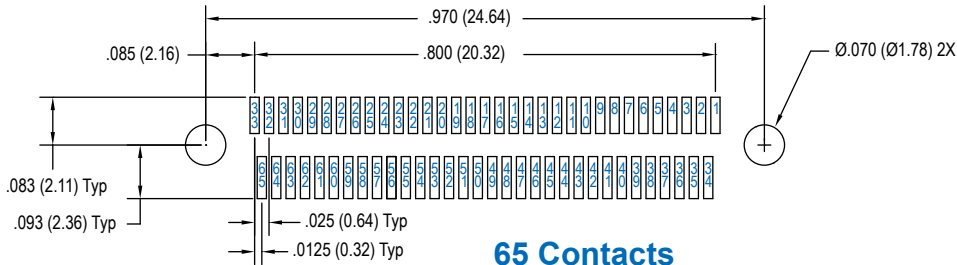

65 Contacts

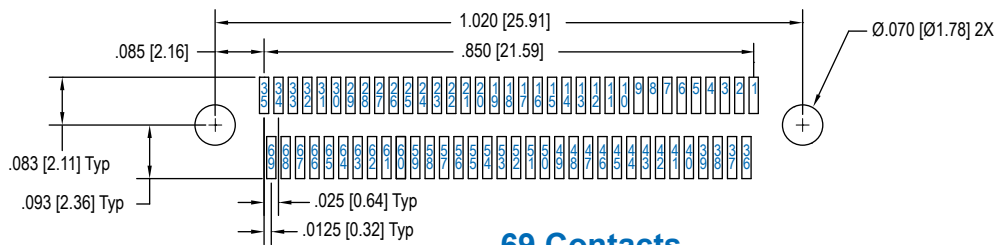

69 Contacts

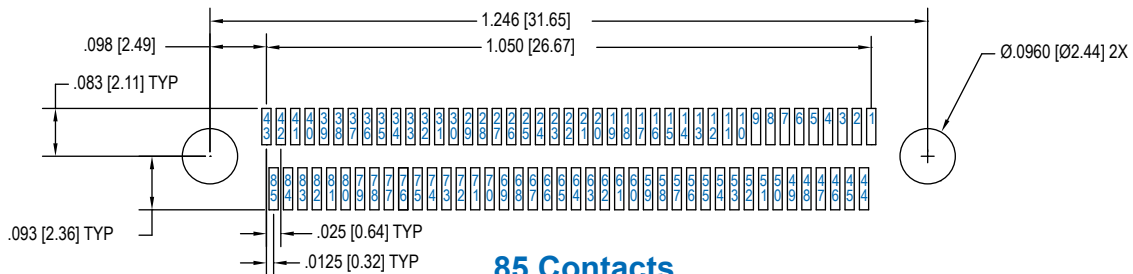

85 Contacts

Layouts shown are for connector mounting side of PC Board.