

Features

- 0402 and 0603 package options
- Rated for IEC 61000-4-2, for applications requiring up to 18 V DC
- Withstands multiple ESD strikes
- Low capacitance and leakage currents for invisible load protection
- Tape and reel packaging

ChipGuard® MLE Series Varistor ESD Clamp Protectors

Description

The ChipGuard® CG0402MLE and CG0603MLE Series have been designed to provide high frequency attenuation, thereby providing suppression and filtering in a single device. The MLE family also offers protection to ESD standards such as IEC61000-4-2 for applications requiring up to 18 V DC and is available in the industry standard 0603 and 0402 type leadless surface mount packaging.

Electrical Characteristics @ 25 °C (unless otherwise noted)

Model	Continuous Operating Voltage			Clamping Voltage	Off-state Current					Capacitance
	V_{rms} (V)	V_{DC} (V)		V_{CLAMP} (V)	I_L (μA)					C_p (pF)
	Max.	Typ.	Max.	Typ.	Max.					Max.
				1 A @ 8/20 μs	3.5 V	5.5 V	9 V	12 V	18 V	1 Vrms @ 1 MHz
CG0402MLE-18G	8.5	12	18	100	0.3	0.4	0.5	1	10	9
CG0603MLE-18E	8.5	12	18	60	0.3	0.4	0.5	1	10	50

Environmental Characteristics

Operating Temperature ...-55 °C to +125 °C
 Storage Temperature.....-55 °C to +125 °C
 Response Time.....<1 ns
 Standard..... IEC 61000-4-2 Level 4

These products are RoHS compliant. There is some lead contained within the glass of the ceramic. This is acceptable under exemption no. 5 of the RoHS directive (DIRECTIVE 2002/95/EC OF THE EUROPEAN PARLIAMENT AND OF THE COUNCIL of 27 January 2003 on the restriction of the use of certain hazardous substances in electrical and electronic equipment).

Schematic

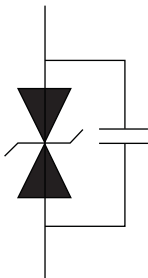

Surge Withstand Ratings

Model	Peak Current 8/20 μs (Max.)	Peak Current @ 8 kV (Max.)
CG0402MLE-18G	15 A	30 A
CG0603MLE-18E	20 A	45 A

Voltage-Current Characteristics

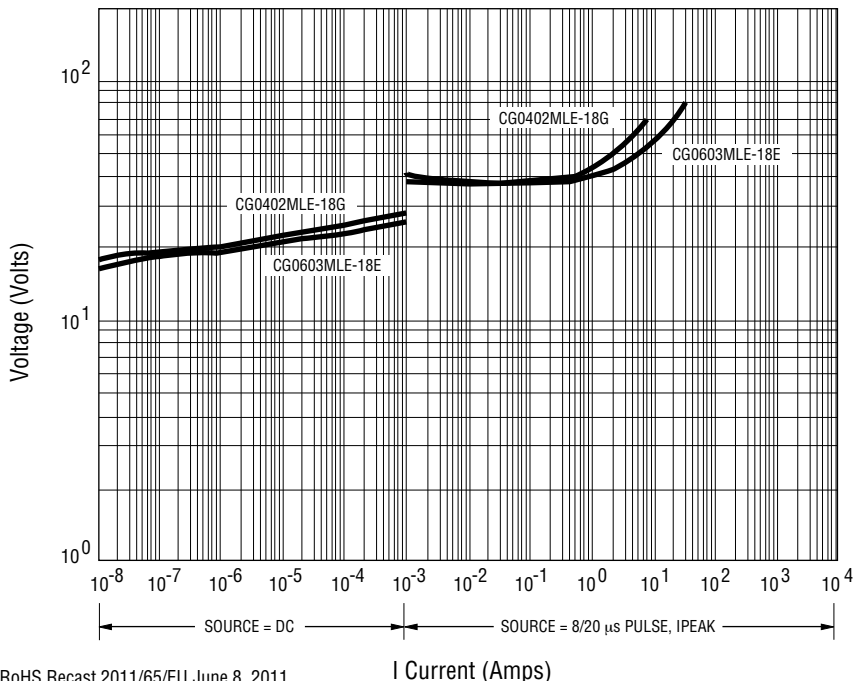

*RoHS Directive 2002/95/EC Jan. 27, 2003 including annex and RoHS Recast 2011/65/EU June 8, 2011. Specifications are subject to change without notice. Customers should verify actual device performance in their specific applications.

I Current (Amps)

ChipGuard® MLE Series Varistor ESD Clamp Protectors



Product Dimensions

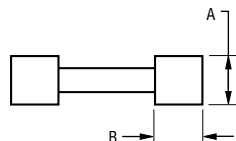
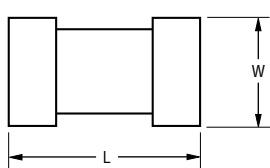

DIMENSIONS: $\frac{\text{MM}}{\text{(INCHES)}}$

Recommended Pad Layout

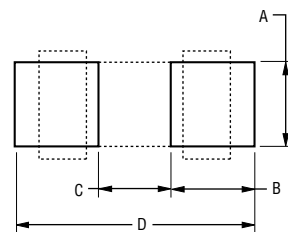

Dimension	CG0402MLE Series	CG0603MLE Series
L	1.00 ± 0.15 (0.04 ± 0.006)	1.60 ± 0.20 (0.064 ± 0.008)
W	0.50 ± 0.10 (0.02 ± 0.004)	0.80 ± 0.20 (0.032 ± 0.008)
A	0.50 ± 0.10 (0.02 ± 0.004)	0.80 ± 0.20 (0.032 ± 0.008)
B	0.25 ± 0.15 (0.10 ± 0.006)	0.30 ± 0.20 (0.012 ± 0.008)

Dim.	CG0402MLE Series	CG0603MLE Series
A	0.51 (0.020)	0.76 (0.030)
B	0.61 (0.024)	1.02 (0.040)
C	0.51 (0.020)	0.50 (0.020)
D	1.70 (0.067)	2.54 (0.100)

Solder Reflow Recommendations

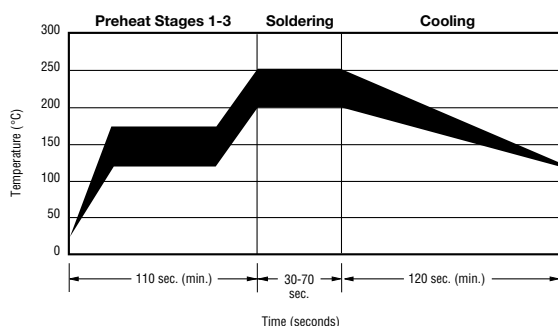

A	Stage 1 Preheat	Ambient to Preheating Temperature	30 s to 60 s
B	Stage 2 Preheat	140 °C to 160 °C	60 s to 120 s
C	Stage 3 Preheat	Preheat to 200 °C	20 s to 40 s
D	Main Heating	200 °C 210 °C 220 °C 230 °C 240 °C	60 s to 70 s 55 s to 65 s 50 s to 60 s 40 s to 50 s 30 s to 40 s
E	Cooling	200 °C to 100 °C	1 °C/s to 4 °C/s

- This product can be damaged by rapid heating, cooling or localized heating.
- Heat shocks should be avoided. Preheating and gradual cooling recommended.
- Excessive solder can damage the device. Print solder thickness of 150 to 200 um recommended.
- Solder gun tip temperature should be kept below 280 °C and should not touch the device directly. Contact should be less than 3 seconds. A solder gun under 30 watts is recommended.

How to Order

CG 0n0n MLE - 18 x

ChipGuard® Product Designator _____

Package Option _____

0402 = 0402 Package 0603 = 0603 Package

Multilayer Series Designator _____

Operating Voltage _____

18 = 18 V

Tape & Reel Packaging _____

E = 4,000 pcs. per reel (0603 package) G = 10,000 pcs. per reel (0402 package)

Ni barrier terminations are standard on all ChipGuard® part numbers.

ChipGuard® MLE Series Varistor ESD Clamp Protectors

BOURNS®

Packaging Dimensions

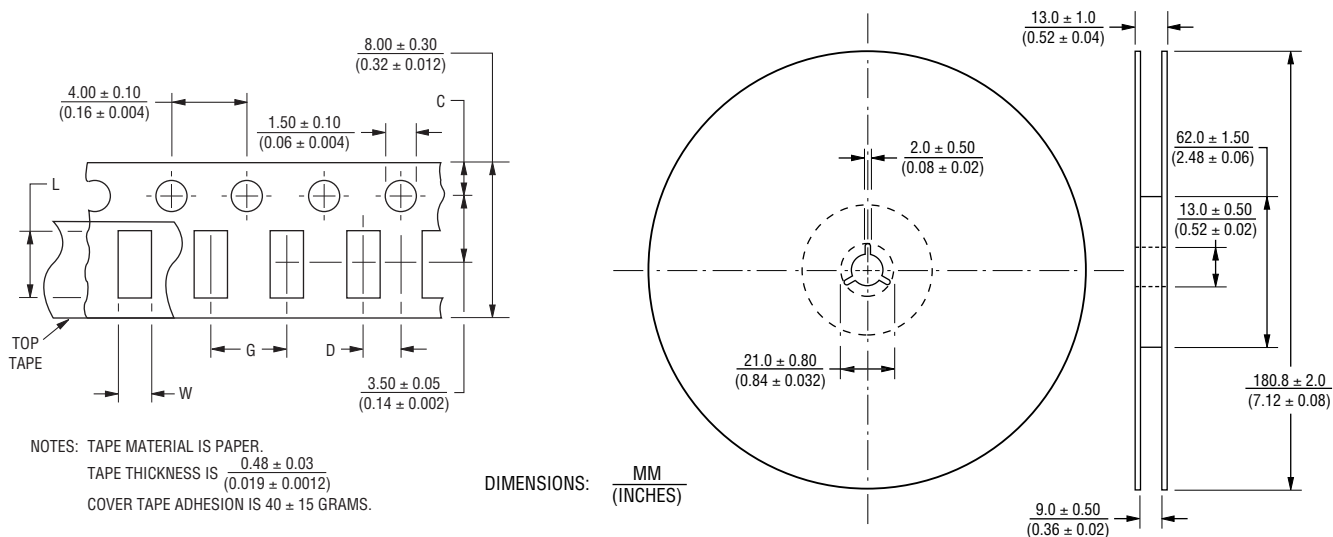

Dimension	CG0402MLE Series	CG0603MLE Series
C	$\frac{1.75 \pm 0.05}{(0.04 \pm 0.002)}$	$\frac{1.75 \pm 0.10}{(0.04 \pm 0.004)}$
D	$\frac{2.00 \pm 0.02}{(0.08 \pm 0.0008)}$	$\frac{2.00 \pm 0.05}{(0.08 \pm 0.002)}$
L	$\frac{1.19 \pm 0.05}{(0.047 \pm 0.002)}$	$\frac{1.80 \pm 0.20}{(0.072 \pm 0.008)}$
W	$\frac{0.69 \pm 0.05}{(0.027 \pm 0.002)}$	$\frac{0.90 \pm 0.20}{(0.036 \pm 0.008)}$
G	$\frac{2.0 \pm 0.05}{(0.08 \pm 0.002)}$	$\frac{4.0 \pm 0.05}{(0.16 \pm 0.002)}$

BOURNS®

Asia-Pacific: Tel: +886-2 2562-4117 • Fax: +886-2 2562-4116

Europe: Tel: +41-41 768 5555 • Fax: +41-41 768 5510

The Americas: Tel: +1-951 781-5500 • Fax: +1-951 781-5700

www.bourns.com

REV. I 09/12

Specifications are subject to change without notice.
Customers should verify actual device performance in their specific applications.