

\*RoHS COMPLIANT

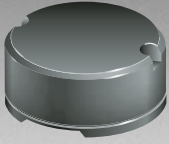

**BOURNS®**

### Features

- Available in E12 series
- Height of 2.9 mm
- Current rating up to 2.1 A
- RoHS compliant\*

### Applications

- Input/output of DC/DC converters
- Power supplies for:
  - Portable communication equipment
  - Camcorders
  - LCD TVs
  - Car radios

## SRR0905 Series - Shielded SMD Power Inductors

### Electrical Specifications

Bourns Part No.	Inductance 100 kHz		Q Ref.	Test Frequency (MHz)	SRF Typ. (MHz)	DCR Max. (Ω)	Idc (A)
	(μH)	Tol. %					
SRR0905-100M	10	±20	39	2.52	29	0.06	2.1
SRR0905-120M	12	±20	40	2.52	26	0.07	1.9
SRR0905-150M	15	±20	35	2.52	24	0.07	1.7
SRR0905-180M	18	±20	39	2.52	21	0.08	1.6
SRR0905-220M	22	±20	35	2.52	18	0.08	1.4
SRR0905-270M	27	±20	35	2.52	17	0.10	1.3
SRR0905-330Y	33	±15	27	2.52	14	0.11	1.2
SRR0905-390Y	39	±15	31	2.52	14	0.12	1.1
SRR0905-470Y	47	±15	27	2.52	11	0.14	1.0
SRR0905-560Y	56	±15	26	2.52	11	0.19	0.93
SRR0905-680Y	68	±15	26	2.52	10	0.21	0.85
SRR0905-820Y	82	±15	26	2.52	9	0.28	0.79
SRR0905-101K	100	±10	29	0.796	8	0.34	0.72
SRR0905-121K	120	±10	31	0.796	7	0.37	0.63
SRR0905-151K	150	±10	24	0.796	6	0.51	0.55
SRR0905-181K	180	±10	24	0.796	5	0.57	0.50
SRR0905-221K	220	±10	27	0.796	5	0.78	0.47
SRR0905-271K	270	±10	30	0.796	5	0.87	0.41
SRR0905-331K	330	±10	29	0.796	4	1.20	0.37
SRR0905-391K	390	±10	26	0.796	3	1.34	0.35
SRR0905-471K	470	±10	26	0.796	3	1.50	0.33

### General Specifications

Test Voltage ..... 1 Volt  
 Reflow Soldering ..... 230 °C; 50 sec max.  
 Operating Temperature .. -40 °C to +125 °C  
 (Temperature rise included)  
 Storage Temperature .. -40 °C to +125 °C  
 Resistance to Soldering Heat  
 ..... 260 °C for 5 sec.

### Materials

Core Material ..... Ferrite DR & RI  
 Wire ..... Enamelled Copper  
 Terminal ..... Ag/Ni/Sn  
 Rated Current ... Ind. drop 10 % typ at I sat  
 Temperature Rise .. 15 °C typ. at rated I rms  
 Packaging ..... 800 pcs. per reel

### Product Dimensions

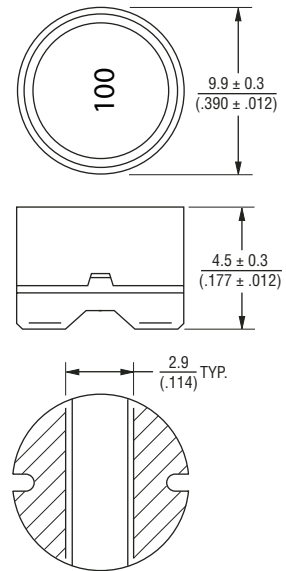

### Recommended Layout

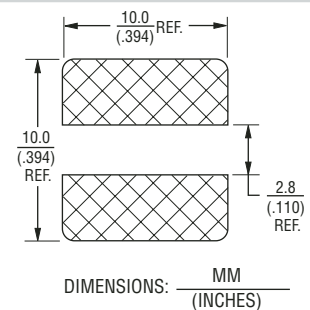

### Inductance vs. Current

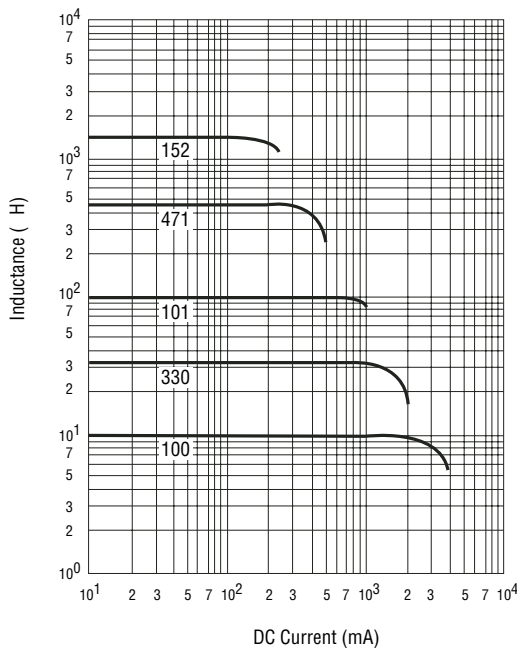

\*RoHS Directive 2002/95/EC Jan 27 2003 including Annex  
 Specifications are subject to change without notice.  
 Customers should verify actual device performance in their specific applications.

# SRR0905 Series - Shielded SMD Power Inductors

**BOURNS®**

## Soldering Profile

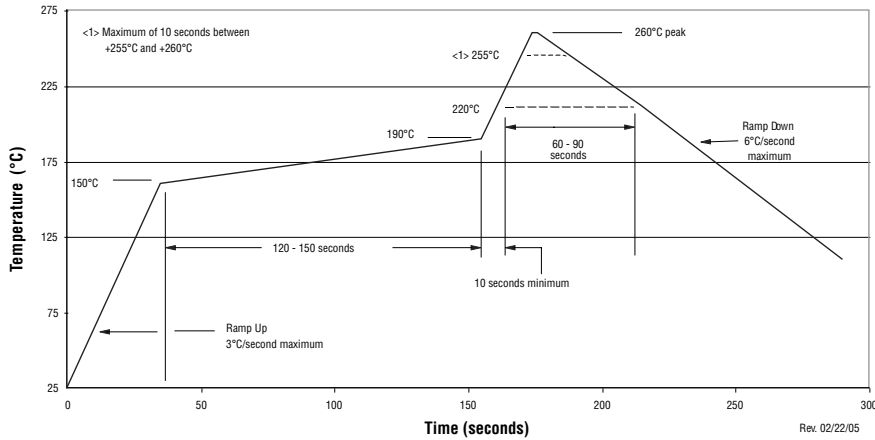

## Electrical Schematic

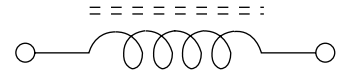

## Packaging Specifications

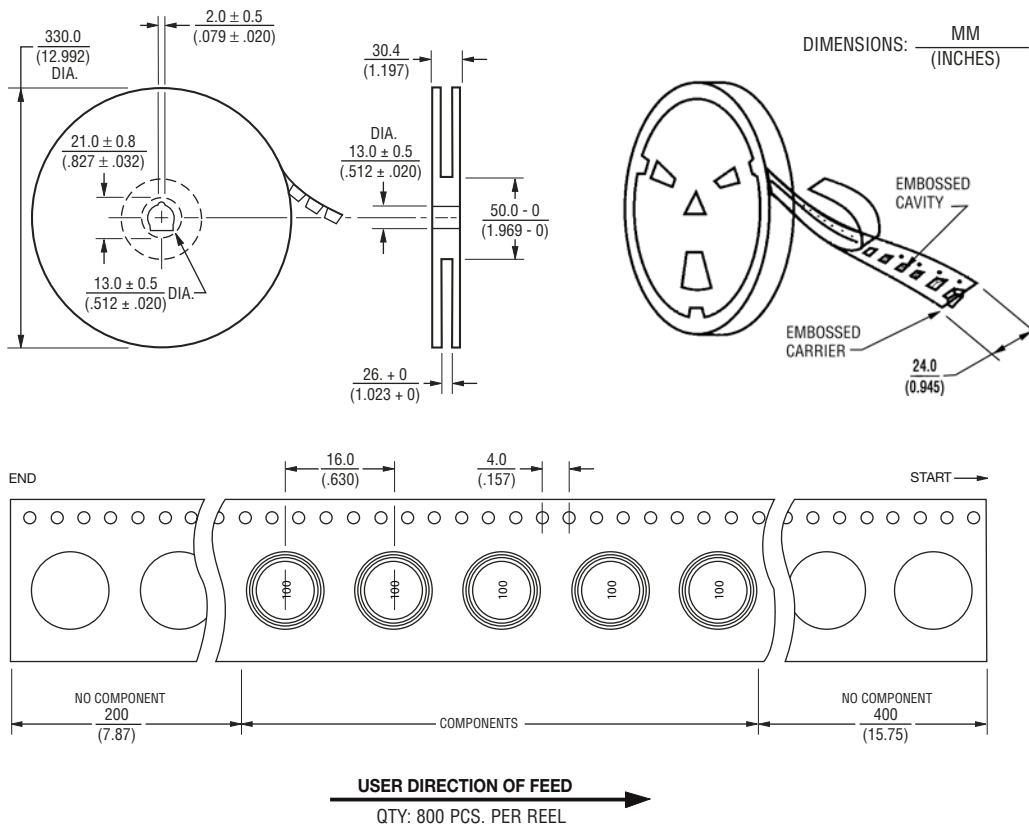

11/08

Specifications are subject to change without notice.  
Customers should verify actual device performance in their specific applications.