

P6SMB6.8CA
THRU
P6SMB250CA



**SURFACE MOUNT
BI-DIRECTIONAL
GLASS PASSIVATED JUNCTION
SILICON TRANSIENT
VOLTAGE SUPPRESSOR
600 WATTS, 6.8 THRU 250 VOLTS**



www.centrasemi.com

DESCRIPTION:

The CENTRAL SEMICONDUCTOR P6SMB6.8CA Series types are Surface Mount Bi-Directional Glass Passivated Junction Transient Voltage Suppressors designed to protect voltage sensitive components from high voltage transients.

THIS DEVICE IS MANUFACTURED WITH A GLASS PASSIVATED CHIP FOR OPTIMUM RELIABILITY.

Note: For Uni-directional devices, please refer to the P6SMB6.8A Series data sheet.

MARKING CODE: SEE ELECTRICAL CHARACTERISTICS TABLE

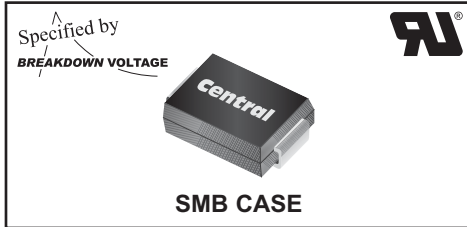

• This series is UL listed, UL file number E130224

MAXIMUM RATINGS: ($T_A=25^\circ\text{C}$ unless otherwise noted)

Peak Power Dissipation (Note 1)

Operating and Storage Junction Temperature

SYMBOL

P_{PK} 600
 T_J, T_{stg} -65 to +150

UNITS

W
 $^\circ\text{C}$

ELECTRICAL CHARACTERISTICS: ($T_A=25^\circ\text{C}$ unless otherwise noted)

TYPE	BREAKDOWN VOLTAGE			TEST CURRENT I_T	WORKING PEAK REVERSE VOLTAGE V_{RWM}	MAXIMUM REVERSE LEAKAGE CURRENT $I_R @ V_{RWM}$	MAXIMUM CLAMPING VOLTAGE $V_C @ I_{PP}$	PEAK PULSE CURRENT (Note 1) I_{PP}	MAXIMUM TEMPERATURE COEFFICIENT $\theta_{V_{BR}}$	MARKING CODE
	$V_{BR} @ I_T$									
	MIN V	NOM V	MAX V	mA	V	μA	V	A	% / $^\circ\text{C}$	
P6SMB6.8CA	6.45	6.8	7.14	10	5.8	2000	10.5	57	0.057	C6V8C
P6SMB7.5CA	7.13	7.5	7.88	10	6.4	1000	11.3	53	0.061	C7V5C
P6SMB8.2CA	7.79	8.2	8.61	10	7.02	400	12.1	50	0.065	C8V2C
P6SMB9.1CA	8.65	9.1	9.55	1.0	7.78	100	13.4	45	0.068	C9V1C
P6SMB10CA	9.5	10	10.5	1.0	8.55	20	14.5	41	0.073	C10C
P6SMB11CA	10.5	11	11.6	1.0	9.4	5.0	15.6	38	0.075	C11C
P6SMB12CA	11.4	12	12.6	1.0	10.2	5.0	16.7	36	0.078	C12C
P6SMB13CA	12.4	13	13.7	1.0	11.1	5.0	18.2	33	0.081	C13C
P6SMB15CA	14.3	15	15.8	1.0	12.8	5.0	21.2	28	0.084	C15C
P6SMB16CA	15.2	16	16.8	1.0	13.6	5.0	22.5	27	0.086	C16C
P6SMB18CA	17.1	18	18.9	1.0	15.3	5.0	25.2	24	0.088	C18C
P6SMB20CA	19	20	21.0	1.0	17.1	5.0	27.7	22	0.090	C20C
P6SMB22CA	20.9	22	23.1	1.0	18.8	5.0	30.6	20	0.092	C22C
P6SMB24CA	22.8	24	25.2	1.0	20.5	5.0	33.2	18	0.094	C24C
P6SMB27CA	25.7	27	28.4	1.0	23.1	5.0	37.5	16	0.096	C27C
P6SMB30CA	28.5	30	31.5	1.0	25.6	5.0	41.4	14.4	0.097	C30C
P6SMB33CA	31.4	33	34.7	1.0	28.2	5.0	45.7	13.2	0.098	C33C
P6SMB36CA	34.2	36	37.8	1.0	30.8	5.0	49.9	12	0.099	C36C
P6SMB39CA	37.1	39	41	1.0	33.3	5.0	53.9	11.2	0.100	C39C

Notes: (1) Non-repetitive 10x1,000 μs pulse.

R7 (8-September 2011)

**P6SMB6.8CA
THRU
P6SMB250CA**

**SURFACE MOUNT
BI-DIRECTIONAL
GLASS PASSIVATED JUNCTION
SILICON TRANSIENT
VOLTAGE SUPPRESSOR
600 WATTS, 6.8 THRU 250 VOLTS**



ELECTRICAL CHARACTERISTICS - Continued: ($T_A=25^{\circ}\text{C}$ unless otherwise noted)

TYPE	BREAKDOWN VOLTAGE			TEST CURRENT I_T	WORKING PEAK REVERSE VOLTAGE V_{RWM}	MAXIMUM REVERSE LEAKAGE CURRENT $I_R @ V_{RWM}$	MAXIMUM CLAMPING VOLTAGE $V_C @ I_{PP}$	PEAK PULSE CURRENT (Note 1) I_{PP}	MAXIMUM TEMPERATURE COEFFICIENT θ_{VBR}	MARKING CODE
	$V_{BR} @ I_T$									
	MIN V	NOM V	MAX V	mA	V	μA	V	A	% / $^{\circ}\text{C}$	
P6SMB43CA	40.9	43	45.2	1.0	36.8	5.0	59.3	10.1	0.101	C43C
P6SMB47CA	44.7	47	49.4	1.0	40.2	5.0	64.8	9.3	0.101	C47C
P6SMB51CA	48.5	51	53.6	1.0	43.6	5.0	70.1	8.6	0.102	C51C
P6SMB56CA	53.2	56	58.8	1.0	47.8	5.0	77	7.8	0.103	C56C
P6SMB62CA	58.9	62	65.1	1.0	53	5.0	85	7.1	0.104	C62C
P6SMB68CA	64.6	68	71.4	1.0	58.1	5.0	92	6.5	0.104	C68C
P6SMB75CA	71.3	75	78.8	1.0	64.1	5.0	103	5.8	0.105	C75C
P6SMB82CA	77.9	82	86.1	1.0	70.1	5.0	113	5.3	0.105	C82C
P6SMB91CA	86.5	91	95.5	1.0	77.8	5.0	125	4.8	0.106	C91C
P6SMB100CA	95	100	105	1.0	85.5	5.0	137	4.4	0.106	C100C
P6SMB110CA	104.5	110	115.5	1.0	94	5.0	152	4.0	0.107	C110C
P6SMB120CA	114	120	126	1.0	102	5.0	165	3.6	0.107	C120C
P6SMB130CA	123.5	130	136.5	1.0	111	5.0	179	3.3	0.107	C130C
P6SMB150CA	142.5	150	157.5	1.0	128	5.0	207	2.9	0.108	C150C
P6SMB160CA	152	160	168	1.0	136	5.0	219	2.7	0.108	C160C
P6SMB170CA	161.5	170	178.5	1.0	145	5.0	234	2.6	0.108	C170C
P6SMB180CA	171	180	189	1.0	154	5.0	246	2.4	0.108	C180C
P6SMB200CA	190	200	210	1.0	171	5.0	274	2.2	0.108	C200C
P6SMB220CA	209	220	231	1.0	185	5.0	328	1.8	0.108	C220C
P6SMB250CA	237.5	250	262.5	1.0	214	5.0	344	1.7	0.110	C250C

SMB CASE - MECHANICAL OUTLINE

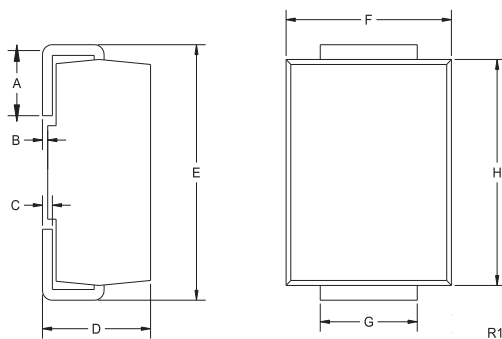

SYMBOL	DIMENSIONS			
	INCHES		MILLIMETERS	
	MIN	MAX	MIN	MAX
A	0.030	0.060	0.76	1.52
B	0.004	0.008	0.10	0.20
C	0.006	0.012	0.15	0.30
D	0.086	0.096	2.18	2.44
E	0.200	0.220	5.08	5.59
F	0.130	0.150	3.30	3.81
G	0.077	0.083	1.96	2.11
H	0.160	0.180	4.06	4.57

SMB (REV: R1)

R7 (8-September 2011)

**P6SMB6.8CA
THRU
P6SMB250CA**

**SURFACE MOUNT
BI-DIRECTIONAL
GLASS PASSIVATED JUNCTION
SILICON TRANSIENT
VOLTAGE SUPPRESSOR
600 WATTS, 6.8 THRU 250 VOLTS**



TYPICAL ELECTRICAL CHARACTERISTICS

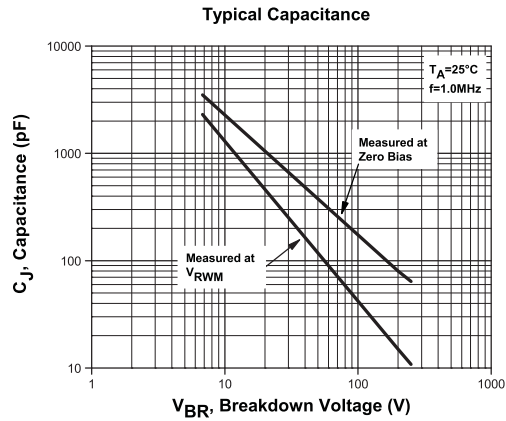
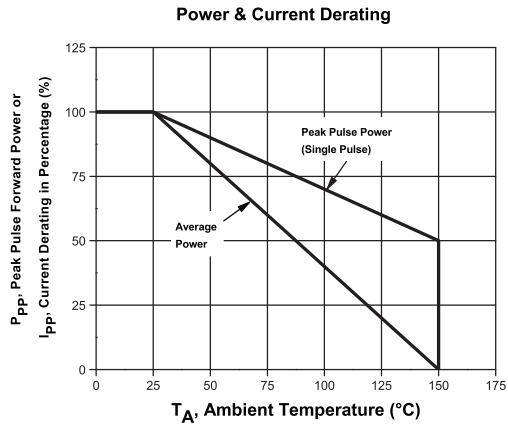
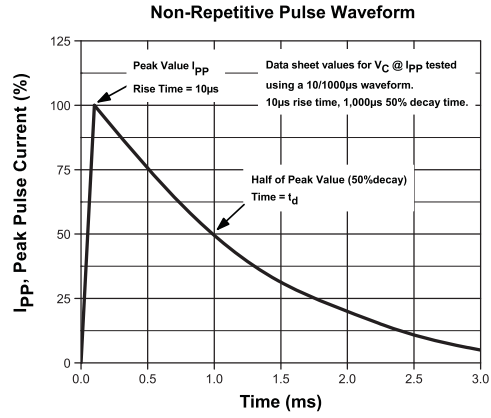
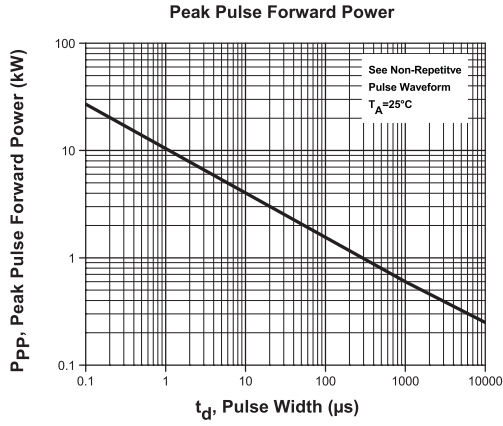

R7 (8-September 2011)