

## DUAL OPERATIONAL AMPLIFIER

### ■ GENERAL DESCRIPTION

The NJM4560 integrated circuit is a high-gain, wide bandwidth, dual operational amplifier capable of driving 20V peak-to-peak into 400Ω loads. The NJM4560 combines many of the features of the NJM4558 as well as providing the capability of wider bandwidth, and higher slew rate make the NJM4560 ideal for active filters, data and telecommunications, and many instrumentation applications. The availability of the NJM4560 in the surface mounted micro-package allows the NJM4560 to be used in critical applications requiring very high packing densities.

### ■ FEATURES

- Operating Voltage ( ±4V~±18V )
- Wide Gain Bandwidth Product ( 10MHz typ. )
- Slew Rate ( 4V/μs typ. )
- Package Outline DIP8, DMP8, SIP8, SOP8 JEDEC 150mil
- Bipolar Technology

### ■ PACKAGE OUTLINE

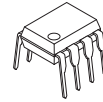

**NJM4560D**  
( DIP8 )



**NJM4560M**  
( DMP8 )



**NJM4560E**  
( SOP8 )

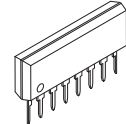

**NJM4560L**  
( SIP8 )

### ■ PIN CONFIGURATION

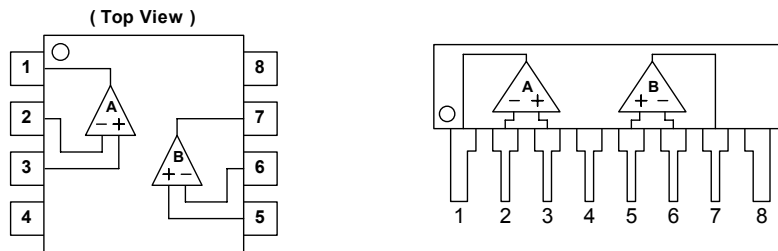

NJM4560D, NJM4560M, NJM4560E

NJM4560L

### PIN FUNCTION

1. A OUTPUT
2. A - INPUT
3. A + INPUT
4. V<sup>-</sup>
5. B + INPUT
6. B - INPUT
7. B OUTPUT
8. V<sup>+</sup>

### ■ EQUIVALENT CIRCUIT ( 1/2 Shown )

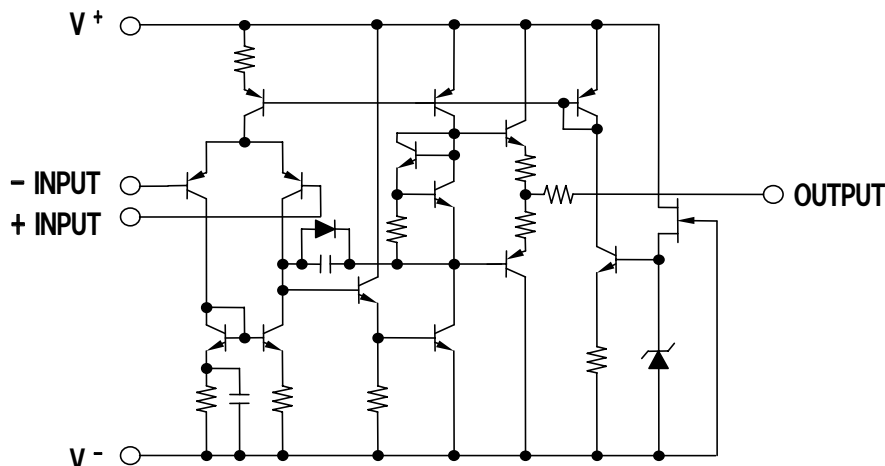

# NJM4560

## ■ ABSOLUTE MAXIMUM RATINGS

( Ta=25°C )

PARAMETER	SYMBOL	RATINGS	UNIT
Supply Voltage	$V^+ / V^-$	± 18	V
Differential Input Voltage	$V_{ID}$	± 30	V
Input Voltage	$V_{IC}$	± 15 ( note )	V
Power Dissipation	$P_D$	( DIP8 ) 500 ( DMP8 ) 300 ( SOP8 ) 300 ( SIP8 ) 800	mW
Operating Temperature Range	$T_{opr}$	-40~+85	°C
Storage Temperature Range	$T_{stg}$	-40~+125	°C

( note ) For supply voltage less than ±15V, the absolute maximum input voltage is equal to the supply voltage.

## ■ ELECTRICAL CHARACTERISTICS

( Ta=25°C,  $V^+ / V^- = \pm 15V$  )

PARAMETER	SYMBOL	TEST CONDITION	MIN.	TYP.	MAX.	UNIT
Input Offset Voltage	$V_{IO}$	$R_S \leq 10k\Omega$	-	0.5	6	mV
Input Offset Current	$I_{IO}$		-	5	200	nA
Input Bias Current	$I_B$		-	40	500	nA
Input Resistance	$R_{IN}$		0.3	5	-	MΩ
Large Signal Voltage Gain	$A_V$	$R_L \geq 2k\Omega, V_O = \pm 10V$	86	100	-	dB
Maximum Output Voltage Swing 1	$V_{OM1}$	$R_L \geq 2k\Omega$	± 12	± 14	-	V
Maximum Output Voltage Swing 2	$V_{OM2}$	$I_O = 25mA$	± 10	± 11.5	-	V
Input Common Mode Voltage Range	$V_{ICM}$		± 12	± 14	-	V
Common Mode Rejection Ratio	CMR	$R_S \leq 10k\Omega$	70	90	-	dB
Supply Voltage Rejection Ratio	SVR	$R_S \leq 10k\Omega$	76.5	90	-	dB
Operating Current	$I_{CC}$		-	4.3	5.7	mA
Slew Rate	SR		-	4	-	V/μs
Gain Bandwidth Product	GB		-	10	-	MHz
Equivalent Input Noise Voltage	$V_{NI}$	RIAA, $R_S = 2k\Omega, 30kHz$ LPF	-	1.2	-	μVrms

## ■ TYPICAL CHARACTERISTICS

**Open Loop Voltage Gain vs. Frequency**

( $V^+/V^- = \pm 15V$ ,  $R_L = 2k\Omega$ ,  $T_a = 25^\circ C$ )

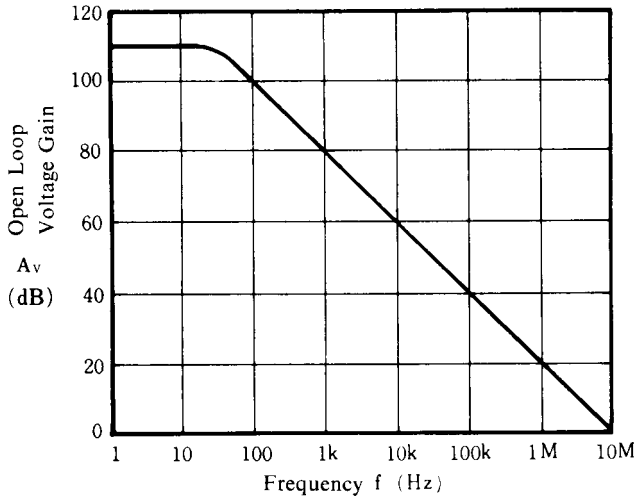

**Maximum Output Voltage Swing vs. Frequency**

( $V^+/V^- = \pm 15V$ ,  $T_a = 25^\circ C$ )

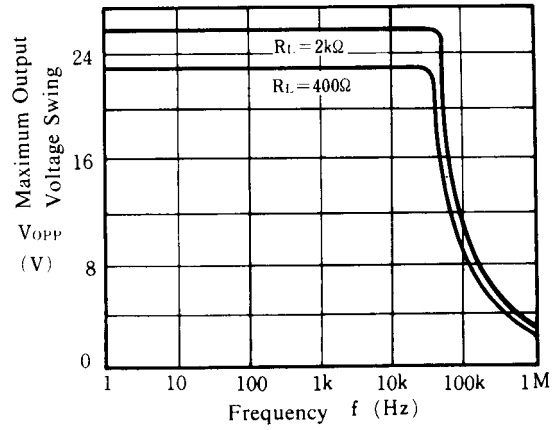

**Maximum Output Voltage Swing vs. Load Resistance**

( $V^+/V^- = \pm 15V$ ,  $T_a = 25^\circ C$ )

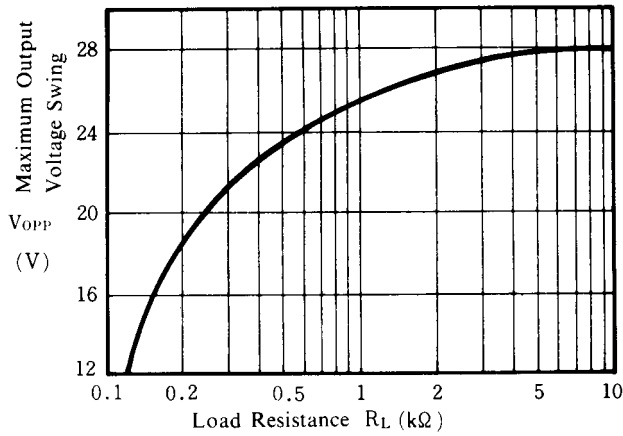

**Equivalent Input Noise Voltage vs. Frequency**

( $V^+/V^- = \pm 15V$ ,  $R_s = 50\Omega$ ,  $A_v = 60dB$ ,  $T_a = 25^\circ C$ )

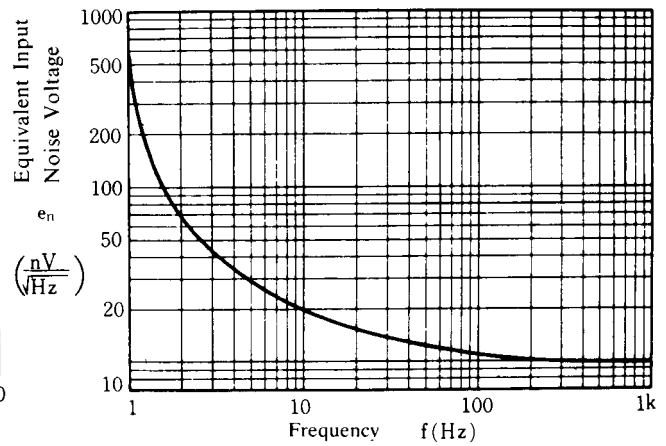

**Operating Current vs. Temperature**

( $V^+/V^- = \pm 15V$ )

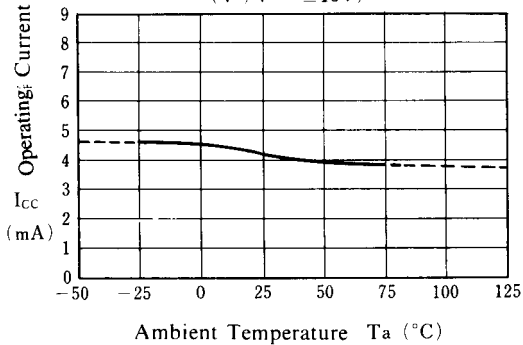

**Maximum Output Voltage Swing vs. Temperature**

( $V^+/V^- = \pm 15V$ ,  $R_L = 2k\Omega$ )

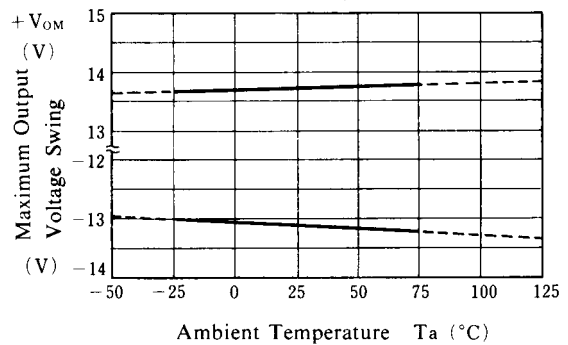

## ■ TYPICAL CHARACTERISTICS

**Input Offset Voltage vs. Temperature**

( $V^+/V^- = \pm 15V$ )

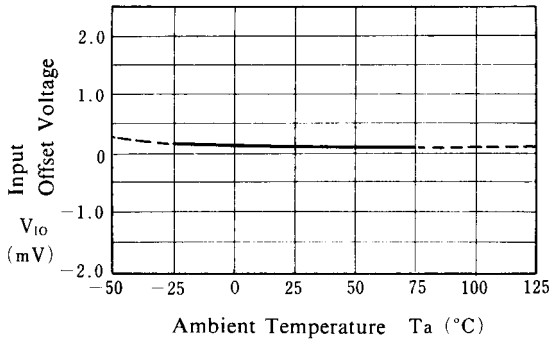

**Input Bias Current vs. Temperature**

( $V^+/V^- = \pm 15V$ )

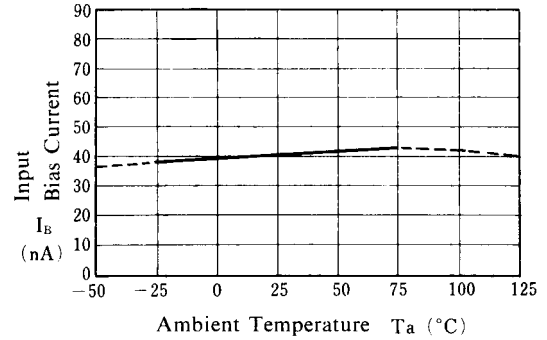

**Maximum Output Voltage Swing vs. Supply Voltage**

( $R_L = 400\Omega, T_a = 25^\circ C$ )

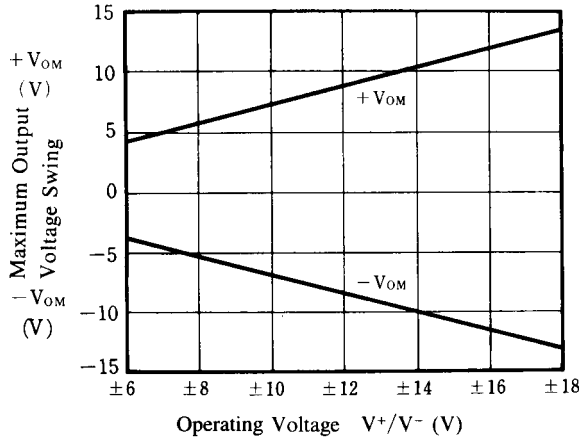

**Operating Current vs. Operating Voltage**

( $T_a = 25^\circ C$ )

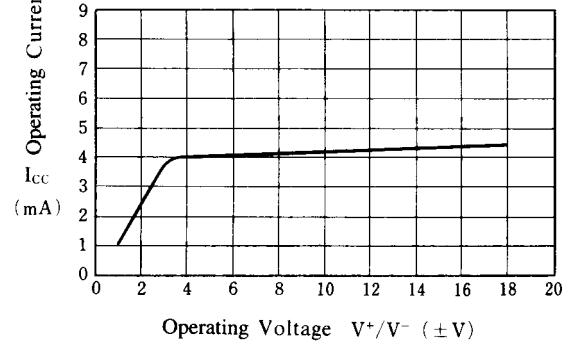

**[CAUTION]**

The specifications on this databook are only given for information, without any guarantee as regards either mistakes or omissions. The application circuits in this databook are described only to show representative usages of the product and not intended for the guarantee or permission of any right including the industrial rights.