

DUAL OPERATIONAL AMPLIFIER

■ GENERAL DESCRIPTION

The NJM4562 integrated circuit is a high-gain, wide-bandwidth, low noise, dual operational amplifier capable of driving 20V peak-to-peak into 600Ω loads. The NJM4562 is frequency compensated for closed loop gains greater than 10. The NJM4562 combines many of the features of the popular NJM4558 as well as providing the capability of wider bandwidth, and higher slew rate and less noise make the NJM4562 ideal for audio preamplifiers, active filters, telecommunications, and many instrumentation applications. The availability of the NJM4562 in the surface mounted micro package allows the NJM4562 to be used in critical applications requiring very high packing densities.

■ PACKAGE OUTLINE

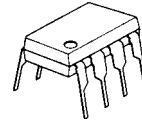

NJM4562D



NJM4562M

■ FEATURES

- Operating Voltage (±4V~±18V)
- Low Input Noise Voltage (0.6μVrms typ.)
- Package Outline DIP8,DMP8
- Bipolar Technology

■ PIN CONFIGURATION

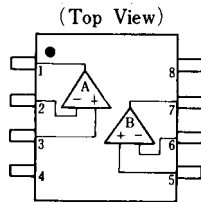

NJM4562D
NJM4562M

- PIN FUNCTION**
- 1.A OUTPUT
 - 2.A -INPUT
 - 3.A +INPUT
 - 4.V⁻
 - 5.B +INPUT
 - 6.B -INPUT
 - 7.B OUTPUT
 - 8.V⁺

■ EQUIVALENT CIRCUIT (1/2 Shown)

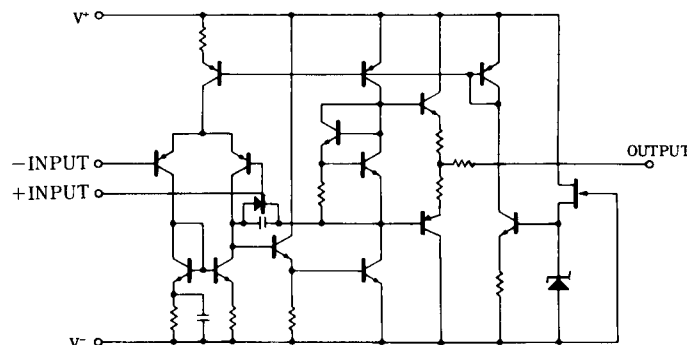

NJM4562

■ ABSOLUTE MAXIMUM RATINGS

(Ta=25°C)

PARAMETER	SYMBOL	RATINGS	UNIT
Supply Voltage	V^+ / V^-	± 18	V
Differential Input Voltage	V_{ID}	± 30	V
Input Voltage	V_{IC}	± 15 (note)	V
Power Dissipation	P_D	(DIP8) 500 (DMP8) 300	mW
Operating Temperature Range	T_{opr}	-40~+85	°C
Storage Temperature Range	T_{stg}	-40~+125	°C

(note) For supply voltage less than ±15V, the absolute maximum input voltage is equal to the supply voltage.

■ ELECTRICAL CHARACTERISTICS

(Ta=25°C, $V^+ / V^- = \pm 15V$)

PARAMETER	SYMBOL	TEST CONDITION	MIN.	TYP.	MAX.	UNIT
Input Offset Voltage	V_{IO}	$R_S \leq 10k\Omega$	-	0.5	6	mV
Input Offset Current	I_{IO}		-	5	200	nA
Input Bias Current	I_B		-	100	500	nA
Input Resistance	R_{IN}		0.3	5	-	MΩ
Large Signal Voltage Gain	A_V	$R_L \geq 2k\Omega, V_O = \pm 10V$	86	110	-	dB
Maximum Output Voltage Swing 1	V_{OM1}	$R_L \geq 10k\Omega$	± 12	± 14	-	V
Maximum Output Voltage Swing 2	V_{OM2}	$R_L \geq 2k\Omega$	± 10	± 13	-	V
Input Common Mode Voltage Range	V_{ICM}		± 12	± 14	-	V
Common Mode Rejection Ratio	CMR	$R_S \leq 10k\Omega$	70	90	-	dB
Supply Voltage Rejection Ratio	SVR	$R_S \leq 10k\Omega$	76.5	90	-	dB
Operating Current	I_{CC}		-	3.5	5.7	mA
Equivalent Input Noise Voltage	V_{NI}	$R_S = 300\Omega, JISA$	-	0.6	-	μVrms

■ TYPICAL CHARACTERISTICS

Open Loop Voltage Gain vs. Frequency

($V^+/V^- = \pm 15V$, $R_L = 2k\Omega$, $T_a = 25^\circ C$)

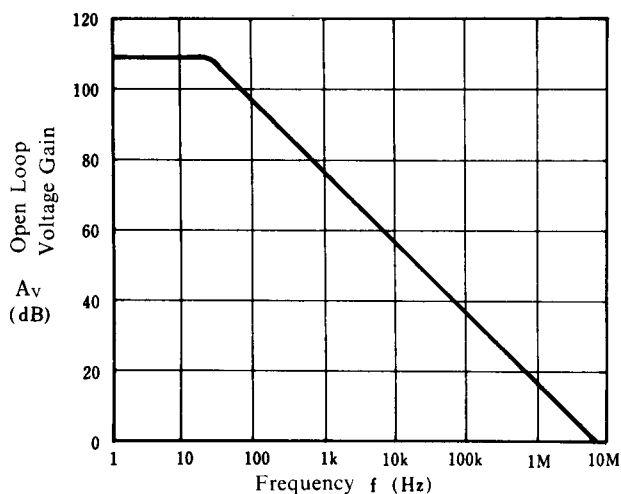

Total Harmonic Distortion vs. Output Voltage

($V^+/V^- = \pm 15V$, $R_L = 2k\Omega$, $T_a = 25^\circ C$)

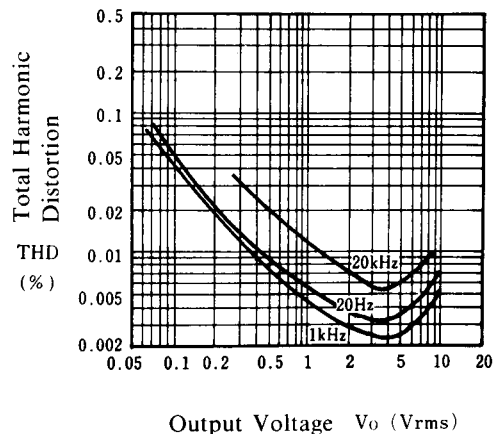

Maximum Output Voltage Swing vs. Load Resistance

($V^+/V^- = \pm 15V$, $T_a = 25^\circ C$)

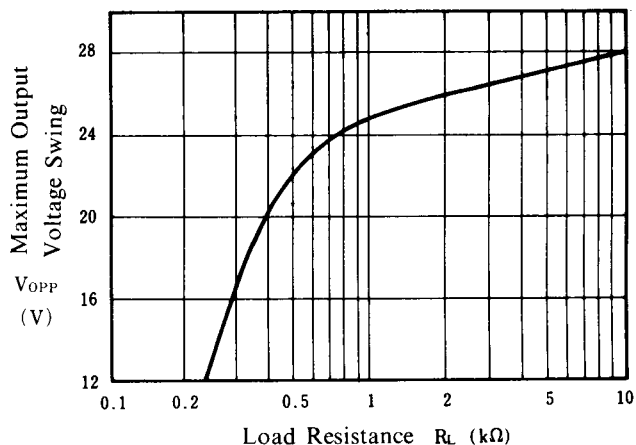

Equivalent Input Noise Voltage vs. Rs

($V^+/V^- = \pm 15V$, $T_a = 25^\circ C$)

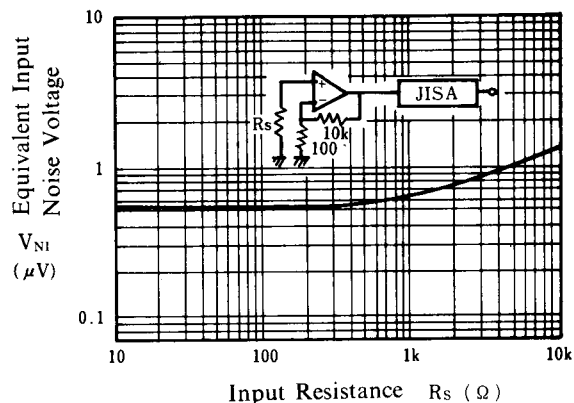

Operating Current vs. Temperature

($V^+/V^- = \pm 15V$)

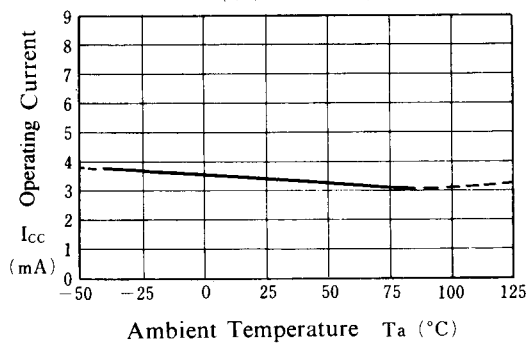

Maximum Output Voltage Swing vs. Temperature

($V^+/V^- = \pm 15V$)

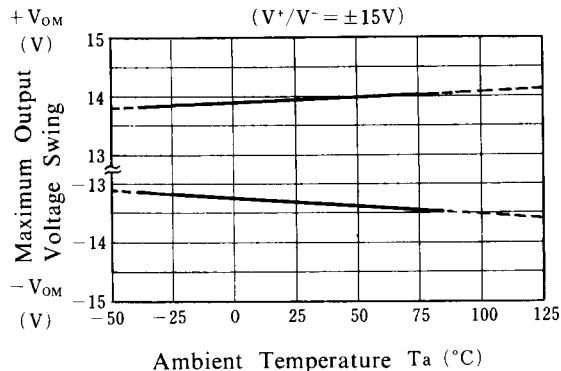

■ TYPICAL CHARACTERISTICS

Input Offset Voltage vs. Temperature

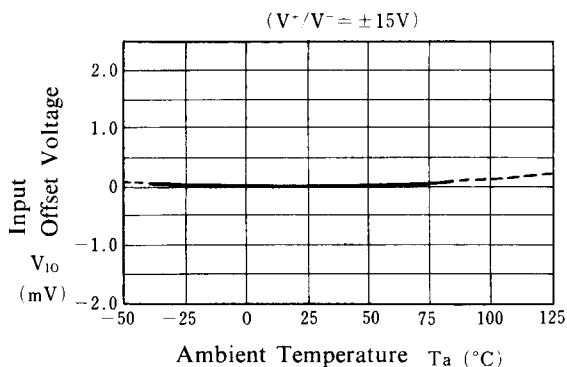

Input Bias Current vs. Temperature

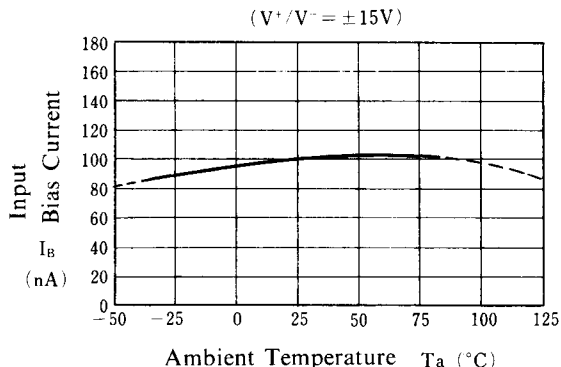

Maximum Output Voltage Swing vs. Operating Voltage

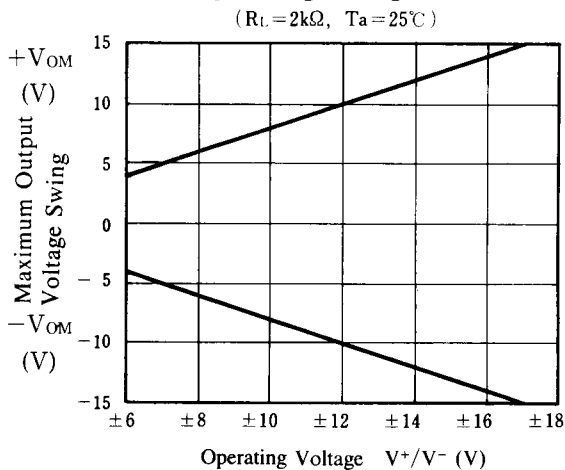

Operating Current vs. Operating Voltage

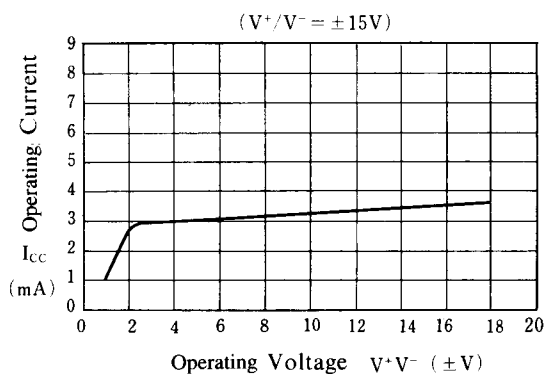

Maximum Output Voltage vs. Frequency

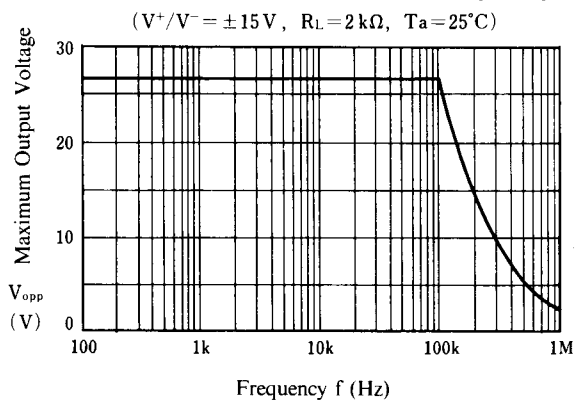

[CAUTION]
 The specifications on this databook are only given for information, without any guarantee as regards either mistakes or omissions. The application circuits in this databook are described only to show representative usages of the product and not intended for the guarantee or permission of any right including the industrial rights.