

SINGLE GENERAL PURPOSE OPERATIONAL AMPLIFIER

■ GENERAL DESCRIPTION

The NJM741 is a high performance Monolithic Operational Amplifier constructed using the New JRC Planar epitaxial process. It is intended for a wide range of analog applications. High common mode voltage range and absence of latch-up tendencies make the NJM741 ideal for use as a voltage follower. The high gain and wide range of operating voltage provides superior performance in integrator, summing amplifier, and general feedback applications.

■ PACKAGE OUTLINE

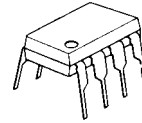

NJM741D



NJM741M

■ FEATURES

- Operating Voltage ($\pm 3V \sim \pm 18V$)
- Single Supply
- With V_{IO} Trim Terminal DIP8, DMP8
- Package Outline
- Bipolar Technology

■ PIN CONFIGURATION

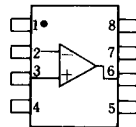

NJM741D
NJM741M

PIN FUNCTION

- 1. V_{OS} Trim
- 2. -INPUT
- 3. +INPUT
- 4. V^-
- 5. V_{OS} Trim
- 6. OUTPUT
- 7. V^+
- 8. NC

■ EQUIVALENT CIRCUIT

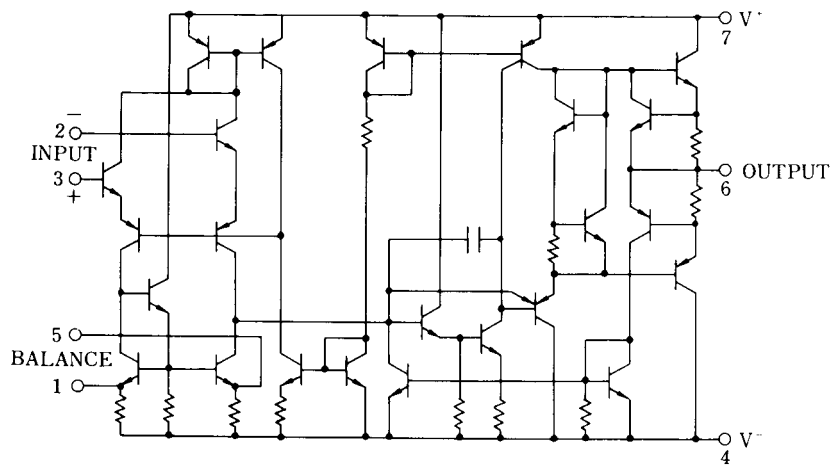

NJM741

■ ABSOLUTE MAXIMUM RATINGS

(Ta=25°C)

PARAMETER	SYMBOL	RATINGS	UNIT
Supply Voltage	V^+V^-	± 18	V
Input Voltage	V_{IC}	± 15 (note)	V
Differential Input Voltage	V_{ID}	± 30	V
Power Dissipation	P_D	(DIP8) 500 (DMP8) 300	mW
Operating Temperature Range	T_{opr}	-40~+85	°C
Storage Temperature Range	T_{stg}	-40~+125	°C

(note) For supply voltage less than $\pm 15V$, the absolute maximum input voltage is equal to the supply voltage.

■ ELECTRICAL CHARACTERISTICS

(Ta=+25°C, $V^+V^- = \pm 15V$)

PARAMETER	SYMBOL	TEST CONDITION	MIN.	TYP.	MAX.	UNIT
Input Offset Voltage	V_{IO}	$R_S \leq 10k\Omega$	-	2.0	6.0	mV
Input Offset Current	I_{IO}		-	5	200	nA
Input Bias Current	I_{IB}		-	30	500	nA
Input Resistance	R_{IN}		0.3	2.0	-	M Ω
Large-signal Voltage Gain	A_V	$R_L \geq 2k\Omega, V_O = \pm 10V$	86	110	-	dB
Maximum Output Voltage Swing 1	V_{OM1}	$R_L \geq 10k\Omega$	± 12	± 14	-	V
Maximum Output Voltage Swing 2	V_{OM2}	$R_L \geq 2k\Omega$	± 10	± 13	-	V
Input Common Mode Voltage Range	V_{ICM}		± 12	± 13	-	V
Common Mode Rejection Ratio	CMR	$R_S \leq 10k\Omega$	70	100	-	dB
Supply Voltage Rejection Ratio	SVR	$R_S \leq 10k\Omega$	76.5	100	-	dB
Operating Current	I_{CC}		-	1.7	2.8	mA
Slew Rate	SR	$R_L \geq 2k\Omega$	-	0.5	-	V/ μs
Transient Response (Unity Gain)(Rise Time)	t_R	$V_{IN} = 20mV, R_L = 2k\Omega, C_L = 100pF$	-	0.3	-	μs
Transient Response (Unity Gain)(Overshoot)	t_O	$V_{IN} = 20mV, R_L = 2k\Omega, C_L = 100pF$	-	5.0	-	%

■ TYPICAL CHARACTERISTICS

Maximum Output Voltage Swing vs. Frequency

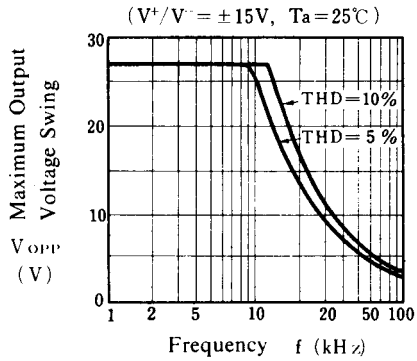

Maximum Output Voltage Swing vs. Load Resistance

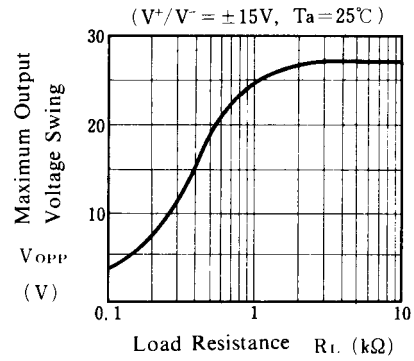

Input Bias Current vs. Temperature

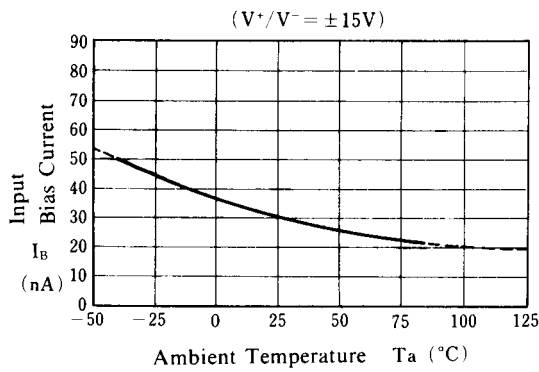

Maximum Output Voltage Swing vs. Operating Voltage

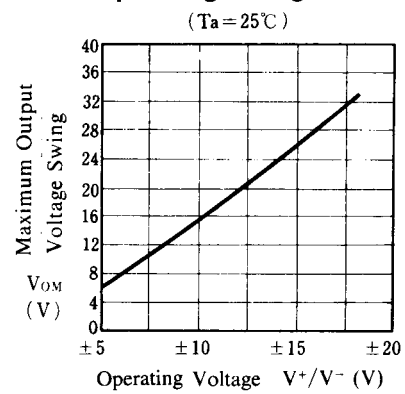

Voltage-follower Large-signal Pulse Response

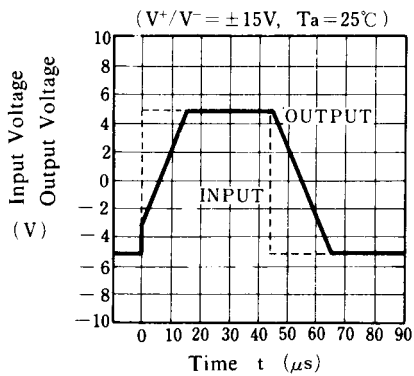

Voltage Gain, Phase vs. Frequency

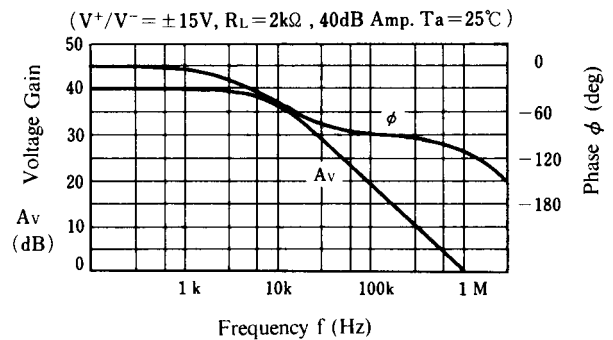

NJM741

■ TYPICAL CHARACTERISTICS

Operating Current vs. Temperature

($V^+/V^- = \pm 15\text{ V}$)

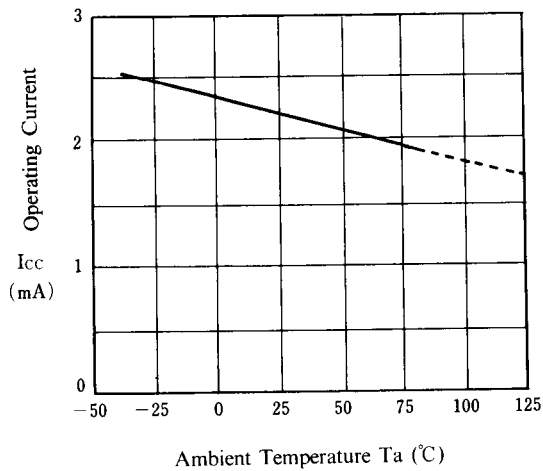

Input Offset Voltage vs. Temperature

($V^+/V^- = \pm 15\text{ V}$)

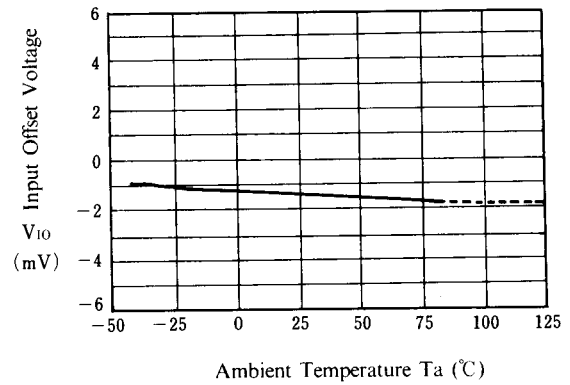

Maximum Output Voltage vs. Temperature

($V^+/V^- = \pm 15\text{ V}$, $R_L = 10\text{ k}\Omega$)

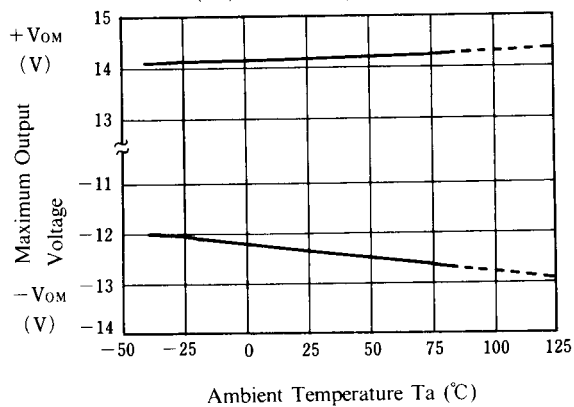

■ OFFSET ADJUSTMENT CIRCUIT

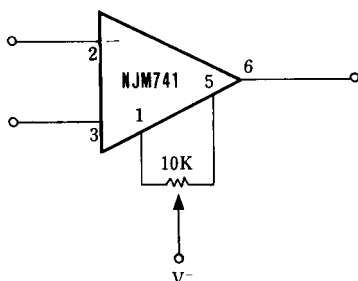

[CAUTION]

The specifications on this databook are only given for information, without any guarantee as regards either mistakes or omissions. The application circuits in this databook are described only to show representative usages of the product and not intended for the guarantee or permission of any right including the industrial rights.