

# 8-bit Microcontrollers

## CMOS

## New 8FX MB95310L/370L Series

**MB95F314E/F314L/F316E/F316L/F318E/F318L**  
**MB95F374E/F374L/F376E/F376L/F378E/F378L**

### ■ DESCRIPTION

MB95310L/370L is a series of general-purpose, single-chip microcontrollers. In addition to a compact instruction set, the microcontrollers of this series contain a variety of peripheral resources.

### ■ FEATURES

- F<sup>2</sup>MC-8FX CPU core

Instruction set optimized for controllers

- Multiplication and division instructions
- 16-bit arithmetic operations
- Bit test branch instructions
- Bit manipulation instructions, etc.

Note: F<sup>2</sup>MC is the abbreviation of FUJITSU Flexible Microcontroller.

- Clock

- Selectable main clock source

Main OSC clock (up to 16.25 MHz, maximum machine clock frequency: 8.125 MHz)

External clock (up to 32.5 MHz, maximum machine clock frequency: 16.25 MHz)

Main CR clock (1/8/10/12.5 MHz  $\pm$ 2%, maximum machine clock frequency: 12.5 MHz)

Main PLL clock (up to 16.25 MHz, maximum machine clock frequency: 16.25 MHz)

- Selectable subclock source

Sub-OSC clock (32.768 kHz)

External clock (32.768 kHz)

Sub-CR clock (Typ: 100 kHz, Min: 50 kHz, Max: 200 kHz)

- Timer

- 8/16-bit composite timer
- 8/16-bit PPG
- 16-bit reload timer
- Event counter
- Time-base timer
- Watch prescaler

- UART-SIO

- Capable of clock-asynchronous (UART) serial data transfer and clock-synchronous (SIO) serial data transfer
- Full duplex double buffer

(Continued)

For the information for microcontroller supports, see the following website.

<http://edevic.fujitsu.com/micom/en-support/>

# MB95310L/370L Series

(Continued)

- I<sup>2</sup>C
  - Built-in wake-up function
- External interrupt
  - Interrupt by edge detection (rising edge, falling edge, and both edges can be selected)
  - Can be used to wake up the device from different low power consumption (standby) modes
- 8/10-bit A/D converter
  - 8-bit or 10-bit resolution can be selected
- LCD controller (LCDC)
  - 40 SEG × 4 COM (MB95F314E/F314L/F316E/F316L/F318E/F318L)
  - 32 SEG × 4 COM (MB95F374E/F374L/F376E/F376L/F378E/F378L)
  - Internal divider resistor
  - With blinking function
- Low power consumption (standby) modes
  - Stop mode
  - Sleep mode
  - Watch mode
  - Time-base timer mode
- I/O port
  - MB95F314E/F314L/F316E/F316L/F318E/F318L (maximum no. of I/O ports: 71)
    - General-purpose I/O ports (N-ch open drain) : 3
    - General-purpose I/O ports (CMOS I/O) : 68
  - MB95F374E/F374L/F376E/F376L/F378E/F378L (maximum no. of I/O ports: 55)
    - General-purpose I/O ports (N-ch open drain) : 3
    - General-purpose I/O ports (CMOS I/O) : 52
- On-chip debug
  - 1-wire serial control
  - Serial writing supported (asynchronous mode)
- Hardware/software watchdog timer
  - Built-in hardware watchdog timer
  - Built-in software watchdog timer
- Low-voltage detection reset circuit
  - Built-in low-voltage detector
  - Three configurable low-voltage detection levels for generating reset
  - Five configurable low-voltage detection levels for generating interrupts
- Clock supervisor counter
  - Built-in clock supervisor counter function
- Programmable port input voltage level
  - CMOS input level / hysteresis input level
- Dual operation Flash memory
  - The program/erase operation and the read operation can be executed in different banks (upper bank/lower bank) simultaneously.
- Flash memory security function
  - Protects the content of the Flash memory

# MB95310L/370L Series

## ■ PRODUCT LINE-UP

### • MB95310L Series

Part number	MB95F314E	MB95F316E	MB95F318E	MB95F314L	MB95F316L	MB95F318L
Parameter						
Type	Flash memory product					
Clock supervisor counter	It supervises the main clock oscillation.					
Flash memory capacity	20 Kbyte	36 Kbyte	60 Kbyte	20 Kbyte	36 Kbyte	60 Kbyte
RAM capacity	496 bytes	1008 bytes	2032 bytes	496 bytes	1008 bytes	2032 bytes
Low-voltage detection reset	Yes			No		
Reset input	Dedicated					
CPU functions	<ul style="list-style-type: none"> <li>• Number of basic instructions : 136</li> <li>• Instruction bit length : 8 bits</li> <li>• Instruction length : 1 to 3 bytes</li> <li>• Data bit length : 1, 8 and 16 bits</li> <li>• Minimum instruction execution time : 61.5 ns (machine clock frequency = 16.25 MHz)</li> <li>• Interrupt processing time : 0.6 μs (machine clock frequency = 16.25 MHz)</li> </ul>					
General-purpose I/O	<ul style="list-style-type: none"> <li>• I/O ports (Max) : 71</li> <li>• CMOS I/O : 68</li> <li>• N-ch open drain: 3</li> </ul>					
Time-base timer	Interval time: 0.256 ms - 8.3 s (external clock frequency = 4 MHz)					
Hardware/software watchdog timer	<ul style="list-style-type: none"> <li>• Reset generation cycle Main oscillation clock at 10 MHz: 105 ms (Min)</li> <li>• The sub-CR clock can be used as the source clock of the hardware watchdog timer.</li> </ul>					
Wild register	It can be used to replace three bytes of data.					
I <sup>2</sup> C	1 channel					
	<ul style="list-style-type: none"> <li>• Master/Slave sending and receiving</li> <li>• Bus error function and arbitration function</li> <li>• Detecting transmitting direction function</li> <li>• Start condition repeated generation and detection functions</li> <li>• Built-in wake-up function</li> </ul>					
UART/SIO	2 channels					
	<ul style="list-style-type: none"> <li>• Data transfer with UART/SIO is enabled.</li> <li>• It has a full duplex double buffer, variable data length (5/6/7/8 bits), a built-in baud rate generator and an error detection function.</li> <li>• It uses the NRZ type transfer format.</li> <li>• LSB-first data transfer and MSB-first data transfer are available to use.</li> <li>• Clock-asynchronous (UART) serial data transfer and clock-synchronous (SIO) serial data transfer is enabled.</li> </ul>					
8/10-bit A/D converter	4 channels					
	8-bit or 10-bit resolution can be selected.					

(Continued)

# MB95310L/370L Series

(Continued)

Part number	MB95F314E	MB95F316E	MB95F318E	MB95F314L	MB95F316L	MB95F318L
Parameter						
8/16-bit composite timer	2 channels <ul style="list-style-type: none"> <li>Each timer can be configured as an "8-bit timer × 2 channels" or a "16-bit timer × 1 channel".</li> <li>It has built-in timer function, PWC function, PWM function and input capture function.</li> <li>Count clock: it can be selected from internal clocks (seven types) and external clocks.</li> <li>It can output square wave.</li> </ul>					
LCD controller (LCDC)	<ul style="list-style-type: none"> <li>COM output: 4 (Max)</li> <li>SEG output: 40 (Max)</li> <li>LCD drive power supply (bias) pin: 4 (Max)</li> <li>40 SEG × 4 COM: 160 pixels can be displayed</li> <li>Duty LCD mode</li> <li>Operate in LCD standby mode</li> <li>Blinking function</li> <li>Internal divider resistor for LCD drive</li> </ul>					
16-bit reload timer	1 channel <ul style="list-style-type: none"> <li>Two clock modes and two counter operating modes can be selected</li> <li>Square waveform output</li> <li>Count clock: it can be selected from internal clocks (seven types) and external clocks.</li> <li>Counter operating mode: reload mode or one-shot mode can be selected</li> </ul>					
Event counter	By configuring the 16-bit reload timer and the 8/16-bit composite timer ch. 1, event counter function can be implemented. When the event counter function is used, the 16-bit reload timer and the 8/16-bit composite timer ch. 1 are unavailable.					
8/16-bit PPG	2 channels <ul style="list-style-type: none"> <li>Each channel of the PPG can be used as "8-bit PPG × 2 channels" or "16-bit PPG × 1 channel"</li> <li>Counter operating clock: Eight selectable clock sources</li> </ul>					
Watch counter	<ul style="list-style-type: none"> <li>Count clock: Four selectable clock sources (125 ms, 250 ms, 500 ms or 1 s)</li> <li>Counter value can be set from 0 to 63. (Capable of counting for 1 minute when selecting clock source of 1 second and setting counter value to 60)</li> </ul>					
External interrupt	8 channels <ul style="list-style-type: none"> <li>Interrupt by edge detection (The rising edge, falling edge, or both edges can be selected.)</li> <li>It can be used to wake up the device from the standby mode.</li> </ul>					
On-chip debug	<ul style="list-style-type: none"> <li>1-wire serial control</li> <li>It supports serial writing. (asynchronous mode)</li> </ul>					
Watch prescaler	Eight different time intervals can be selected. (62.5 ms, 125 ms, 250 ms, 500 ms, 1 s, 2 s, 4 s, 8 s)					
Flash memory	<ul style="list-style-type: none"> <li>It supports automatic programming, Embedded Algorithm, program/erase/erase-suspend/erase-resume commands.</li> <li>It has a flag indicating the completion of the operation of Embedded Algorithm.</li> <li>Number of program/erase cycles: 100000</li> <li>Data retention time: 20 years</li> <li>Flash security feature for protecting the content of the Flash memory</li> </ul>					
Standby mode	Sleep mode, stop mode, watch mode, time-base timer mode					
Package	FPT-80P-M37					

# MB95310L/370L Series

• MB95370L Series

Part number	MB95F374E	MB95F376E	MB95F378E	MB95F374L	MB95F376L	MB95F378L
Parameter						
Type	Flash memory product					
Clock supervisor counter	It supervises the main clock oscillation.					
Flash memory capacity	20 Kbyte	36 Kbyte	60 Kbyte	20 Kbyte	36 Kbyte	60 Kbyte
RAM capacity	496 bytes	1008 bytes	2032 bytes	496 bytes	1008 bytes	2032 bytes
Low-voltage detection reset	Yes			No		
Reset input	Dedicated					
CPU functions	<ul style="list-style-type: none"> <li>• Number of basic instructions : 136</li> <li>• Instruction bit length : 8 bits</li> <li>• Instruction length : 1 to 3 bytes</li> <li>• Data bit length : 1, 8 and 16 bits</li> <li>• Minimum instruction execution time : 61.5 ns (machine clock frequency = 16.25 MHz)</li> <li>• Interrupt processing time : 0.6 μs (machine clock frequency = 16.25 MHz)</li> </ul>					
General-purpose I/O	<ul style="list-style-type: none"> <li>• I/O ports (Max): 55</li> <li>• CMOS I/O: 52</li> <li>• N-ch open drain: 3</li> </ul>					
Time-base timer	Interval time: 0.256 ms - 8.3 s (external clock frequency = 4 MHz)					
Hardware/software watchdog timer	<ul style="list-style-type: none"> <li>• Reset generation cycle Main oscillation clock at 10 MHz: 105 ms (Min)</li> <li>• The sub-CR clock can be used as the source clock of the hardware watchdog timer.</li> </ul>					
Wild register	It can be used to replace three bytes of data.					
I <sup>2</sup> C	1 channel					
	<ul style="list-style-type: none"> <li>• Master/Slave sending and receiving</li> <li>• Bus error function and arbitration function</li> <li>• Detecting transmitting direction function</li> <li>• Start condition repeated generation and detection functions</li> <li>• Built-in wake-up function</li> </ul>					
UART/SIO	2 channels					
	<ul style="list-style-type: none"> <li>• Data transfer with UART/SIO is enabled.</li> <li>• It has a full duplex double buffer, variable data length (5/6/7/8 bits), a built-in baud rate generator and an error detection function.</li> <li>• It uses the NRZ type transfer format.</li> <li>• LSB-first data transfer and MSB-first data transfer are available to use.</li> <li>• Clock-asynchronous (UART) serial data transfer and clock-synchronous (SIO) serial data transfer is enabled.</li> </ul>					
8/10-bit A/D converter	4 channels					
	8-bit or 10-bit resolution can be selected.					
8/16-bit composite timer	2 channels					
	<ul style="list-style-type: none"> <li>• Each timer can be configured as an "8-bit timer × 2 channels" or a "16-bit timer × 1 channel".</li> <li>• It has built-in timer function, PWC function, PWM function and input capture function.</li> <li>• Count clock: it can be selected from internal clocks (seven types) and external clocks.</li> <li>• It can output square wave.</li> </ul>					

(Continued)

# MB95310L/370L Series

(Continued)

Part number	MB95F374E	MB95F376E	MB95F378E	MB95F374L	MB95F376L	MB95F378L
Parameter						
LCD controller (LCDC)	<ul style="list-style-type: none"> <li>• COM output: 4 (Max)</li> <li>• SEG output: 32 (Max)</li> <li>• LCD drive power supply (bias) pin: 3 (Max)</li> <li>• 32 SEG × 4 COM: 128 pixels can be displayed</li> </ul>					
	<ul style="list-style-type: none"> <li>• Duty LCD mode</li> <li>• Operate in LCD standby mode</li> <li>• Blinking function</li> <li>• Internal divider resistor for LCD drive</li> </ul>					
16-bit reload timer	1 channel					
	<ul style="list-style-type: none"> <li>• Two clock modes and two counter operating modes can be selected</li> <li>• Square waveform output</li> <li>• Count clock: it can be selected from internal clocks (seven types) and external clocks.</li> <li>• Counter operating mode: reload mode or one-shot mode can be selected</li> </ul>					
Event counter	By configuring the 16-bit reload timer and the 8/16-bit composite timer ch. 1, event counter function can be implemented. When the event counter function is used, the 16-bit reload timer and the 8/16-bit composite timer ch. 1 are unavailable.					
8/16-bit PPG	2 channels					
	<ul style="list-style-type: none"> <li>• Each channel of the PPG can be used as “8-bit PPG × 2 channels” or “16-bit PPG × 1 channel”</li> <li>• Counter operating clock: Eight selectable clock sources</li> </ul>					
Watch counter	<ul style="list-style-type: none"> <li>• Count clock: Four selectable clock sources (125 ms, 250 ms, 500 ms or 1 s)</li> <li>• Counter value can be set from 0 to 63. (Capable of counting for 1 minute when selecting clock source of 1 second and setting counter value to 60)</li> </ul>					
External interrupt	8 channels					
	<ul style="list-style-type: none"> <li>• Interrupt by edge detection (The rising edge, falling edge, or both edges can be selected.)</li> <li>• It can be used to wake up the device from the standby mode.</li> </ul>					
On-chip debug	<ul style="list-style-type: none"> <li>• 1-wire serial control</li> <li>• It supports serial writing. (asynchronous mode)</li> </ul>					
Watch prescaler	Eight different time intervals can be selected. (62.5 ms, 125 ms, 250 ms, 500 ms, 1 s, 2 s, 4 s, 8 s)					
Flash memory	<ul style="list-style-type: none"> <li>• It supports automatic programming, Embedded Algorithm, program/erase/erase-suspend/erase-resume commands.</li> <li>• It has a flag indicating the completion of the operation of Embedded Algorithm.</li> <li>• Number of program/erase cycles: 100000</li> <li>• Data retention time: 20 years</li> <li>• Flash security feature for protecting the content of the Flash memory</li> </ul>					
Standby mode	Sleep mode, stop mode, watch mode, time-base timer mode					
Package	FPT-64P-M38 FPT-64P-M39					

# MB95310L/370L Series

## ■ OSCILLATION STABILIZATION WAIT TIME

The main CR clock oscillation stabilization wait time is fixed to the maximum value. Below is the maximum value.

Oscillation stabilization wait time	Remarks
$(2^{10} - 2) / F_{CRH}$	Approx. 128 $\mu$ s (when the main CR clock is 8 MHz)

The main PLL clock oscillation stabilization wait time is fixed to the maximum value. Below is the maximum value.

Oscillation stabilization wait time	Remarks
$(2^{14} - 2) / F_{CH}$	Approx. 14.1 ms (when the main PLL clock is 4 MHz)

## ■ PACKAGES AND CORRESPONDING PRODUCTS

Part number	MB95F314E	MB95F316E	MB95F318E	MB95F314L	MB95F316L	MB95F318L
<b>Package</b>						
FPT-80P-M37				O		
FPT-64P-M38				X		
FPT-64P-M39				X		

Part number	MB95F374E	MB95F376E	MB95F378E	MB95F374L	MB95F376L	MB95F378L
<b>Package</b>						
FPT-80P-M37				X		
FPT-64P-M38				O		
FPT-64P-M39				O		

O: Available  
X: Unavailable

## ■ DIFFERENCES AMONG PRODUCTS AND NOTES ON PRODUCT SELECTION

- Current consumption

When using the on-chip debug function, take account of the current consumption of flash erase/write.

For details of current consumption, see “■ ELECTRICAL CHARACTERISTICS”.

- Package

For details of information on each package, see “■ PACKAGES AND CORRESPONDING PRODUCTS” and “■ PACKAGE DIMENSION”.

- Operating voltage

The operating voltage varies, depending on whether the on-chip debug function is used or not.

For details of the operating voltage, see “■ ELECTRICAL CHARACTERISTICS”.

- On-chip debug function

The on-chip debug function requires that  $V_{CC}$ ,  $V_{SS}$  and 1 serial-wire be connected to an evaluation tool. For details of the connection method, refer to “CHAPTER 31 EXAMPLE OF SERIAL PROGRAMMING CONNECTION” in the hardware manual of the MB95310L/370L Series.



# MB95310L/370L Series

## PIN ASSIGNMENT

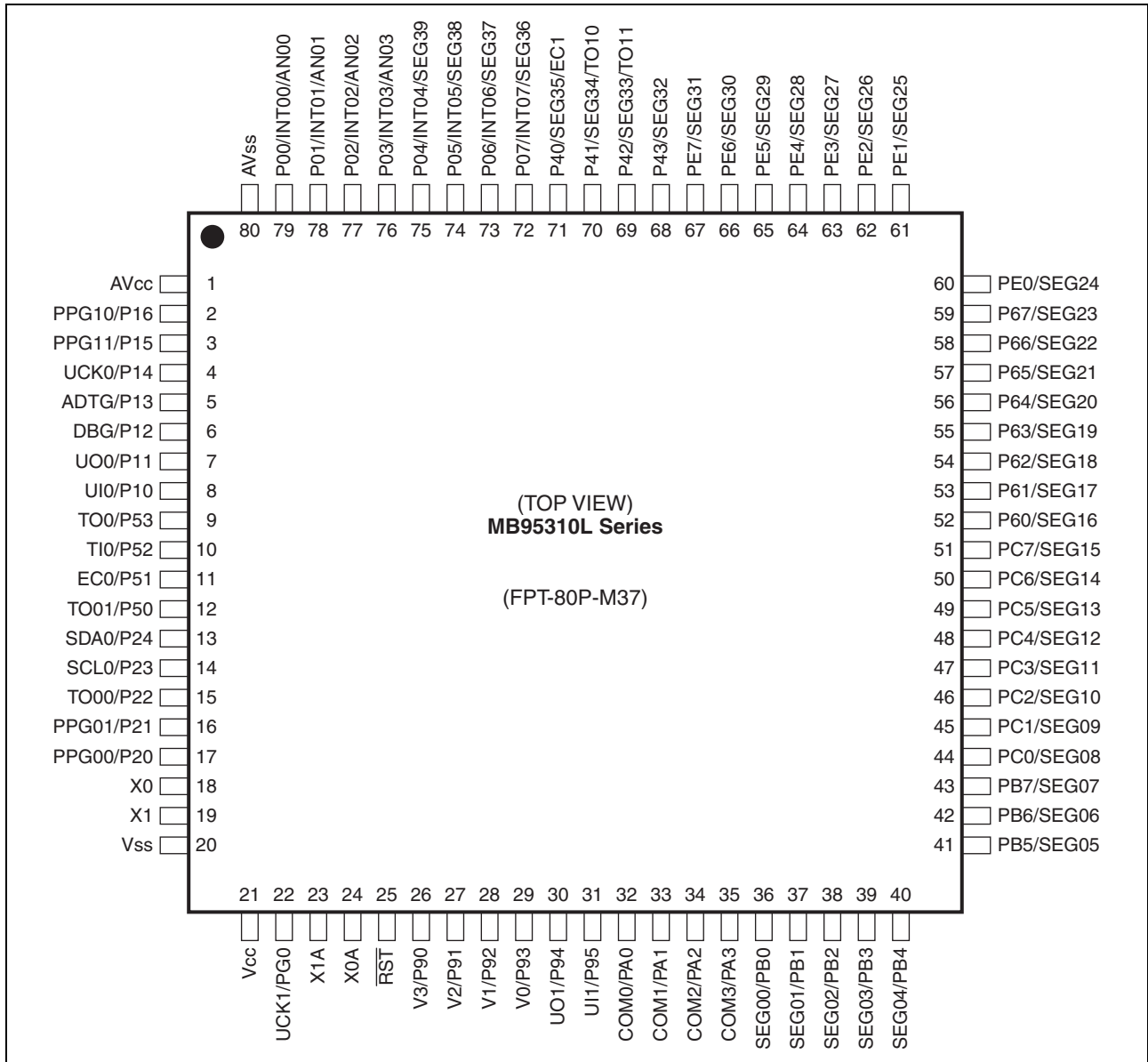

(Continued)

# MB95310L/370L Series

(Continued)

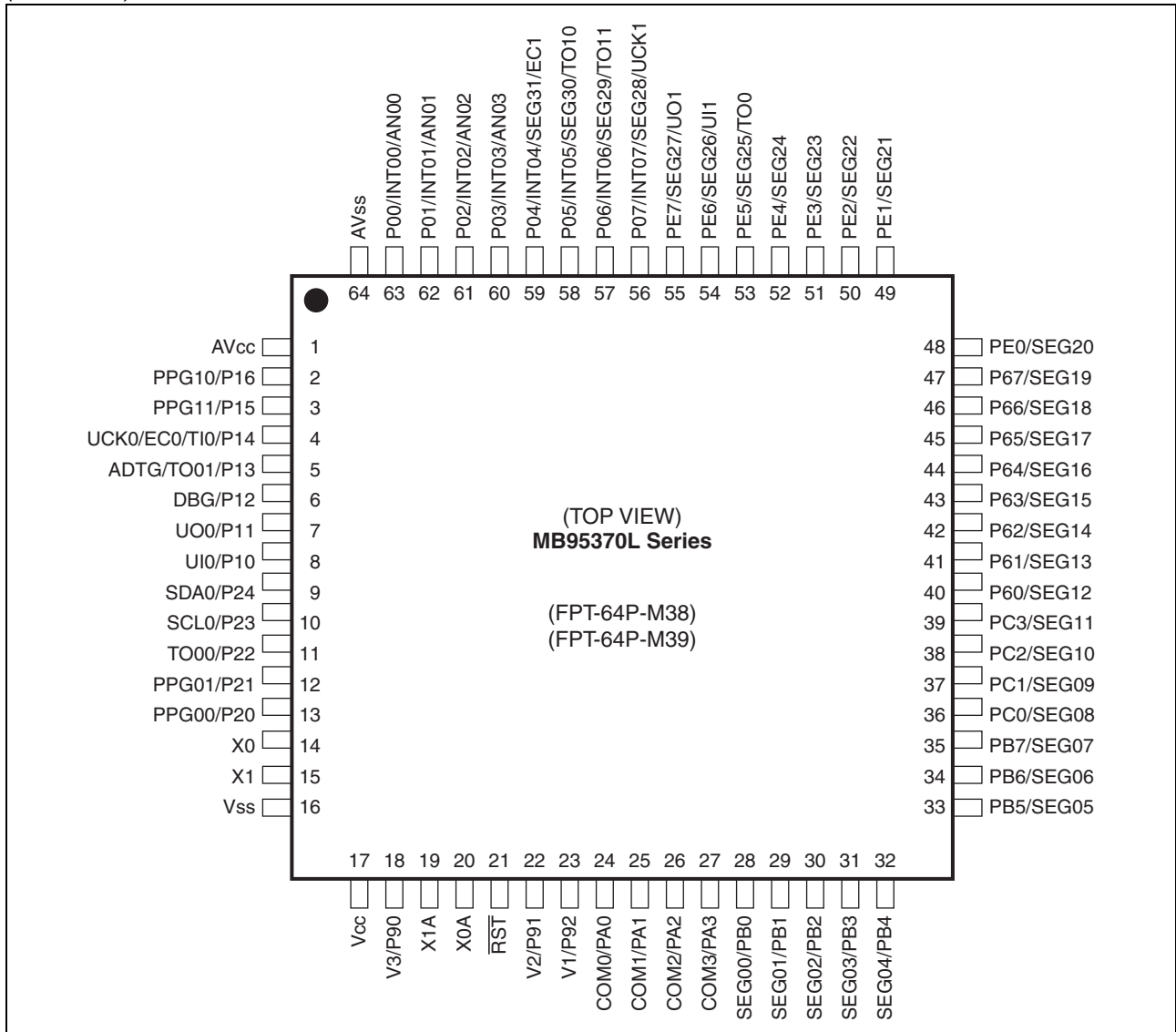

# MB95310L/370L Series

## ■ PIN DESCRIPTION (MB95310L Series)

Pin no.	Pin name	I/O circuit type*	Function
1	AV <sub>cc</sub>	—	A/D converter power supply pin
2	P16	H	General-purpose I/O port
	PPG10		8/16-bit PPG ch. 1 output pin
3	P15	H	General-purpose I/O port
	PPG11		8/16-bit PPG ch. 1 output pin
4	P14	H	General-purpose I/O port
	UCK0		UART/SIO ch. 0 clock I/O pin
5	P13	H	General-purpose I/O port
	ADTG		A/D trigger input (ADTG) pin
6	P12	C	General-purpose I/O port
	DBG		DBG input pin
7	P11	H	General-purpose I/O port
	UO0		UART/SIO ch. 0 data output pin
8	P10	G	General-purpose I/O port
	UI0		UART/SIO ch. 0 data input pin
9	P53	H	General-purpose I/O port
	TO0		16-bit reload timer ch. 0 output pin
10	P52	H	General-purpose I/O port
	TI0		16-bit reload timer ch. 0 input pin The pin can also be used as the event counter input pin when the event counter function is used.
11	P51	H	General-purpose I/O port
	EC0		8/16-bit composite timer ch. 0 clock input pin
12	P50	H	General-purpose I/O port
	TO01		8/16-bit composite timer ch. 0 output pin
13	P24	I	General-purpose I/O port
	SDA0		I <sup>2</sup> C data I/O pin
14	P23	I	General-purpose I/O port
	SCL0		I <sup>2</sup> C clock I/O pin
15	P22	H	General-purpose I/O port
	TO00		8/16-bit composite timer ch. 0 output pin
16	P21	H	General-purpose I/O port
	PPG01		8/16-bit PPG ch. 0 output pin
17	P20	H	General-purpose I/O port
	PPG00		8/16-bit PPG ch. 0 output pin
18	X0	A	Main clock oscillation pin
19	X1	A	Main clock oscillation pin

(Continued)

# MB95310L/370L Series

Pin no.	Pin name	I/O circuit type*	Function
20	V <sub>ss</sub>	—	Power supply pin (GND)
21	V <sub>cc</sub>	—	Power supply pin
22	PG0	H	General-purpose I/O port
	UCK1		UART/SIO ch. 1 clock I/O pin
23	X1A	A	Subclock oscillation pin (32 kHz)
24	X0A	A	Subclock oscillation pin (32 kHz)
25	$\overline{\text{RST}}$	B	Reset pin
26	P90	R	General-purpose I/O port
	V3		LCDC drive power supply pin
27	P91	R	General-purpose I/O port
	V2		LCDC drive power supply pin
28	P92	R	General-purpose I/O port
	V1		LCDC drive power supply pin
29	P93	R	General-purpose I/O port
	V0		LCDC drive power supply pin
30	P94	H	General-purpose I/O port
	UO1		UART/SIO ch. 0 data output pin
31	P95	G	General-purpose I/O port
	UI1		UART/SIO ch. 0 data input pin
32	PA0	M	General-purpose I/O port
	COM0		LCDC COM output pin
33	PA1	M	General-purpose I/O port
	COM1		LCDC COM output pin
34	PA2	M	General-purpose I/O port
	COM2		LCDC COM output pin
35	PA3	M	General-purpose I/O port
	COM3		LCDC COM output pin
36	PB0	M	General-purpose I/O port
	SEG00		LCDC SEG output pin
37	PB1	M	General-purpose I/O port
	SEG01		LCDC SEG output pin
38	PB2	M	General-purpose I/O port
	SEG02		LCDC SEG output pin
39	PB3	M	General-purpose I/O port
	SEG03		LCDC SEG output pin
40	PB4	M	General-purpose I/O port
	SEG04		LCDC SEG output pin

(Continued)

# MB95310L/370L Series

Pin no.	Pin name	I/O circuit type*	Function
41	PB5	M	General-purpose I/O port
	SEG05		LCDC SEG output pin
42	PB6	M	General-purpose I/O port
	SEG06		LCDC SEG output pin
43	PB7	M	General-purpose I/O port
	SEG07		LCDC SEG output pin
44	PC0	M	General-purpose I/O port
	SEG08		LCDC SEG output pin
45	PC1	M	General-purpose I/O port
	SEG09		LCDC SEG output pin
46	PC2	M	General-purpose I/O port
	SEG10		LCDC SEG output pin
47	PC3	M	General-purpose I/O port
	SEG11		LCDC SEG output pin
48	PC4	M	General-purpose I/O port
	SEG12		LCDC SEG output pin
49	PC5	M	General-purpose I/O port
	SEG13		LCDC SEG output pin
50	PC6	M	General-purpose I/O port
	SEG14		LCDC SEG output pin
51	PC7	M	General-purpose I/O port
	SEG15		LCDC SEG output pin
52	P60	M	General-purpose I/O port
	SEG16		LCDC SEG output pin
53	P61	M	General-purpose I/O port
	SEG17		LCDC SEG output pin
54	P62	M	General-purpose I/O port
	SEG18		LCDC SEG output pin
55	P63	M	General-purpose I/O port
	SEG19		LCDC SEG output pin
56	P64	M	General-purpose I/O port
	SEG20		LCDC SEG output pin
57	P65	M	General-purpose I/O port
	SEG21		LCDC SEG output pin
58	P66	M	General-purpose I/O port
	SEG22		LCDC SEG output pin

(Continued)

# MB95310L/370L Series

Pin no.	Pin name	I/O circuit type*	Function
59	P67	M	General-purpose I/O port
	SEG23		LCDC SEG output pin
60	PE0	M	General-purpose I/O port
	SEG24		LCDC SEG output pin
61	PE1	M	General-purpose I/O port
	SEG25		LCDC SEG output pin
62	PE2	M	General-purpose I/O port
	SEG26		LCDC SEG output pin
63	PE3	M	General-purpose I/O port
	SEG27		LCDC SEG output pin
64	PE4	M	General-purpose I/O port
	SEG28		LCDC SEG output pin
65	PE5	M	General-purpose I/O port
	SEG29		LCDC SEG output pin
66	PE6	N	General-purpose I/O port
	SEG30		LCDC SEG output pin
67	PE7	M	General-purpose I/O port
	SEG31		LCDC SEG output pin
68	P43	M	General-purpose I/O port
	SEG32		LCDC SEG output pin
69	P42	M	General-purpose I/O port
	SEG33		LCDC SEG output pin
	TO11		8/16-bit composite timer ch. 1 output pin
70	P41	M	General-purpose I/O port
	SEG34		LCDC SEG output pin
	TO10		8/16-bit composite timer ch. 1 output pin
71	P40	M	General-purpose I/O port
	SEG35		LCDC SEG output pin
	EC1		8/16-bit composite timer ch. 1 clock input pin
72	P07	Q	General-purpose I/O port
	INT07		External interrupt input pin
	SEG36		LCDC SEG output pin
73	P06	Q	General-purpose I/O port
	INT06		External interrupt input pin
	SEG37		LCDC SEG output pin

(Continued)

# MB95310L/370L Series

(Continued)

Pin no.	Pin name	I/O circuit type*	Function
74	P05	Q	General-purpose I/O port
	INT05		External interrupt input pin
	SEG38		LCDC SEG output pin
75	P04	Q	General-purpose I/O port
	INT04		External interrupt input pin
	SEG39		LCDC SEG output pin
76	P03	J	General-purpose I/O port
	INT03		External interrupt input pin
	AN03		A/D analog input pin
77	P02	J	General-purpose I/O port
	INT02		External interrupt input pin
	AN02		A/D analog input pin
78	P01	J	General-purpose I/O port
	INT01		External interrupt input pin
	AN01		A/D analog input pin
79	P00	J	General-purpose I/O port
	INT00		External interrupt input pin
	AN00		A/D analog input pin
80	AV <sub>ss</sub>	—	A/D converter power supply pin (GND)

\*: For the I/O circuit types, see “■ I/O CIRCUIT TYPE”.

# MB95310L/370L Series

## ■ PIN DESCRIPTION (MB95370L Series)

Pin no.	Pin name	I/O circuit type*	Function
1	AV <sub>cc</sub>	—	A/D converter power supply pin
2	P16	H	General-purpose I/O port
	PPG10		8/16-bit PPG ch. 1 output pin
3	P15	H	General-purpose I/O port
	PPG11		8/16-bit PPG ch. 1 output pin
4	P14	H	General-purpose I/O port
	UCK0		UART/SIO ch. 0 clock I/O pin
	EC0		8/16-bit composite timer ch. 0 clock input pin The pin can also be used as the event counter input pin when the event counter function is used.
	TI0		16-bit reload timer ch. 0 input pin
5	P13	H	General-purpose I/O port
	ADTG		A/D trigger input (ADTG) pin
	TO01		8/16-bit composite timer ch. 0 output pin
6	P12	C	General-purpose I/O port
	DBG		DBG input pin
7	P11	H	General-purpose I/O port
	UO0		UART/SIO ch. 0 data output pin
8	P10	G	General-purpose I/O port
	UI0		UART/SIO ch. 0 data input pin
9	P24	I	General-purpose I/O port
	SDA0		I <sup>2</sup> C data I/O pin
10	P23	I	General-purpose I/O port
	SCL0		I <sup>2</sup> C clock I/O pin
11	P22	H	General-purpose I/O port
	TO00		8/16-bit composite timer ch. 0 output pin
12	P21	H	General-purpose I/O port
	PPG01		8/16-bit PPG ch. 0 output pin
13	P20	H	General-purpose I/O port
	PPG00		8/16-bit PPG ch. 0 output pin
14	X0	A	Main clock oscillation pin
15	X1	A	Main clock oscillation pin
16	V <sub>ss</sub>	—	Power supply pin (GND)
17	V <sub>cc</sub>	—	Power supply pin
18	P90	R	General-purpose I/O port
	V3		LCDC drive power supply pin

(Continued)



# MB95310L/370L Series

Pin no.	Pin name	I/O circuit type*	Function
19	X1A	A	Subclock oscillation pin (32 kHz)
20	X0A		Subclock oscillation pin (32 kHz)
21	$\overline{RST}$	B	Reset pin
22	P91	R	General-purpose I/O port
	V2		LCDC drive power supply pin
23	P92	R	General-purpose I/O port
	V1		LCDC drive power supply pin
24	PA0	M	General-purpose I/O port
	COM0		LCDC COM output pin
25	PA1	M	General-purpose I/O port
	COM1		LCDC COM output pin
26	PA2	M	General-purpose I/O port
	COM2		LCDC COM output pin
27	PA3	M	General-purpose I/O port
	COM3		LCDC COM output pin
28	PB0	M	General-purpose I/O port
	SEG00		LCDC SEG output pin
29	PB1	M	General-purpose I/O port
	SEG01		LCDC SEG output pin
30	PB2	M	General-purpose I/O port
	SEG02		LCDC SEG output pin
31	PB3	M	General-purpose I/O port
	SEG03		LCDC SEG output pin
32	PB4	M	General-purpose I/O port
	SEG04		LCDC SEG output pin
33	PB5	M	General-purpose I/O port
	SEG05		LCDC SEG output pin
34	PB6	M	General-purpose I/O port
	SEG06		LCDC SEG output pin
35	PB7	M	General-purpose I/O port
	SEG07		LCDC SEG output pin
36	PC0	M	General-purpose I/O port
	SEG08		LCDC SEG output pin
37	PC1	M	General-purpose I/O port
	SEG09		LCDC SEG output pin
38	PC2	M	General-purpose I/O port
	SEG10		LCDC SEG output pin

(Continued)

# MB95310L/370L Series

Pin no.	Pin name	I/O circuit type*	Function
39	PC3	M	General-purpose I/O port
	SEG11		LCDC SEG output pin
40	P60	M	General-purpose I/O port
	SEG12		LCDC SEG output pin
41	P61	M	General-purpose I/O port
	SEG13		LCDC SEG output pin
42	P62	M	General-purpose I/O port
	SEG14		LCDC SEG output pin
43	P63	M	General-purpose I/O port
	SEG15		LCDC SEG output pin
44	P64	M	General-purpose I/O port
	SEG16		LCDC SEG output pin
45	P65	M	General-purpose I/O port
	SEG17		LCDC SEG output pin
46	P66	M	General-purpose I/O port
	SEG18		LCDC SEG output pin
47	P67	M	General-purpose I/O port
	SEG19		LCDC SEG output pin
48	PE0	M	General-purpose I/O port
	SEG20		LCDC SEG output pin
49	PE1	M	General-purpose I/O port
	SEG21		LCDC SEG output pin
50	PE2	M	General-purpose I/O port
	SEG22		LCDC SEG output pin
51	PE3	M	General-purpose I/O port
	SEG23		LCDC SEG output pin
52	PE4	M	General-purpose I/O port
	SEG24		LCDC SEG output pin
53	PE5	M	General-purpose I/O port
	SEG25		LCDC SEG output pin
	TO0		16-bit reload timer ch. 0 output pin
54	PE6	N	General-purpose I/O port
	SEG26		LCDC SEG output pin
	UI1		UART/SIO ch. 1 data input pin
55	PE7	M	General-purpose I/O port
	SEG27		LCDC SEG output pin
	UO1		UART/SIO ch. 1 data output pin

(Continued)

# MB95310L/370L Series

(Continued)

Pin no.	Pin name	I/O circuit type*	Function
56	P07	Q	General-purpose I/O port
	INT07		External interrupt input pin
	SEG28		LCDC SEG output pin
	UCK1		UART/SIO ch. 1 clock I/O pin
57	P06	Q	General-purpose I/O port
	INT06		External interrupt input pin
	SEG29		LCDC SEG output pin
	TO11		8/16-bit composite timer ch. 1 output pin
58	P05	Q	General-purpose I/O port
	INT05		External interrupt input pin
	SEG30		LCDC SEG output pin
	TO10		8/16-bit composite timer ch. 1 output pin
59	P04	Q	General-purpose I/O port
	INT04		External interrupt input pin
	SEG31		LCDC SEG output pin
	EC1		8/16-bit composite timer ch. 1 clock input pin
60	P03	J	General-purpose I/O port
	INT03		External interrupt input pin
	AN03		A/D analog input pin
61	P02	J	General-purpose I/O port
	INT02		External interrupt input pin
	AN02		A/D analog input pin
62	P01	J	General-purpose I/O port
	INT01		External interrupt input pin
	AN01		A/D analog input pin
63	P00	J	General-purpose I/O port
	INT00		External interrupt input pin
	AN00		A/D analog input pin
64	AV <sub>ss</sub>	—	A/D converter power supply pin (GND)

\*: For the I/O circuit types, see “■ I/O CIRCUIT TYPE”.

# MB95310L/370L Series

## ■ I/O CIRCUIT TYPE

Type	Circuit	Remarks
A		<ul style="list-style-type: none"> <li>• Oscillation circuit</li> <li>• High-speed side Feedback resistance: approx. 1 MΩ</li> <li>• Low-speed side Feedback resistance: approx. 24 MΩ Dumping resistance: approx. 144 kΩ</li> </ul>
B		Reset input
C		<ul style="list-style-type: none"> <li>• N-ch open drain output</li> <li>• Hysteresis input</li> </ul>
G		<ul style="list-style-type: none"> <li>• CMOS output</li> <li>• Hysteresis input</li> <li>• CMOS input</li> <li>• Pull-up control available</li> </ul>
H		<ul style="list-style-type: none"> <li>• CMOS output</li> <li>• Hysteresis input</li> <li>• Pull-up control available</li> </ul>

(Continued)

# MB95310L/370L Series

Type	Circuit	Remarks
I	<p>Standby control CMOS input Hysteresis input Digital output N-ch</p>	<ul style="list-style-type: none"> <li>• N-ch open drain output</li> <li>• CMOS input</li> <li>• Hysteresis input</li> </ul>
J	<p>Pull-up control Digital output Digital output Analog input A/D control Standby control Hysteresis input R P-ch N-ch</p>	<ul style="list-style-type: none"> <li>• CMOS output</li> <li>• Hysteresis input</li> <li>• Analog input</li> <li>• Pull-up control available</li> </ul>
M	<p>Digital output Digital output LCD output LCD control Standby control Hysteresis input P-ch N-ch</p>	<ul style="list-style-type: none"> <li>• CMOS output</li> <li>• LCD output</li> <li>• Hysteresis input</li> </ul>
N	<p>Digital output Digital output LCD output LCD control Standby control Hysteresis input CMOS input P-ch N-ch</p>	<ul style="list-style-type: none"> <li>• CMOS output</li> <li>• LCD output</li> <li>• Hysteresis input</li> <li>• CMOS input</li> </ul>

(Continued)

# MB95310L/370L Series

(Continued)

Type	Circuit	Remarks
Q		<ul style="list-style-type: none"> <li>• CMOS output</li> <li>• LCD output</li> <li>• Hysteresis input</li> </ul>
R		<ul style="list-style-type: none"> <li>• CMOS output</li> <li>• LCD power supply</li> <li>• Hysteresis input</li> </ul>

## ■ NOTES ON DEVICE HANDLING

- Preventing latch-ups

When using the device, ensure that the voltage applied does not exceed the maximum voltage rating.

In a CMOS IC, if a voltage higher than  $V_{CC}$  or a voltage lower than  $V_{SS}$  is applied to an input/output pin that is neither a medium-withstand voltage pin nor a high-withstand voltage pin, or if a voltage out of the rating range of power supply voltage mentioned in “1. Absolute Maximum Ratings” of “■ ELECTRICAL CHARACTERISTICS” is applied to the  $V_{CC}$  pin or the  $V_{SS}$  pin, a latch-up may occur.

When a latch-up occurs, power supply current increases significantly, which may cause a component to be thermally destroyed.

- Stabilizing supply voltage

Supply voltage must be stabilized.

A malfunction may occur when power supply voltage fluctuates rapidly even though the fluctuation is within the guaranteed operating range of the  $V_{CC}$  power supply voltage.

As a rule of voltage stabilization, suppress voltage fluctuation so that the fluctuation in  $V_{CC}$  ripple (p-p value) at the commercial frequency (50 Hz/60 Hz) does not exceed 10% of the standard  $V_{CC}$  value, and the transient fluctuation rate does not exceed 0.1 V/ms at a momentary fluctuation such as switching the power supply.

- Notes on using the external clock

When an external clock is used, oscillation stabilization wait time is required for power-on reset, wake-up from subclock mode or stop mode.

## ■ PIN CONNECTION

- Treatment of unused input pins

If an unused input pin is left unconnected, a component may be permanently damaged due to malfunctions or latch-ups. Always pull up or pull down an unused input pin through a resistor of at least 2 k $\Omega$ . Set an unused input/output pin to the output state and leave it unconnected, or set it to the input state and treat it the same as an unused input pin. If there is an unused output pin, leave it unconnected.

- Notes on handling the external clock pins while using the CR clock

Connect the X0 pin and the X0A pin to the  $V_{SS}$  pin and leave the X1 pin and the X1A pin unconnected.

- Power supply pins

To reduce unnecessary electro-magnetic emission, prevent malfunctions of strobe signals due to an increase in the ground level, and conform to the total output current standard, always connect the  $V_{CC}$  pin and the  $V_{SS}$  pin to the power supply and ground outside the device. In addition, connect the current supply source to the  $V_{CC}$  pin and the  $V_{SS}$  pin with low impedance.

It is also advisable to connect a ceramic capacitor of approximately 0.1  $\mu\text{F}$  as a bypass capacitor between the  $V_{CC}$  pin and the  $V_{SS}$  pin at a location close to this device.

- DBG pin

Connect the DBG pin directly to an external pull-up resistor.

To prevent the device from unintentionally entering the debug mode due to noise, minimize the distance between the DBG pin and the  $V_{CC}$  or  $V_{SS}$  pin when designing the layout of the printed circuit board.

The DBG pin should not stay at “L” level after power-on until the reset output is released.

- $\overline{\text{RST}}$  pin

Connect the  $\overline{\text{RST}}$  pin directly to an external pull-up resistor.

To prevent the device from unintentionally entering the reset mode due to noise, minimize the distance between the  $\overline{\text{RST}}$  pin and the  $V_{CC}$  or  $V_{SS}$  pin when designing the layout of the printed circuit board.

# MB95310L/370L Series

- DBG/ $\overline{\text{RST}}$  pins connection diagram

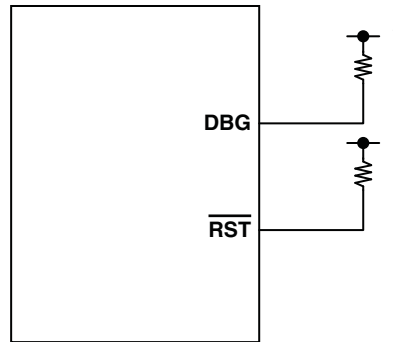

\*: Since the DBG input pin becomes a communication pin in on-chip debug mode, set a pull-up resistor value suiting the input/output specifications of P12/DBG.



## ■ RECOMMENDED LAYOUT

- GND wire should be placed around X0, X1, X0A and X1A  
The recommended layout method illustrated in following diagram aims to avoid noise coupled between the oscillator pins and GPIO, which may cause the main oscillator or the suboscillator to malfunction.

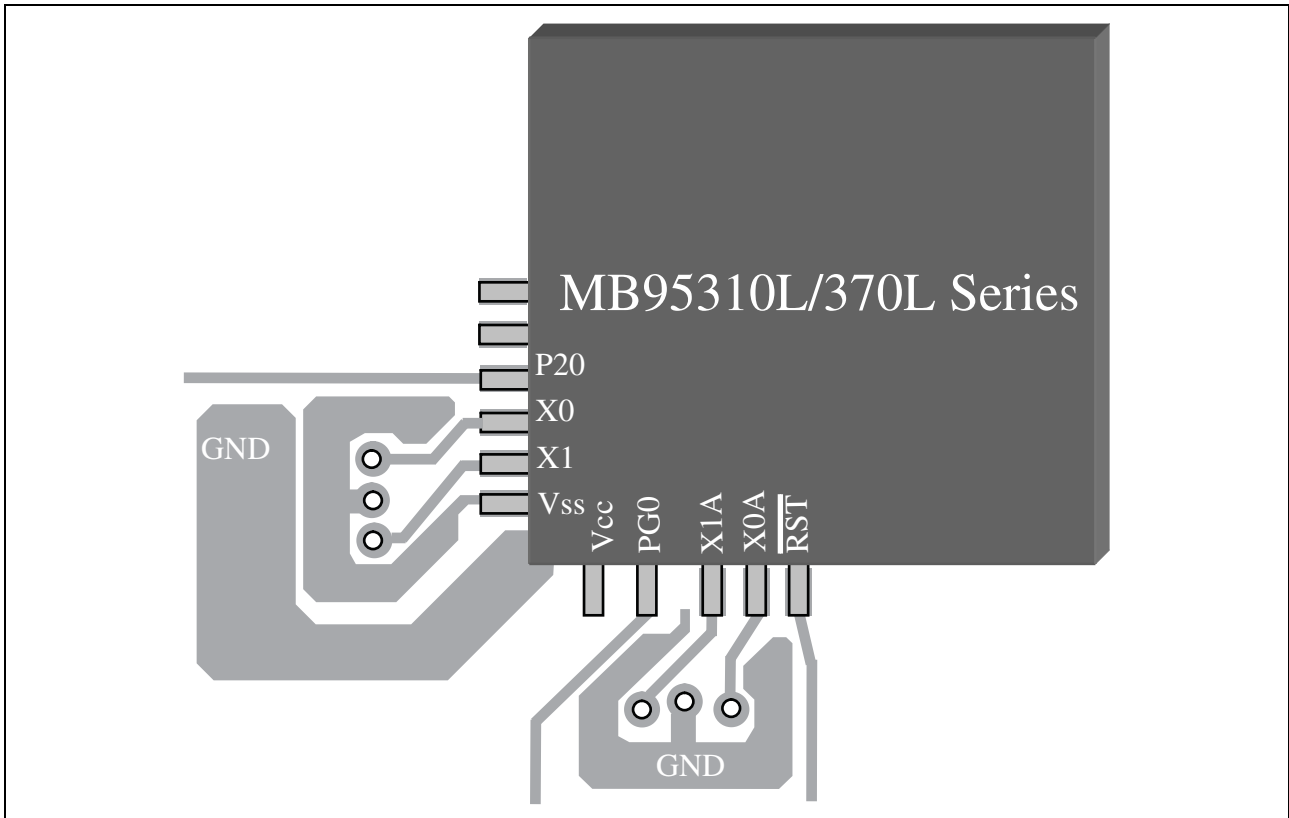

# MB95310L/370L Series

## ■ BLOCK DIAGRAM (MB95310L Series)

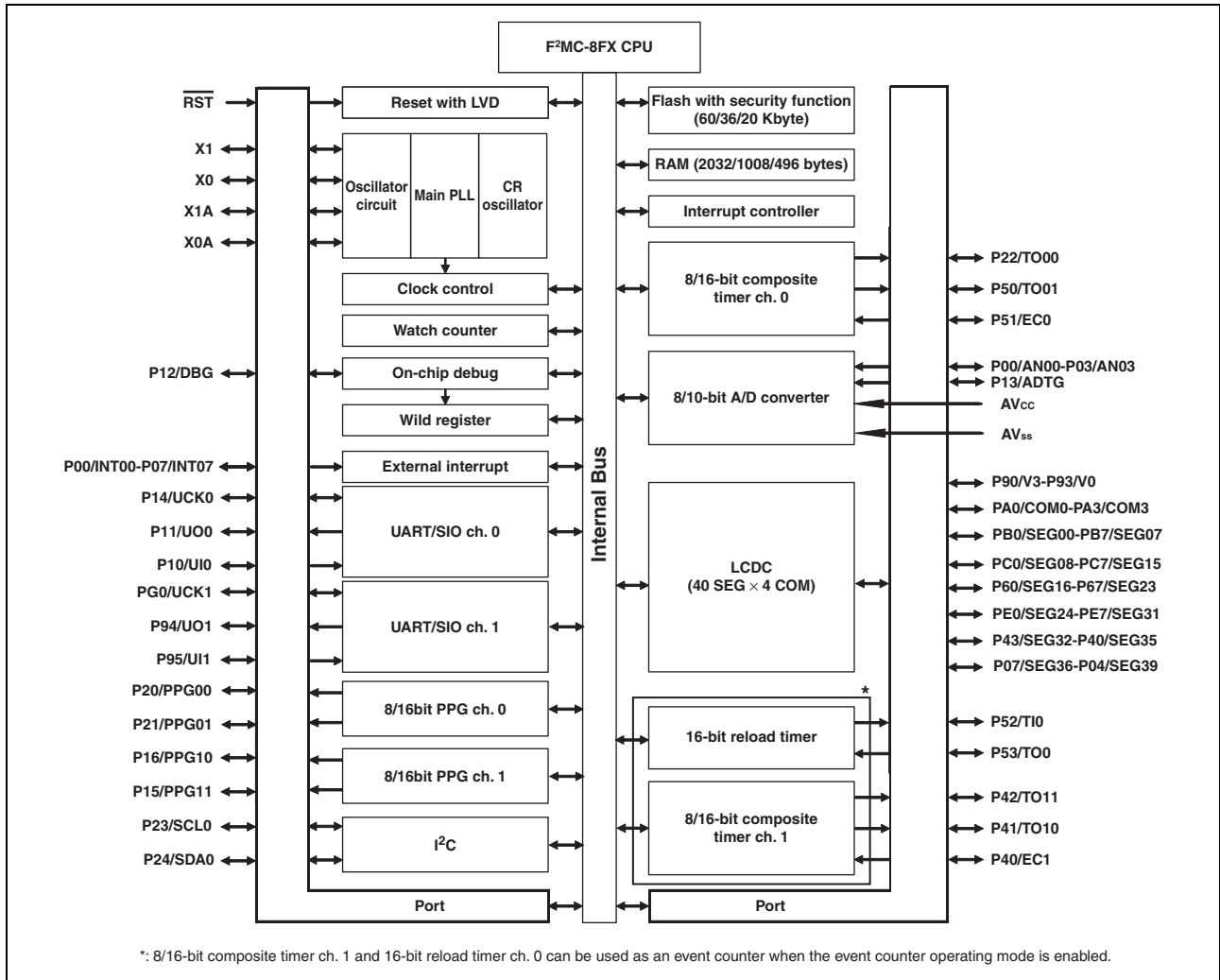

## ■ BLOCK DIAGRAM (MB95370L Series)

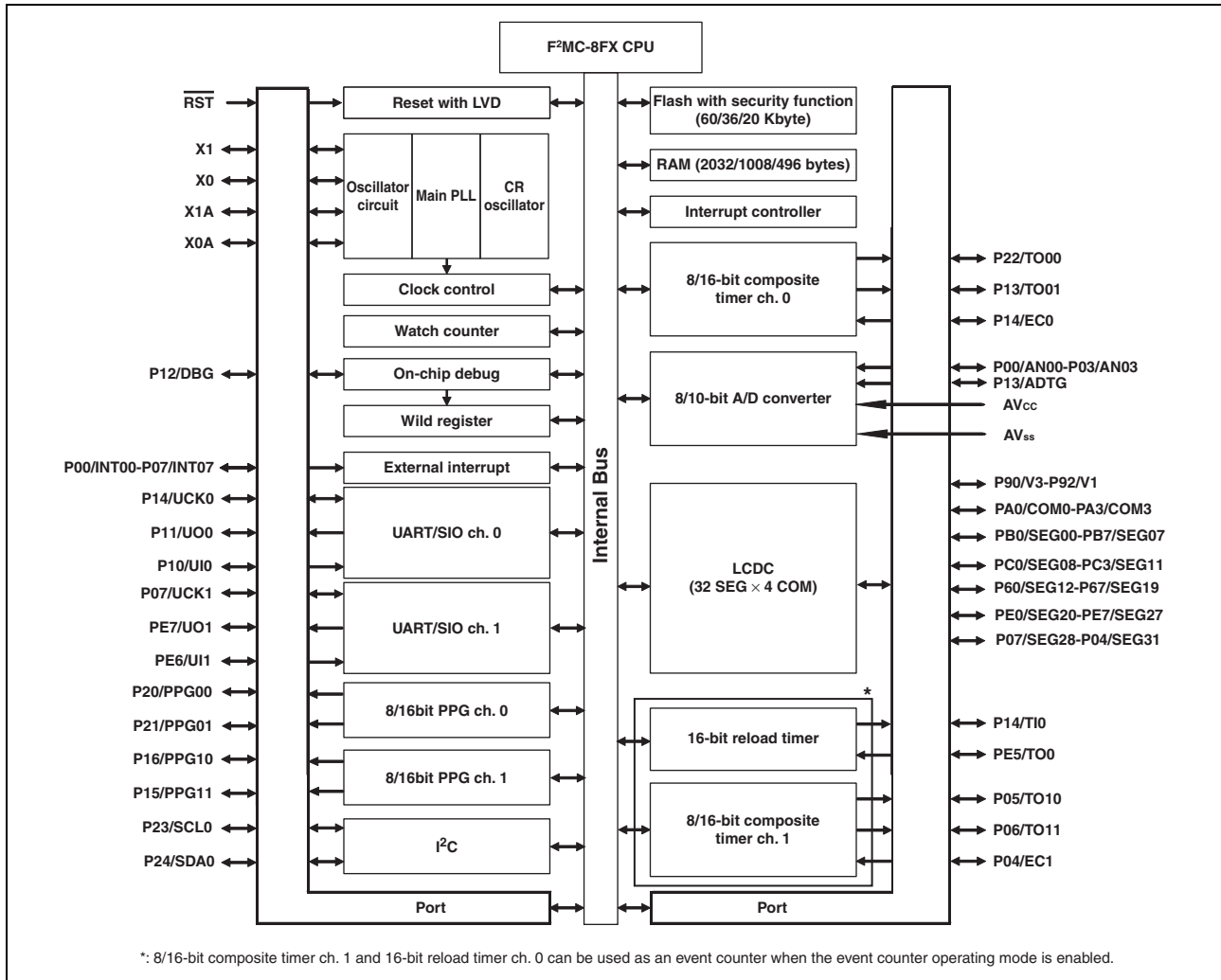

# MB95310L/370L Series

## ■ CPU CORE

### • Memory Space

The memory space of the MB95310L/370L Series is 64 Kbyte in size, and consists of an I/O area, a data area, and a program area. The memory space includes areas intended for specific purposes such as general-purpose registers and a vector table. The memory maps of the MB95310L/370L Series are shown below.

### • Memory Maps

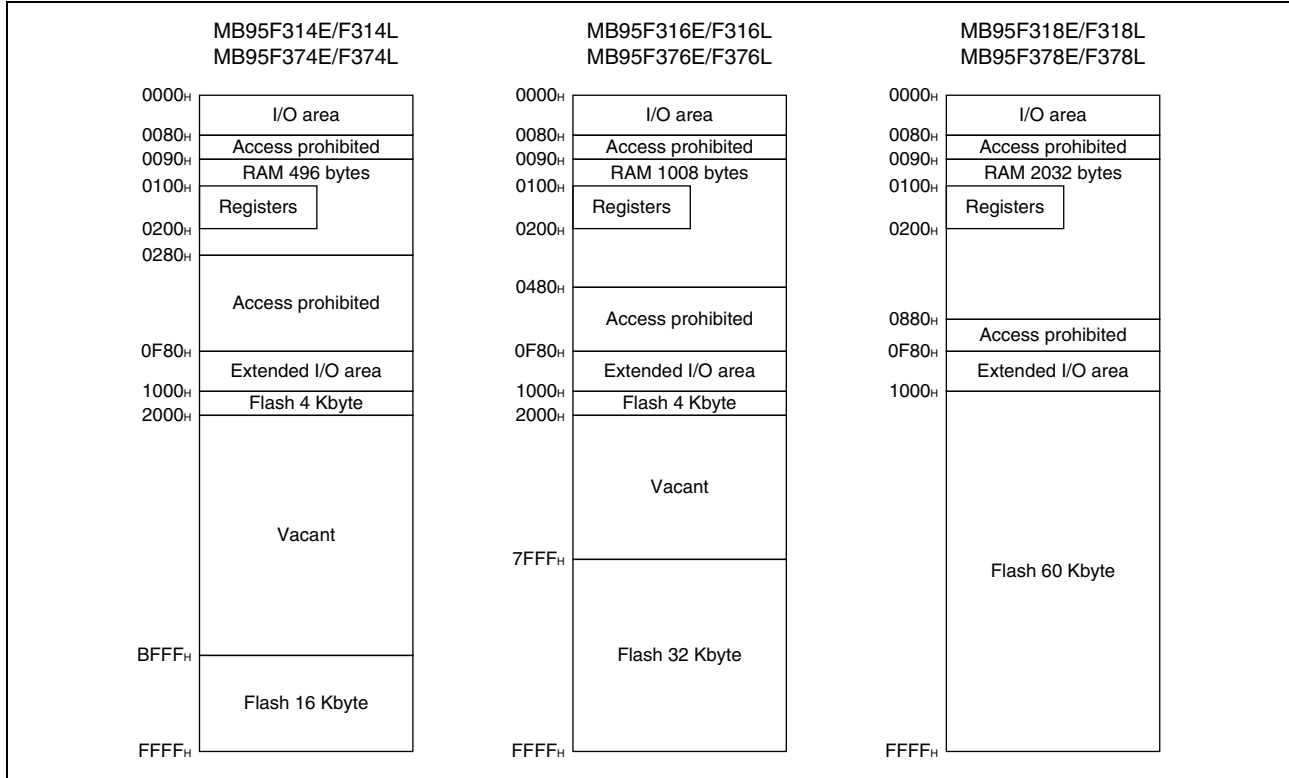

# MB95310L/370L Series

## ■ I/O MAP (MB95310L Series)

Address	Register abbreviation	Register name	R/W	Initial value
0000 <sub>H</sub>	PDR0	Port 0 data register	R/W	00000000 <sub>B</sub>
0001 <sub>H</sub>	DDR0	Port 0 direction register	R/W	00000000 <sub>B</sub>
0002 <sub>H</sub>	PDR1	Port 1 data register	R/W	00000000 <sub>B</sub>
0003 <sub>H</sub>	DDR1	Port 1 direction register	R/W	00000000 <sub>B</sub>
0004 <sub>H</sub>	—	(Disabled)	—	—
0005 <sub>H</sub>	WATR	Oscillation stabilization wait time setting register	R/W	11111111 <sub>B</sub>
0006 <sub>H</sub>	PLLC	PLL control register	R/W	00000000 <sub>B</sub>
0007 <sub>H</sub>	SYCC	System clock control register	R/W	XXXXXX11 <sub>B</sub>
0008 <sub>H</sub>	STBC	Standby control register	R/W	0000XXX <sub>B</sub>
0009 <sub>H</sub>	RSRR	Reset source register	R/W	000XXXX <sub>B</sub>
000A <sub>H</sub>	TBTC	Time-base timer control register	R/W	00000000 <sub>B</sub>
000B <sub>H</sub>	WPCR	Watch prescaler control register	R/W	00000000 <sub>B</sub>
000C <sub>H</sub>	WDTC	Watchdog timer control register	R/W	00000000 <sub>B</sub>
000D <sub>H</sub>	SYCC2	System clock control register 2	R/W	XX100011 <sub>B</sub>
000E <sub>H</sub>	PDR2	Port 2 data register	R/W	00000000 <sub>B</sub>
000F <sub>H</sub>	DDR2	Port 2 direction register	R/W	00000000 <sub>B</sub>
0010 <sub>H</sub> , 0011 <sub>H</sub>	—	(Disabled)	—	—
0012 <sub>H</sub>	PDR4	Port 4 data register	R/W	00000000 <sub>B</sub>
0013 <sub>H</sub>	DDR4	Port 4 direction register	R/W	00000000 <sub>B</sub>
0014 <sub>H</sub>	PDR5	Port 5 data register	R/W	00000000 <sub>B</sub>
0015 <sub>H</sub>	DDR5	Port 5 direction register	R/W	00000000 <sub>B</sub>
0016 <sub>H</sub>	PDR6	Port 6 data register	R/W	00000000 <sub>B</sub>
0017 <sub>H</sub>	DDR6	Port 6 direction register	R/W	00000000 <sub>B</sub>
0018 <sub>H</sub> to 001B <sub>H</sub>	—	(Disabled)	—	—
001C <sub>H</sub>	PDR9	Port 9 data register	R/W	00000000 <sub>B</sub>
001D <sub>H</sub>	DDR9	Port 9 direction register	R/W	00000000 <sub>B</sub>
001E <sub>H</sub>	PDRA	Port A data register	R/W	00000000 <sub>B</sub>
001F <sub>H</sub>	DDRA	Port A direction register	R/W	00000000 <sub>B</sub>
0020 <sub>H</sub>	PDRB	Port B data register	R/W	00000000 <sub>B</sub>
0021 <sub>H</sub>	DDRB	Port B direction register	R/W	00000000 <sub>B</sub>
0022 <sub>H</sub>	PDRC	Port C data register	R/W	00000000 <sub>B</sub>
0023 <sub>H</sub>	DDRC	Port C direction register	R/W	00000000 <sub>B</sub>
0024 <sub>H</sub> , 0025 <sub>H</sub>	—	(Disabled)	—	—

(Continued)

# MB95310L/370L Series

Address	Register abbreviation	Register name	R/W	Initial value
0026 <sub>H</sub>	PDRE	Port E data register	R/W	00000000 <sub>B</sub>
0027 <sub>H</sub>	DDRE	Port E direction register	R/W	00000000 <sub>B</sub>
0028 <sub>H</sub> , 0029 <sub>H</sub>	—	(Disabled)	—	—
002A <sub>H</sub>	PDRG	Port G data register	R/W	00000000 <sub>B</sub>
002B <sub>H</sub>	DDRG	Port G direction register	R/W	00000000 <sub>B</sub>
002C <sub>H</sub>	PUL0	Port 0 pull-up register	R/W	00000000 <sub>B</sub>
002D <sub>H</sub>	PUL1	Port 1 pull-up register	R/W	00000000 <sub>B</sub>
002E <sub>H</sub>	PUL2	Port 2 pull-up register	R/W	00000000 <sub>B</sub>
002F <sub>H</sub> , 0030 <sub>H</sub>	—	(Disabled)	—	—
0031 <sub>H</sub>	PUL5	Port 5 pull-up register	R/W	00000000 <sub>B</sub>
0032 <sub>H</sub> , 0033 <sub>H</sub>	—	(Disabled)	—	—
0034 <sub>H</sub>	PUL9	Port 9 pull-up register	R/W	00000000 <sub>B</sub>
0035 <sub>H</sub>	PULG	Port G pull-up register	R/W	00000000 <sub>B</sub>
0036 <sub>H</sub>	T01CR1	8/16-bit composite timer 01 status control register 1 ch. 0	R/W	00000000 <sub>B</sub>
0037 <sub>H</sub>	T00CR1	8/16-bit composite timer 00 status control register 1 ch. 0	R/W	00000000 <sub>B</sub>
0038 <sub>H</sub>	T11CR1	8/16-bit composite timer 11 status control register 1 ch. 1	R/W	00000000 <sub>B</sub>
0039 <sub>H</sub>	T10CR1	8/16-bit composite timer 10 status control register 1 ch. 1	R/W	00000000 <sub>B</sub>
003A <sub>H</sub>	PC01	8/16-bit PPG01 control register ch. 0	R/W	00000000 <sub>B</sub>
003B <sub>H</sub>	PC00	8/16-bit PPG00 control register ch. 0	R/W	00000000 <sub>B</sub>
003C <sub>H</sub>	PC11	8/16-bit PPG11 control register ch. 1	R/W	00000000 <sub>B</sub>
003D <sub>H</sub>	PC10	8/16-bit PPG10 control register ch. 1	R/W	00000000 <sub>B</sub>
003E <sub>H</sub>	TMCSRH	16-bit reload timer control status register upper ch. 0	R/W	00000000 <sub>B</sub>
003F <sub>H</sub>	TMCSRL	16-bit reload timer control status register lower ch. 0	R/W	00000000 <sub>B</sub>
0040 <sub>H</sub> to 0047 <sub>H</sub>	—	(Disabled)	—	—
0048 <sub>H</sub>	EIC00	External interrupt circuit control register ch. 0/ch. 1	R/W	00000000 <sub>B</sub>
0049 <sub>H</sub>	EIC10	External interrupt circuit control register ch. 2/ch. 3	R/W	00000000 <sub>B</sub>
004A <sub>H</sub>	EIC20	External interrupt circuit control register ch. 4/ch. 5	R/W	00000000 <sub>B</sub>
004B <sub>H</sub>	EIC30	External interrupt circuit control register ch. 6/ch. 7	R/W	00000000 <sub>B</sub>
004C <sub>H</sub> , 004D <sub>H</sub>	—	(Disabled)	—	—
004E <sub>H</sub>	LVDR	LVD reset voltage selection ID register	R/W	00000000 <sub>B</sub>
004F <sub>H</sub>	LVDC	LVD control register	R/W	X000000X <sub>B</sub>
0050 <sub>H</sub> to 0055 <sub>H</sub>	—	(Disabled)	—	—

(Continued)

# MB95310L/370L Series

Address	Register abbreviation	Register name	R/W	Initial value
0056 <sub>H</sub>	SMC10	UART/SIO serial mode control register 1 ch. 0	R/W	00000000 <sub>B</sub>
0057 <sub>H</sub>	SMC20	UART/SIO serial mode control register 2 ch. 0	R/W	00100000 <sub>B</sub>
0058 <sub>H</sub>	SSR0	UART/SIO serial status register ch. 0	R/W	00000001 <sub>B</sub>
0059 <sub>H</sub>	TDR0	UART/SIO output data register ch. 0	R/W	00000000 <sub>B</sub>
005A <sub>H</sub>	RDR0	UART/SIO input data register ch. 0	R	00000000 <sub>B</sub>
005B <sub>H</sub>	SMC11	UART/SIO serial mode control register 1 ch. 1	R/W	00000000 <sub>B</sub>
005C <sub>H</sub>	SMC21	UART/SIO serial mode control register 2 ch. 1	R/W	00100000 <sub>B</sub>
005D <sub>H</sub>	SSR1	UART/SIO serial status register ch. 1	R/W	00000001 <sub>B</sub>
005E <sub>H</sub>	TDR1	UART/SIO output data register ch. 1	R/W	00000000 <sub>B</sub>
005F <sub>H</sub>	RDR1	UART/SIO input data register ch. 1	R	00000000 <sub>B</sub>
0060 <sub>H</sub>	IBCR00	I <sup>2</sup> C bus control register 0	R/W	00000001 <sub>B</sub>
0061 <sub>H</sub>	IBCR10	I <sup>2</sup> C bus control register 1	R/W	00000000 <sub>B</sub>
0062 <sub>H</sub>	IBCR0	I <sup>2</sup> C bus status register	R	00000000 <sub>B</sub>
0063 <sub>H</sub>	IDDR0	I <sup>2</sup> C data register	R/W	00000000 <sub>B</sub>
0064 <sub>H</sub>	IAAR0	I <sup>2</sup> C address register	R/W	00000000 <sub>B</sub>
0065 <sub>H</sub>	ICCR0	I <sup>2</sup> C clock control register	R/W	00000000 <sub>B</sub>
0066 <sub>H</sub> to 006B <sub>H</sub>	—	(Disabled)	—	—
006C <sub>H</sub>	ADC1	8/10-bit A/D converter control register 1	R/W	00000000 <sub>B</sub>
006D <sub>H</sub>	ADC2	8/10-bit A/D converter control register 2	R/W	00000000 <sub>B</sub>
006E <sub>H</sub>	ADDH	8/10-bit A/D converter data register upper	R/W	00000000 <sub>B</sub>
006F <sub>H</sub>	ADDL	8/10-bit A/D converter data register lower	R/W	00000000 <sub>B</sub>
0070 <sub>H</sub>	WCSR	Watch counter status register	R/W	00000000 <sub>B</sub>
0071 <sub>H</sub>	FSR2	Flash memory status register 2	R/W	00000000 <sub>B</sub>
0072 <sub>H</sub>	FSR	Flash memory status register	R/W	000X0000 <sub>B</sub>
0073 <sub>H</sub>	SWRE0	Flash memory sector write control register 0	R/W	00000000 <sub>B</sub>
0074 <sub>H</sub>	FSR3	Flash memory status register 3	R	00000000 <sub>B</sub>
0075 <sub>H</sub>	—	(Disabled)	—	—
0076 <sub>H</sub>	WREN	Wild register address compare enable register	R/W	00000000 <sub>B</sub>
0077 <sub>H</sub>	WROR	Wild register data test setting register	R/W	00000000 <sub>B</sub>
0078 <sub>H</sub>	—	Mirror of register bank pointer (RP) and direct bank pointer (DP)	—	—

(Continued)

# MB95310L/370L Series

Address	Register abbreviation	Register name	R/W	Initial value
0079 <sub>H</sub>	ILR0	Interrupt level setting register 0	R/W	11111111 <sub>B</sub>
007A <sub>H</sub>	ILR1	Interrupt level setting register 1	R/W	11111111 <sub>B</sub>
007B <sub>H</sub>	ILR2	Interrupt level setting register 2	R/W	11111111 <sub>B</sub>
007C <sub>H</sub>	ILR3	Interrupt level setting register 3	R/W	11111111 <sub>B</sub>
007D <sub>H</sub>	ILR4	Interrupt level setting register 4	R/W	11111111 <sub>B</sub>
007E <sub>H</sub>	ILR5	Interrupt level setting register 5	R/W	11111111 <sub>B</sub>
007F <sub>H</sub>	—	(Disabled)	—	—
0F80 <sub>H</sub>	WRARH0	Wild register address setting register (upper) ch. 0	R/W	00000000 <sub>B</sub>
0F81 <sub>H</sub>	WRARL0	Wild register address setting register (lower) ch. 0	R/W	00000000 <sub>B</sub>
0F82 <sub>H</sub>	WRDR0	Wild register data setting register ch. 0	R/W	00000000 <sub>B</sub>
0F83 <sub>H</sub>	WRARH1	Wild register address setting register (upper) ch. 1	R/W	00000000 <sub>B</sub>
0F84 <sub>H</sub>	WRARL1	Wild register address setting register (lower) ch. 1	R/W	00000000 <sub>B</sub>
0F85 <sub>H</sub>	WRDR1	Wild register data setting register ch. 1	R/W	00000000 <sub>B</sub>
0F86 <sub>H</sub>	WRARH2	Wild register address setting register (upper) ch. 2	R/W	00000000 <sub>B</sub>
0F87 <sub>H</sub>	WRARL2	Wild register address setting register (lower) ch. 2	R/W	00000000 <sub>B</sub>
0F88 <sub>H</sub>	WRDR2	Wild register data setting register ch. 2	R/W	00000000 <sub>B</sub>
0F89 <sub>H</sub> to 0F91 <sub>H</sub>	—	(Disabled)	—	—
0F92 <sub>H</sub>	T01CR0	8/16-bit composite timer 01 status control register 0 ch. 0	R/W	00000000 <sub>B</sub>
0F93 <sub>H</sub>	T00CR0	8/16-bit composite timer 00 status control register 0 ch. 0	R/W	00000000 <sub>B</sub>
0F94 <sub>H</sub>	T01DR	8/16-bit composite timer 01 data register ch. 0	R/W	00000000 <sub>B</sub>
0F95 <sub>H</sub>	T00DR	8/16-bit composite timer 00 data register ch. 0	R/W	00000000 <sub>B</sub>
0F96 <sub>H</sub>	TMCR0	8/16-bit composite timer 00/01 timer mode control register ch. 0	R/W	00000000 <sub>B</sub>
0F97 <sub>H</sub>	T11CR0	8/16-bit composite timer 11 status control register 0 ch. 1	R/W	00000000 <sub>B</sub>
0F98 <sub>H</sub>	T10CR0	8/16-bit composite timer 10 status control register 0 ch. 1	R/W	00000000 <sub>B</sub>
0F99 <sub>H</sub>	T11DR	8/16-bit composite timer 11 data register ch. 1	R/W	00000000 <sub>B</sub>
0F9A <sub>H</sub>	T10DR	8/16-bit composite timer 10 data register ch. 1	R/W	00000000 <sub>B</sub>
0F9B <sub>H</sub>	TMCR1	8/16-bit composite timer 10/11 timer mode control register ch. 1	R/W	00000000 <sub>B</sub>
0F9C <sub>H</sub>	PPS01	8/16-bit PPG01 cycle setting buffer register ch. 0	R/W	11111111 <sub>B</sub>
0F9D <sub>H</sub>	PPS00	8/16-bit PPG00 cycle setting buffer register ch. 0	R/W	11111111 <sub>B</sub>
0F9E <sub>H</sub>	PDS01	8/16-bit PPG01 duty setting buffer register ch. 0	R/W	11111111 <sub>B</sub>
0F9F <sub>H</sub>	PDS00	8/16-bit PPG00 duty setting buffer register ch. 0	R/W	11111111 <sub>B</sub>
0FA0 <sub>H</sub>	PPS11	8/16-bit PPG11 cycle setting buffer register ch. 1	R/W	11111111 <sub>B</sub>
0FA1 <sub>H</sub>	PPS10	8/16-bit PPG10 cycle setting buffer register ch. 1	R/W	11111111 <sub>B</sub>
0FA2 <sub>H</sub>	PDS11	8/16-bit PPG11 duty setting buffer register ch. 1	R/W	11111111 <sub>B</sub>
0FA3 <sub>H</sub>	PDS10	8/16-bit PPG10 duty setting buffer register ch. 1	R/W	11111111 <sub>B</sub>

(Continued)



# MB95310L/370L Series

Address	Register abbreviation	Register name	R/W	Initial value
0FA4 <sub>H</sub>	PPGS	8/16-bit PPG start register	R/W	00000000 <sub>B</sub>
0FA5 <sub>H</sub>	REVC	8/16-bit PPG output inversion register	R/W	00000000 <sub>B</sub>
0FA6 <sub>H</sub>	TMRH0	16-bit reload timer timer register upper	R/W	00000000 <sub>B</sub>
	TMRLRH0	16-bit reload timer reload register upper	R/W	00000000 <sub>B</sub>
0FA7 <sub>H</sub>	TMRL0	16-bit reload timer timer register lower	R/W	00000000 <sub>B</sub>
	TMRLRL0	16-bit reload timer reload register lower	R/W	00000000 <sub>B</sub>
0FA8 <sub>H</sub> to 0FBD <sub>H</sub>	—	(Disabled)	—	—
0FBE <sub>H</sub>	PSSR0	UART/SIO dedicated baud rate generator prescaler selecting register ch. 0	R/W	00000000 <sub>B</sub>
0FBF <sub>H</sub>	BRSR0	UART/SIO dedicated baud rate generator baud rate setting register ch. 0	R/W	00000000 <sub>B</sub>
0FC0 <sub>H</sub>	PSSR1	UART/SIO dedicated baud rate generator prescaler selecting register ch. 1	R/W	00000000 <sub>B</sub>
0FC1 <sub>H</sub>	BRSR1	UART/SIO dedicated baud rate generator baud rate setting register ch. 1	R/W	00000000 <sub>B</sub>
0FC2 <sub>H</sub>	—	(Disabled)	—	—
0FC3 <sub>H</sub>	AIDRL	A/D input disable register (lower)	R/W	00000000 <sub>B</sub>
0FC4 <sub>H</sub>	LCDC	LCDC control register	R/W	00010000 <sub>B</sub>
0FC5 <sub>H</sub>	LCDCE1	LCDC enable register 1	R/W	00110000 <sub>B</sub>
0FC6 <sub>H</sub>	LCDCE2	LCDC enable register 2	R/W	00000000 <sub>B</sub>
0FC7 <sub>H</sub>	LCDCE3	LCDC enable register 3	R/W	00000000 <sub>B</sub>
0FC8 <sub>H</sub>	LCDCE4	LCDC enable register 4	R/W	00000000 <sub>B</sub>
0FC9 <sub>H</sub>	LCDCE5	LCDC enable register 5	R/W	00000000 <sub>B</sub>
0FCA <sub>H</sub>	LCDCE6	LCDC enable register 6	R/W	00000000 <sub>B</sub>
0FCB <sub>H</sub>	LCDCB1	LCDC blinking setting register 1	R/W	00000000 <sub>B</sub>
0FCC <sub>H</sub>	LCDCB2	LCDC blinking setting register 2	R/W	00000000 <sub>B</sub>
0FCD <sub>H</sub> to 0FE0 <sub>H</sub>	LCDRAM	LCDC display RAM	R/W	00000000 <sub>B</sub>
0FE1 <sub>H</sub>	—	(Disabled)	—	—
0FE2 <sub>H</sub>	EVCR	Event counter control register	R/W	00000000 <sub>B</sub>
0FE3 <sub>H</sub>	WCDR	Watch counter data register	R/W	00111111 <sub>B</sub>
0FE4 <sub>H</sub>	CRTH	Main CR clock trimming register (upper)	R/W	0XXXXXXX <sub>B</sub>
0FE5 <sub>H</sub>	CRTL	Main CR clock trimming register (lower)	R/W	00XXXXXX <sub>B</sub>
0FE6 <sub>H</sub> to 0FE8 <sub>H</sub>	—	(Disabled)	—	—
0FE9 <sub>H</sub>	CMCR	Clock monitoring control register	R/W	XX000000 <sub>B</sub>
0FEA <sub>H</sub>	CMDR	Clock monitoring data register	R	00000000 <sub>B</sub>

(Continued)

# MB95310L/370L Series

(Continued)

Address	Register abbreviation	Register name	R/W	Initial value
0FEB <sub>H</sub>	WDTH	Watchdog timer selection ID register (upper)	R	XXXXXXXX <sub>B</sub>
0FEC <sub>H</sub>	WDTL	Watchdog timer selection ID register (lower)	R	XXXXXXXX <sub>B</sub>
0FED <sub>H</sub>	—	(Disabled)	—	—
0FEE <sub>H</sub>	ILSR	Input level select register	R/W	00000000 <sub>B</sub>
0FEF <sub>H</sub>	WICR	Interrupt pin control register	R/W	01000000 <sub>B</sub>
0FF0 <sub>H</sub> to 0FFF <sub>H</sub>	—	(Disabled)	—	—

- R/W access symbols

R/W : Readable / Writable

R : Read only

- Initial value symbols

0 : The initial value of this bit is “0”.

1 : The initial value of this bit is “1”.

X : The initial value of this bit is indeterminate.

Note: Do not write to an address that is “(Disabled)”. If a “(Disabled)” address is read, an indeterminate value is returned.

# MB95310L/370L Series

## ■ I/O MAP (MB95370L Series)

Address	Register abbreviation	Register name	R/W	Initial value
0000 <sub>H</sub>	PDR0	Port 0 data register	R/W	00000000 <sub>B</sub>
0001 <sub>H</sub>	DDR0	Port 0 direction register	R/W	00000000 <sub>B</sub>
0002 <sub>H</sub>	PDR1	Port 1 data register	R/W	00000000 <sub>B</sub>
0003 <sub>H</sub>	DDR1	Port 1 direction register	R/W	00000000 <sub>B</sub>
0004 <sub>H</sub>	—	(Disabled)	—	—
0005 <sub>H</sub>	WATR	Oscillation stabilization wait time setting register	R/W	11111111 <sub>B</sub>
0006 <sub>H</sub>	PLLC	PLL control register	R/W	00000000 <sub>B</sub>
0007 <sub>H</sub>	SYCC	System clock control register	R/W	XXXXXX11 <sub>B</sub>
0008 <sub>H</sub>	STBC	Standby control register	R/W	0000XXX <sub>B</sub>
0009 <sub>H</sub>	RSRR	Reset source register	R/W	000XXXX <sub>B</sub>
000A <sub>H</sub>	TBTC	Time-base timer control register	R/W	00000000 <sub>B</sub>
000B <sub>H</sub>	WPCR	Watch prescaler control register	R/W	00000000 <sub>B</sub>
000C <sub>H</sub>	WDTC	Watchdog timer control register	R/W	00000000 <sub>B</sub>
000D <sub>H</sub>	SYCC2	System clock control register 2	R/W	XX100011 <sub>B</sub>
000E <sub>H</sub>	PDR2	Port 2 data register	R/W	00000000 <sub>B</sub>
000F <sub>H</sub>	DDR2	Port 2 direction register	R/W	00000000 <sub>B</sub>
0010 <sub>H</sub> to 0015 <sub>H</sub>	—	(Disabled)	—	—
0016 <sub>H</sub>	PDR6	Port 6 data register	R/W	00000000 <sub>B</sub>
0017 <sub>H</sub>	DDR6	Port 6 direction register	R/W	00000000 <sub>B</sub>
0018 <sub>H</sub> to 001B <sub>H</sub>	—	(Disabled)	—	—
001C <sub>H</sub>	PDR9	Port 9 data register	R/W	00000000 <sub>B</sub>
001D <sub>H</sub>	DDR9	Port 9 direction register	R/W	00000000 <sub>B</sub>
001E <sub>H</sub>	PDRA	Port A data register	R/W	00000000 <sub>B</sub>
001F <sub>H</sub>	DDRA	Port A direction register	R/W	00000000 <sub>B</sub>
0020 <sub>H</sub>	PDRB	Port B data register	R/W	00000000 <sub>B</sub>
0021 <sub>H</sub>	DDRB	Port B direction register	R/W	00000000 <sub>B</sub>
0022 <sub>H</sub>	PDRC	Port C data register	R/W	00000000 <sub>B</sub>
0023 <sub>H</sub>	DDRC	Port C direction register	R/W	00000000 <sub>B</sub>
0024 <sub>H</sub> , 0025 <sub>H</sub>	—	(Disabled)	—	—
0026 <sub>H</sub>	PDRE	Port E data register	R/W	00000000 <sub>B</sub>
0027 <sub>H</sub>	DDRE	Port E direction register	R/W	00000000 <sub>B</sub>
0028 <sub>H</sub> to 002B <sub>H</sub>	—	(Disabled)	—	—
002C <sub>H</sub>	PUL0	Port 0 pull-up register	R/W	00000000 <sub>B</sub>
002D <sub>H</sub>	PUL1	Port 1 pull-up register	R/W	00000000 <sub>B</sub>
002E <sub>H</sub>	PUL2	Port 2 pull-up register	R/W	00000000 <sub>B</sub>

(Continued)

# MB95310L/370L Series

Address	Register abbreviation	Register name	R/W	Initial value
002F <sub>H</sub> to 0033 <sub>H</sub>	—	(Disabled)	—	—
0034 <sub>H</sub>	PUL9	Port 9 pull-up register	R/W	00000000 <sub>B</sub>
0035 <sub>H</sub>	—	(Disabled)	—	—
0036 <sub>H</sub>	T01CR1	8/16-bit composite timer 01 status control register 1 ch. 0	R/W	00000000 <sub>B</sub>
0037 <sub>H</sub>	T00CR1	8/16-bit composite timer 00 status control register 1 ch. 0	R/W	00000000 <sub>B</sub>
0038 <sub>H</sub>	T11CR1	8/16-bit composite timer 11 status control register 1 ch. 1	R/W	00000000 <sub>B</sub>
0039 <sub>H</sub>	T10CR1	8/16-bit composite timer 10 status control register 1 ch. 1	R/W	00000000 <sub>B</sub>
003A <sub>H</sub>	PC01	8/16-bit PPG01 control register ch. 0	R/W	00000000 <sub>B</sub>
003B <sub>H</sub>	PC00	8/16-bit PPG00 control register ch. 0	R/W	00000000 <sub>B</sub>
003C <sub>H</sub>	PC11	8/16-bit PPG11 control register ch. 1	R/W	00000000 <sub>B</sub>
003D <sub>H</sub>	PC10	8/16-bit PPG10 control register ch. 1	R/W	00000000 <sub>B</sub>
003E <sub>H</sub>	TMCSRH	16-bit reload timer control status register upper ch. 0	R/W	00000000 <sub>B</sub>
003F <sub>H</sub>	TMCSRL	16-bit reload timer control status register lower ch. 0	R/W	00000000 <sub>B</sub>
0040 <sub>H</sub> to 0047 <sub>H</sub>	—	(Disabled)	—	—
0048 <sub>H</sub>	EIC00	External interrupt circuit control register ch. 0/ch. 1	R/W	00000000 <sub>B</sub>
0049 <sub>H</sub>	EIC10	External interrupt circuit control register ch. 2/ch. 3	R/W	00000000 <sub>B</sub>
004A <sub>H</sub>	EIC20	External interrupt circuit control register ch. 4/ch. 5	R/W	00000000 <sub>B</sub>
004B <sub>H</sub>	EIC30	External interrupt circuit control register ch. 6/ch. 7	R/W	00000000 <sub>B</sub>
004C <sub>H</sub> , 004D <sub>H</sub>	—	(Disabled)	—	—
004E <sub>H</sub>	LVDR	LVD reset voltage selection ID register	R/W	00000000 <sub>B</sub>
004F <sub>H</sub>	LVDC	LVD control register	R/W	X000000X <sub>B</sub>
0050 <sub>H</sub> to 0055 <sub>H</sub>	—	(Disabled)	—	—
0056 <sub>H</sub>	SMC10	UART/SIO serial mode control register 1 ch. 0	R/W	00000000 <sub>B</sub>
0057 <sub>H</sub>	SMC20	UART/SIO serial mode control register 2 ch. 0	R/W	00100000 <sub>B</sub>
0058 <sub>H</sub>	SSR0	UART/SIO serial status register ch. 0	R/W	00000001 <sub>B</sub>
0059 <sub>H</sub>	TDR0	UART/SIO output data register ch. 0	R/W	00000000 <sub>B</sub>
005A <sub>H</sub>	RDR0	UART/SIO input data register ch. 0	R	00000000 <sub>B</sub>
005B <sub>H</sub>	SMC11	UART/SIO serial mode control register 1 ch. 1	R/W	00000000 <sub>B</sub>
005C <sub>H</sub>	SMC21	UART/SIO serial mode control register 2 ch. 1	R/W	00100000 <sub>B</sub>
005D <sub>H</sub>	SSR1	UART/SIO serial status register ch. 1	R/W	00000001 <sub>B</sub>
005E <sub>H</sub>	TDR1	UART/SIO output data register ch. 1	R/W	00000000 <sub>B</sub>
005F <sub>H</sub>	RDR1	UART/SIO input data register ch. 1	R	00000000 <sub>B</sub>

(Continued)

# MB95310L/370L Series

Address	Register abbreviation	Register name	R/W	Initial value
0060 <sub>H</sub>	IBCR00	I <sup>2</sup> C bus control register 0	R/W	00000001 <sub>B</sub>
0061 <sub>H</sub>	IBCR10	I <sup>2</sup> C bus control register 1	R/W	00000000 <sub>B</sub>
0062 <sub>H</sub>	IBCR0	I <sup>2</sup> C bus status register	R	00000000 <sub>B</sub>
0063 <sub>H</sub>	IDDR0	I <sup>2</sup> C data register	R/W	00000000 <sub>B</sub>
0064 <sub>H</sub>	IAAR0	I <sup>2</sup> C address register	R/W	00000000 <sub>B</sub>
0065 <sub>H</sub>	ICCR0	I <sup>2</sup> C clock control register	R/W	00000000 <sub>B</sub>
0066 <sub>H</sub> to 006B <sub>H</sub>	—	(Disabled)	—	—
006C <sub>H</sub>	ADC1	8/10-bit A/D converter control register 1	R/W	00000000 <sub>B</sub>
006D <sub>H</sub>	ADC2	8/10-bit A/D converter control register 2	R/W	00000000 <sub>B</sub>
006E <sub>H</sub>	ADDH	8/10-bit A/D converter data register upper	R/W	00000000 <sub>B</sub>
006F <sub>H</sub>	ADDL	8/10-bit A/D converter data register lower	R/W	00000000 <sub>B</sub>
0070 <sub>H</sub>	WCSR	Watch counter status register	R/W	00000000 <sub>B</sub>
0071 <sub>H</sub>	FSR2	Flash memory status register 2	R/W	00000000 <sub>B</sub>
0072 <sub>H</sub>	FSR	Flash memory status register	R/W	000X0000 <sub>B</sub>
0073 <sub>H</sub>	SWRE0	Flash memory sector write control register 0	R/W	00000000 <sub>B</sub>
0074 <sub>H</sub>	FSR3	Flash memory status register 3	R	00000000 <sub>B</sub>
0075 <sub>H</sub>	—	(Disabled)	—	—
0076 <sub>H</sub>	WREN	Wild register address compare enable register	R/W	00000000 <sub>B</sub>
0077 <sub>H</sub>	WROR	Wild register data test setting register	R/W	00000000 <sub>B</sub>
0078 <sub>H</sub>	—	Mirror of register bank pointer (RP) and direct bank pointer (DP)	—	—
0079 <sub>H</sub>	ILR0	Interrupt level setting register 0	R/W	11111111 <sub>B</sub>
007A <sub>H</sub>	ILR1	Interrupt level setting register 1	R/W	11111111 <sub>B</sub>
007B <sub>H</sub>	ILR2	Interrupt level setting register 2	R/W	11111111 <sub>B</sub>
007C <sub>H</sub>	ILR3	Interrupt level setting register 3	R/W	11111111 <sub>B</sub>
007D <sub>H</sub>	ILR4	Interrupt level setting register 4	R/W	11111111 <sub>B</sub>
007E <sub>H</sub>	ILR5	Interrupt level setting register 5	R/W	11111111 <sub>B</sub>
007F <sub>H</sub>	—	(Disabled)	—	—
0F80 <sub>H</sub>	WRARH0	Wild register address setting register (upper) ch. 0	R/W	00000000 <sub>B</sub>
0F81 <sub>H</sub>	WRARL0	Wild register address setting register (lower) ch. 0	R/W	00000000 <sub>B</sub>
0F82 <sub>H</sub>	WRDR0	Wild register data setting register ch. 0	R/W	00000000 <sub>B</sub>
0F83 <sub>H</sub>	WRARH1	Wild register address setting register (upper) ch. 1	R/W	00000000 <sub>B</sub>
0F84 <sub>H</sub>	WRARL1	Wild register address setting register (lower) ch. 1	R/W	00000000 <sub>B</sub>
0F85 <sub>H</sub>	WRDR1	Wild register data setting register ch. 1	R/W	00000000 <sub>B</sub>
0F86 <sub>H</sub>	WRARH2	Wild register address setting register (upper) ch. 2	R/W	00000000 <sub>B</sub>
0F87 <sub>H</sub>	WRARL2	Wild register address setting register (lower) ch. 2	R/W	00000000 <sub>B</sub>
0F88 <sub>H</sub>	WRDR2	Wild register data setting register ch. 2	R/W	00000000 <sub>B</sub>

(Continued)

# MB95310L/370L Series

Address	Register abbreviation	Register name	R/W	Initial value
0F89H to 0F91H	—	(Disabled)	—	—
0F92H	T01CR0	8/16-bit composite timer 01 status control register 0 ch. 0	R/W	00000000 <sub>B</sub>
0F93H	T00CR0	8/16-bit composite timer 00 status control register 0 ch. 0	R/W	00000000 <sub>B</sub>
0F94H	T01DR	8/16-bit composite timer 01 data register ch. 0	R/W	00000000 <sub>B</sub>
0F95H	T00DR	8/16-bit composite timer 00 data register ch. 0	R/W	00000000 <sub>B</sub>
0F96H	TMCR0	8/16-bit composite timer 00/01 timer mode control register ch. 0	R/W	00000000 <sub>B</sub>
0F97H	T11CR0	8/16-bit composite timer 11 status control register 0 ch. 1	R/W	00000000 <sub>B</sub>
0F98H	T10CR0	8/16-bit composite timer 10 status control register 0 ch. 1	R/W	00000000 <sub>B</sub>
0F99H	T11DR	8/16-bit composite timer 11 data register ch. 1	R/W	00000000 <sub>B</sub>
0F9AH	T10DR	8/16-bit composite timer 10 data register ch. 1	R/W	00000000 <sub>B</sub>
0F9BH	TMCR1	8/16-bit composite timer 10/11 timer mode control register ch. 1	R/W	00000000 <sub>B</sub>
0F9CH	PPS01	8/16-bit PPG01 cycle setting buffer register ch. 0	R/W	11111111 <sub>B</sub>
0F9DH	PPS00	8/16-bit PPG00 cycle setting buffer register ch. 0	R/W	11111111 <sub>B</sub>
0F9EH	PDS01	8/16-bit PPG01 duty setting buffer register ch. 0	R/W	11111111 <sub>B</sub>
0F9FH	PDS00	8/16-bit PPG00 duty setting buffer register ch. 0	R/W	11111111 <sub>B</sub>
0FA0H	PPS11	8/16-bit PPG11 cycle setting buffer register ch. 1	R/W	11111111 <sub>B</sub>
0FA1H	PPS10	8/16-bit PPG10 cycle setting buffer register ch. 1	R/W	11111111 <sub>B</sub>
0FA2H	PDS11	8/16-bit PPG11 duty setting buffer register ch. 1	R/W	11111111 <sub>B</sub>
0FA3H	PDS10	8/16-bit PPG10 duty setting buffer register ch. 1	R/W	11111111 <sub>B</sub>
0FA4H	PPGS	8/16-bit PPG start register	R/W	00000000 <sub>B</sub>
0FA5H	REVC	8/16-bit PPG output inversion register	R/W	00000000 <sub>B</sub>
0FA6H	TMRH0	16-bit reload timer timer register upper	R/W	00000000 <sub>B</sub>
	TMRLRH0	16-bit reload timer reload register upper	R/W	00000000 <sub>B</sub>
0FA7H	TMRL0	16-bit reload timer timer register lower	R/W	00000000 <sub>B</sub>
	TMRLRL0	16-bit reload timer reload register lower	R/W	00000000 <sub>B</sub>
0FA8H to 0FBDH	—	(Disabled)	—	—
0FBEH	PSSR0	UART/SIO dedicated baud rate generator prescaler selecting register ch. 0	R/W	00000000 <sub>B</sub>
0FBFH	BRSR0	UART/SIO dedicated baud rate generator baud rate setting register ch. 0	R/W	00000000 <sub>B</sub>
0FC0H	PSSR1	UART/SIO dedicated baud rate generator prescaler selecting register ch. 1	R/W	00000000 <sub>B</sub>
0FC1H	BRSR1	UART/SIO dedicated baud rate generator baud rate setting register ch. 1	R/W	00000000 <sub>B</sub>
0FC2H	—	(Disabled)	—	—
0FC3H	AIDRL	A/D input disable register (lower)	R/W	00000000 <sub>B</sub>
0FC4H	LCDC	LCDC control register	R/W	00010000 <sub>B</sub>

(Continued)

# MB95310L/370L Series

(Continued)

Address	Register abbreviation	Register name	R/W	Initial value
0FC5 <sub>H</sub>	LCDCE1	LCDC enable register 1	R/W	00110000 <sub>B</sub>
0FC6 <sub>H</sub>	LCDCE2	LCDC enable register 2	R/W	00000000 <sub>B</sub>
0FC7 <sub>H</sub>	LCDCE3	LCDC enable register 3	R/W	00000000 <sub>B</sub>
0FC8 <sub>H</sub>	LCDCE4	LCDC enable register 4	R/W	00000000 <sub>B</sub>
0FC9 <sub>H</sub>	LCDCE5	LCDC enable register 5	R/W	00000000 <sub>B</sub>
0FCA <sub>H</sub>	—	(Disabled)	—	—
0FCB <sub>H</sub>	LCDCB1	LCDC blinking setting register 1	R/W	00000000 <sub>B</sub>
0FCC <sub>H</sub>	LCDCB2	LCDC blinking setting register 2	R/W	00000000 <sub>B</sub>
0FCD <sub>H</sub> to 0FDC <sub>H</sub>	LCDRAM	LCDC display RAM	R/W	00000000 <sub>B</sub>
0FDD <sub>H</sub> to 0FE1 <sub>H</sub>	—	(Disabled)	—	—
0FE2 <sub>H</sub>	EVCR	Event counter control register	R/W	00000000 <sub>B</sub>
0FE3 <sub>H</sub>	WCDR	Watch counter data register	R/W	00111111 <sub>B</sub>
0FE4 <sub>H</sub>	CRTH	Main CR clock trimming register (upper)	R/W	0XXXXXXXX <sub>B</sub>
0FE5 <sub>H</sub>	CRTL	Main CR clock trimming register (lower)	R/W	00XXXXXXXX <sub>B</sub>
0FE6 <sub>H</sub> to 0FE8 <sub>H</sub>	—	(Disabled)	—	—
0FE9 <sub>H</sub>	CMCR	Clock monitoring control register	R/W	XX000000 <sub>B</sub>
0FEA <sub>H</sub>	CMDR	Clock monitoring data register	R	00000000 <sub>B</sub>
0FEB <sub>H</sub>	WDTH	Watchdog timer selection ID register (upper)	R	XXXXXXXX <sub>B</sub>
0FEC <sub>H</sub>	WDTL	Watchdog timer selection ID register (lower)	R	XXXXXXXX <sub>B</sub>
0FED <sub>H</sub>	—	(Disabled)	—	—
0FEE <sub>H</sub>	ILSR	Input level select register	R/W	00000000 <sub>B</sub>
0FEF <sub>H</sub>	WICR	Interrupt pin control register	R/W	01000000 <sub>B</sub>
0FF0 <sub>H</sub> to 0FFF <sub>H</sub>	—	(Disabled)	—	—

• R/W access symbols

R/W : Readable / Writable

R : Read only

• Initial value symbols

0 : The initial value of this bit is "0".



1 : The initial value of this bit is "1".

X : The initial value of this bit is indeterminate.

Note: Do not write to an address that is "(Disabled)". If a "(Disabled)" address is read, an indeterminate value is returned.

# MB95310L/370L Series

## ■ INTERRUPT SOURCE TABLE

Interrupt source	Interrupt request number	Vector table address		Bit name of interrupt level setting register	Priority order of interrupt sources of the same level (occurring simultaneously)
		Upper	Lower		
External interrupt ch. 0	IRQ00	FFFA <sub>H</sub>	FFFB <sub>H</sub>	L00 [1:0]	High   Low
External interrupt ch. 4					
External interrupt ch. 1	IRQ01	FFF8 <sub>H</sub>	FFF9 <sub>H</sub>	L01 [1:0]	
External interrupt ch. 5					
External interrupt ch. 2	IRQ02	FFF6 <sub>H</sub>	FFF7 <sub>H</sub>	L02 [1:0]	
External interrupt ch. 6					
External interrupt ch. 3	IRQ03	FFF4 <sub>H</sub>	FFF5 <sub>H</sub>	L03 [1:0]	
External interrupt ch. 7					
UART/SIO ch. 0	IRQ04	FFF2 <sub>H</sub>	FFF3 <sub>H</sub>	L04 [1:0]	
Low-voltage detection reset circuit					
8/16-bit composite timer ch. 0 (lower)	IRQ05	FFF0 <sub>H</sub>	FFF1 <sub>H</sub>	L05 [1:0]	
8/16-bit composite timer ch. 0 (upper)	IRQ06	FFEE <sub>H</sub>	FFEF <sub>H</sub>	L06 [1:0]	
—	IRQ07	FFEC <sub>H</sub>	FFED <sub>H</sub>	L07 [1:0]	
—	IRQ08	FFEA <sub>H</sub>	FFEB <sub>H</sub>	L08 [1:0]	
8/16-bit PPG ch. 1 (lower)	IRQ09	FFE8 <sub>H</sub>	FFE9 <sub>H</sub>	L09 [1:0]	
UART/SIO ch. 1					
8/16-bit PPG ch. 1 (upper)	IRQ10	FFE6 <sub>H</sub>	FFE7 <sub>H</sub>	L10 [1:0]	
16-bit reload timer ch. 0	IRQ11	FFE4 <sub>H</sub>	FFE5 <sub>H</sub>	L11 [1:0]	
8/16-bit PPG ch. 0 (upper)	IRQ12	FFE2 <sub>H</sub>	FFE3 <sub>H</sub>	L12 [1:0]	
8/16-bit PPG ch. 0 (lower)	IRQ13	FFE0 <sub>H</sub>	FFE1 <sub>H</sub>	L13 [1:0]	
8/16-bit composite timer ch. 1 (upper)	IRQ14	FFDE <sub>H</sub>	FFDF <sub>H</sub>	L14 [1:0]	
—	IRQ15	FFDC <sub>H</sub>	FFDD <sub>H</sub>	L15 [1:0]	
I <sup>2</sup> C	IRQ16	FFDA <sub>H</sub>	FFDB <sub>H</sub>	L16 [1:0]	
—	IRQ17	FFD8 <sub>H</sub>	FFD9 <sub>H</sub>	L17 [1:0]	
8/10-bit A/D converter	IRQ18	FFD6 <sub>H</sub>	FFD7 <sub>H</sub>	L18 [1:0]	
Time-base timer	IRQ19	FFD4 <sub>H</sub>	FFD5 <sub>H</sub>	L19 [1:0]	
Watch prescaler	IRQ20	FFD2 <sub>H</sub>	FFD3 <sub>H</sub>	L20 [1:0]	
Watch counter					
—	IRQ21	FFD0 <sub>H</sub>	FFD1 <sub>H</sub>	L21 [1:0]	
8/16-bit composite timer ch. 1 (lower)	IRQ22	FFCE <sub>H</sub>	FFCF <sub>H</sub>	L22 [1:0]	
Flash memory	IRQ23	FFCC <sub>H</sub>	FFCD <sub>H</sub>	L23 [1:0]	



## ■ ELECTRICAL CHARACTERISTICS

### 1. Absolute Maximum Ratings

Parameter	Symbol	Rating		Unit	Remarks
		Min	Max		
Power supply voltage*1	$V_{CC}, AV_{CC}$	$V_{SS} - 0.3$	$V_{SS} + 4.0$	V	*2
Power supply voltage for LCD	$V_0$ to $V_3$	$V_{SS} - 0.3$	$V_{SS} + 4.0$	V	Products with LCD internal division resistance*3
Input voltage*1	$V_i$	$V_{SS} - 0.3$	$V_{SS} + 6.0$	V	P23,P24*4
		$V_{SS} - 0.3$	$V_{SS} + 4.0$	V	Other than P23,P24*4
Output voltage*1	$V_o$	$V_{SS} - 0.3$	$V_{SS} + 4.0$	V	*4
Maximum clamp current	$I_{CLAMP}$	-2.0	+2.0	mA	Applicable to specific pins <sup>5</sup>
Total maximum clamp current	$\Sigma I_{CLAMP} $	—	20	mA	Applicable to specific pins <sup>5</sup>
“L” level maximum output current	$I_{OL}$	—	15	mA	Applicable to specific pins <sup>5</sup>
“L” level average current	$I_{OLAV}$	—	4	mA	Applicable to specific pins <sup>5</sup> Average output current = operating current × operating ratio (1 pin)
“L” level total maximum output current	$\Sigma I_{OL}$	—	100	mA	
“L” level total average output current	$\Sigma I_{OLAV}$	—	50	mA	Total average output current = operating current × operating ratio (Total number of pins)
“H” level maximum output current	$I_{OH}$	—	-15	mA	Applicable to specific pins <sup>5</sup>
“H” level average current	$I_{OHAV}$	—	-4	mA	Applicable to specific pins <sup>5</sup> Average output current = operating current × operating ratio (1 pin)
“H” level total maximum output current	$\Sigma I_{OH}$	—	-100	mA	
“H” level total average output current	$\Sigma I_{OHAV}$	—	-50	mA	Total average output current = operating current × operating ratio (Total number of pins)
Power consumption	$P_d$	—	320	mW	
Operating temperature	$T_A$	-40	+85	°C	
Storage temperature	$T_{stg}$	-55	+150	°C	

\*1: These parameters are based on the condition that  $V_{SS}$  is 0.0 V.

\*2: Apply equal potential to  $V_{CC}$  and  $AV_{CC}$ .

\*3:  $V_0$  to  $V_3$  should not exceed  $V_{CC} + 0.3$  V.

\*4:  $V_i$  and  $V_o$  must not exceed  $V_{CC} + 0.3$  V.  $V_i$  must not exceed the rated voltage. However, if the maximum current to/from an input is limited by means of an external component, the  $I_{CLAMP}$  rating is used instead of the  $V_i$  rating.

(Continued)

# MB95310L/370L Series

(Continued)

\*5: Applicable to the following pins: P00 to P07, P10, P11, P13 to P16, P20 to P22, P40 to P43, P50 to P53, P60 to P67, P90 to P95, PA0 to PA3, PB0 to PB7, PC0 to PC7, PE0 to PE7, PG0

- Use under recommended operating conditions.
- Use with DC voltage (current).
- The HV (High Voltage) signal is an input signal exceeding the  $V_{CC}$  voltage. Always connect a limiting resistor between the HV (High Voltage) signal and the microcontroller before applying the HV (High Voltage) signal.
- The value of the limiting resistance should be set so that when the HV (High Voltage) signal is applied the input current to the microcontroller pin does not exceed rated values, either instantaneously or for prolonged periods.
- When the microcontroller drive current is low, such as in low power consumption modes, the HV (High Voltage) input potential may pass through the protective diode to increase the potential of the  $V_{CC}$  pin, and thus affects other devices.
- If the HV (High Voltage) signal is input when the microcontroller power supply is off (not fixed at 0 V), since power is supplied from the pins, incomplete operations may be executed.
- If the HV (High Voltage) input is input after power-on, since power is supplied from the pins, the voltage of power supply may not be sufficient to enable a power-on reset.
- Do not leave the HV (High Voltage) input pin unconnected.
- Example of a recommended circuit

- Input/Output equivalent circuit

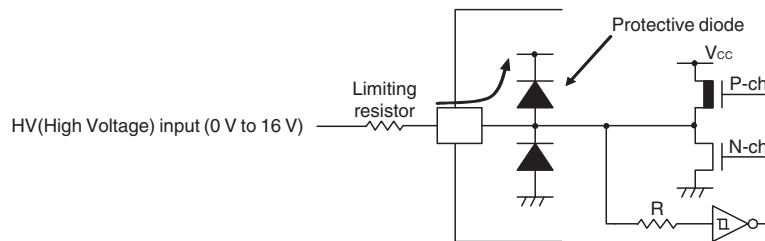

**WARNING:** Semiconductor devices can be permanently damaged by application of stress (voltage, current, temperature, etc.) in excess of absolute maximum ratings. Do not exceed these ratings.

## 2. Recommended Operating Conditions

(V<sub>SS</sub> = 0.0 V)

Parameter	Symbol	Value		Unit	Remarks	
		Min	Max			
Power supply voltage	V <sub>CC</sub> , AV <sub>CC</sub>	1.8*1*2*3	3.6	V	In normal operation, T <sub>A</sub> = -10°C to +85°C	Other than on-chip debug mode
		2.0	3.6		In normal operation, T <sub>A</sub> = -40°C to +85°C	
		1.5	3.6		Hold condition in stop mode	
		3.10*3	3.6		T <sub>A</sub> = +5°C to +35°C	On-chip debug mode
		1.5	3.6		Hold condition in stop mode	
Operating temperature	T <sub>A</sub>	-40	+85	°C	Other than on-chip debug mode	
		+5	+35		On-chip debug mode	

\*1: The value varies depending on the operating frequency, the machine clock and the analog guaranteed range.

\*2: The value is initially 2.03 V when the low-voltage detection reset is used.

\*3: The threshold voltage can be set to be 2.03 V, 2.55 V, 3.10 V by software.

**WARNING:** The recommended operating conditions are required in order to ensure the normal operation of the semiconductor device. All of the device's electrical characteristics are warranted when the device is operated within these ranges.

Always use semiconductor devices within their recommended operating condition ranges.

Operation outside these ranges may adversely affect reliability and could result in device failure.

No warranty is made with respect to uses, operating conditions, or combinations not represented on the data sheet. Users considering application outside the listed conditions are advised to contact their representatives beforehand.

# MB95310L/370L Series

## 3. DC Characteristics

( $V_{CC} = 3.0 V \pm 10\%$ ,  $V_{SS} = 0.0 V$ ,  $T_A = -40^\circ C$  to  $+85^\circ C$ )

Parameter	Symbol	Pin name	Condition	Value			Unit	Remarks
				Min	Typ <sup>5</sup>	Max		
"H" level input voltage	$V_{IH1}$	P10, P95 <sup>1</sup> , PE6 <sup>2</sup>	*3	$0.7 V_{CC}$	—	$V_{CC} + 0.3$	V	When selecting CMOS input level
	$V_{IH2}$	P23, P24	*3	$0.7 V_{CC}$	—	$V_{SS} + 5.5$	V	
	$V_{IHS1}$	P00 to P07, P10 to P16, P20 to P22, P40 to P43 <sup>1</sup> , P50 to P53 <sup>1</sup> , P60 to P67, P90 to P92, P93 to P95 <sup>1</sup> , PA0 to PA3, PB0 to PB7, PC0 to PC3, PC4 to PC7 <sup>1</sup> , PE0 to PE7, PG0 <sup>1</sup>	*3	$0.8 V_{CC}$	—	$V_{CC} + 0.3$	V	Hysteresis input
	$V_{IHS2}$	P23, P24	*3	$0.8 V_{CC}$	—	$V_{SS} + 5.5$	V	
	$V_{IHM}$	$\overline{RST}$	—	$0.8 V_{CC}$	—	$V_{CC} + 0.3$	V	
"L" level input voltage	$V_{IL}$	P10, P23, P24, P95 <sup>1</sup> , PE6 <sup>2</sup>	*3	$V_{SS} - 0.3$	—	$0.3 V_{CC}$	V	When selecting CMOS input level
	$V_{ILS}$	P00 to P07, P10 to P16, P20 to P24, P40 to P43 <sup>1</sup> , P50 to P53 <sup>1</sup> , P60 to P67, P90 to P92, P93 to P95 <sup>1</sup> , PA0 to PA3, PB0 to PB7, PC0 to PC3, PC4 to PC7 <sup>1</sup> , PE0 to PE7, PG0 <sup>1</sup>	*3	$V_{SS} - 0.3$	—	$0.2 V_{CC}$	V	Hysteresis input
	$V_{ILM}$	$\overline{RST}$	—	$V_{SS} - 0.3$	—	$0.2 V_{CC}$	V	
"H" level output voltage	$V_{OH}$	Output pin other than P12, P23, P24	$I_{OH} = 4.0 \text{ mA}$	$V_{CC} - 0.5$	—	—	V	
"L" level output voltage	$V_{OL}$	Output pin other than $\overline{RST}$	$I_{OL} = 4.0 \text{ mA}$	—	—	0.4	V	

(Continued)

# MB95310L/370L Series

( $V_{CC} = 3.0 V \pm 10\%$ ,  $V_{SS} = 0.0 V$ ,  $T_A = -40^\circ C$  to  $+85^\circ C$ )

Parameter	Symbol	Pin name	Condition	Value			Unit	Remarks
				Min	Typ*5	Max		
Input leakage current (Hi-Z output leakage current)	$I_{LI}$	Ports other than P12, P23, P24	$0.0 V < V_I < V_{CC}$	-5	—	+5	$\mu A$	When pull-up resistance is disabled
Open-drain output leakage voltage	$I_{LIOD}$	P12, P23, P24	$0.0 V < V_I < V_{SS} + 5.5 V$	—	—	5	$\mu A$	
Pull-up resistance	$R_{PULL}$	P00 to P03, P10, P11, P13 to P16, P20 to P22, P50 to P53*1, P94, P95*1, PG0*1	$V_I = 0.0 V$	25	50	100	$k\Omega$	When pull-up resistance is enabled
Input capacitance	$C_{IN}$	Other than $V_{CC}$ and $V_{SS}$	$f = 1 MHz$	—	5	15	$pF$	
Power supply current*4	$I_{CC}$	$V_{CC}$ (External clock operation)	$F_{CH} = 32 MHz$ $F_{MP} = 16 MHz$ Main clock mode (divided by 2)	—	16.5	27.7	$mA$	Except during Flash memory programming and erasing
				—	38.1	44.9	$mA$	During Flash memory programming and erasing
	$I_{CCS}$		$F_{CH} = 32 MHz$ $F_{MP} = 16 MHz$ Main sleep mode (divided by 2)	—	9	15.9	$mA$	
	$I_{CCL}$		$F_{CL} = 32 kHz$ $F_{MPL} = 16 kHz$ Subclock mode (divided by 2) $T_A = +25^\circ C$	—	22.6	37.9	$\mu A$	

(Continued)

# MB95310L/370L Series

( $V_{CC} = 3.0\text{ V} \pm 10\%$ ,  $V_{SS} = 0.0\text{ V}$ ,  $T_A = -40^\circ\text{C}$  to  $+85^\circ\text{C}$ )

Parameter	Symbol	Pin name	Condition	Value			Unit	Remarks
				Min	Typ <sup>5</sup>	Max		
Power supply current*4	I <sub>CCLS</sub>	V <sub>CC</sub> (External clock operation)	F <sub>CL</sub> = 32 kHz F <sub>MPL</sub> = 16 kHz Subsleep mode (divided by 2) T <sub>A</sub> = +25°C	—	11.2	16.5	μA	
	I <sub>CCCT</sub>		F <sub>CL</sub> = 32 kHz Watch mode Main stop mode T <sub>A</sub> = +25°C	—	6.7	9	μA	
	I <sub>CCMPLL</sub>		F <sub>CH</sub> = 4 MHz F <sub>MP</sub> = 10 MHz Main PLL mode (multiplied by 2.5)	—	10.1	19.2	mA	
			F <sub>CH</sub> = 6.4 MHz F <sub>MP</sub> = 16 MHz Main PLL mode (multiplied by 2.5)	—	16.2	30.7	mA	
	I <sub>CCMCR</sub>		F <sub>CRH</sub> = 12.5 MHz F <sub>MP</sub> = 12.5 MHz Main CR clock mode	—	7.9	13.2	mA	
	I <sub>CCSCR</sub>		Sub-CR clock mode (divided by 2) T <sub>A</sub> = +25°C	—	77.8	138.5	μA	
	I <sub>CTS</sub>		F <sub>CH</sub> = 32 MHz Time-base timer mode T <sub>A</sub> = +25°C	—	4.3	7.4	mA	
	I <sub>CCH</sub>		Substop mode T <sub>A</sub> = +25°C	—	1	5	μA	
	I <sub>A</sub>	AV <sub>CC</sub>	Current consumption for A/D conversion at 16 MHz	—	0.8	1.9	mA	
	I <sub>AH</sub>		Current consumption for stopping A/D conversion at 16 MHz	—	1	5	μA	

(Continued)

# MB95310L/370L Series

(Continued)

( $V_{CC} = 3.0 \text{ V} \pm 10\%$ ,  $V_{SS} = 0.0 \text{ V}$ ,  $T_A = -40^\circ\text{C}$  to  $+85^\circ\text{C}$ )

Parameter	Symbol	Pin name	Condition	Value			Unit	Remarks
				Min	Typ <sup>*5</sup>	Max		
Power supply current <sup>*4</sup>	$I_{LVD}$	$V_{CC}$	Current consumption for the low-voltage detection reset circuit	—	6	9.8	$\mu\text{A}$	
	$I_{CRH}$		Current consumption for the main CR oscillator	—	0.5	0.6	$\text{mA}$	
	$I_{CRL}$		Current consumption for the sub-CR oscillator oscillating at 100 kHz	—	20	72	$\mu\text{A}$	
LCD internal division resistance	$R_{LCD}$	—	Between $V_3$ and $V_{SS}$	—	300	—	$\text{k}\Omega$	
COM0 to COM3 output impedance	$R_{VCOM}$	COM0 to COM3	$V_1$ to $V_3 = 3.6 \text{ V}$	—	—	5	$\text{k}\Omega$	
SEG00 to SEG39 output impedance	$R_{VSEG}$	SEG00 to SEG39		—	—	7	$\text{k}\Omega$	
LCD leakage current	$I_{LCDL}$	$V_0$ to $V_3$ , COM0 to COM3, SEG00 to SEG39	—	-1	—	+1	$\mu\text{A}$	

\*1: It is for MB95310L Series.

\*2: It is for MB95370L Series.

\*3: The input level can be switched between “CMOS input level” and “hysteresis input level”. The input level selection register (ILSR) is used to switch between the two input levels.

\*4: • The power supply current is determined by the external clock. When the low-voltage detection option is selected, the power-supply current will be the sum of adding the current consumption of the low-voltage detection circuit ( $I_{LVD}$ ) to one of the value from  $I_{CC}$  to  $I_{CCH}$ . In addition, when both the low-voltage detection option and the CR oscillator are selected, the power supply current will be the sum of adding up the current consumption of the low-voltage detection circuit, the current consumption of the CR oscillators ( $I_{CRH}$ ,  $I_{CRL}$ ) and a specified value. In on-chip debug mode, the CR oscillator ( $I_{CRH}$ ) and the low-voltage detection circuit are always enabled, and current consumption therefore increases accordingly.

• See “4. AC Characteristics: (1) Clock Timing” for  $F_{CH}$  and  $F_{CL}$ .

• See “4. AC Characteristics: (2) Source Clock/Machine Clock” for  $F_{MP}$  and  $F_{MPL}$ .

\*5:  $V_{CC} = 3.0 \text{ V}$ ,  $T_A = +25^\circ\text{C}$

# MB95310L/370L Series

## 4. AC Characteristics

### (1) Clock Timing

( $V_{CC} = 3.0\text{ V} \pm 10\%$ ,  $V_{SS} = 0.0\text{ V}$ ,  $T_A = -40^\circ\text{C}$  to  $+85^\circ\text{C}$ )

Parameter	Symbol	Pin name	Condition	Value			Unit	Remarks		
				Min	Typ	Max				
Clock frequency	F <sub>CH</sub>	X0, X1	—	1.00	—	16.25	MHz	When the main oscillation circuit is used		
				1.00	—	32.50	MHz	When the main external clock is used		
				3.00	—	8.13	MHz	Main PLL multiplied by 2		
				3.00	—	6.5	MHz	Main PLL multiplied by 2.5		
				3.00	—	4.06	MHz	Main PLL multiplied by 4		
	F <sub>CRH</sub>	—	—	—	12.25	12.5	12.75	MHz	Operating conditions: • The main CR clock is used. • $T_A = -10^\circ\text{C}$ to $+85^\circ\text{C}$	
					9.8	10	10.2	MHz		
					7.84	8	8.16	MHz		
					0.98	1	1.02	MHz		
		—	—	—	—	12.1875	12.5	12.8125		MHz
						9.75	10	10.25		MHz
						7.8	8	8.2		MHz
						0.975	1	1.025		MHz
	F <sub>CL</sub>	X0A, X1A	—	—	—	32.768	—	kHz	When the sub-oscillation circuit is used	
—					32.768	—	kHz	When the sub-external clock is used		
50					100	200	kHz	When the sub-CR clock is used		
F <sub>CRL</sub>	—	—	—	50	100	200	kHz	When the sub-CR clock is used		
				50	100	200	kHz	When the sub-CR clock is used		
Clock cycle time	t <sub>H CYL</sub>	X0, X1	—	61.5	—	1000	ns	When the main oscillation circuit is used		
				30.8	—	1000	ns	When the external clock is used		
	t <sub>L CYL</sub>	X0A, X1A	—	—	30.5	—	μs	When the subclock is used		
Input clock pulse width	t <sub>WH1</sub> t <sub>WL1</sub>	X0	—	61.5	—	—	ns	When using external clock and the duty ratio is about 30% to 70%		
	t <sub>WH2</sub> t <sub>WL2</sub>	X0A		—	15.2	—	μs			
Input clock rise time and fall time	t <sub>CR</sub> t <sub>CF</sub>	X0, X0A	X1: open	—	—	5	ns	When the external clock is used		
CR oscillation start time	t <sub>CRHWK</sub>	—	—	—	—	150	μs	When the main CR clock is used		
	t <sub>CRLWK</sub>	—	—	—	—	10	μs	When the sub-CR clock is used		



- Input waveform generated when an external clock (main clock) is used

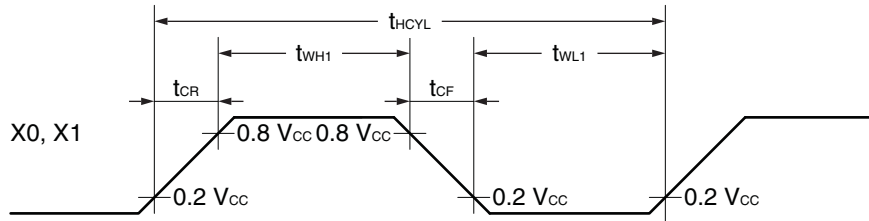

- Figure of main clock input port external connection

When a crystal oscillator or a ceramic oscillator is used

When the external clock is used (X1 is open)

When the external clock is used

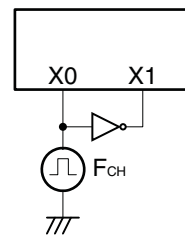
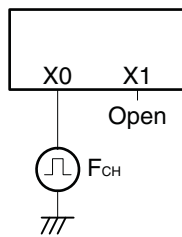
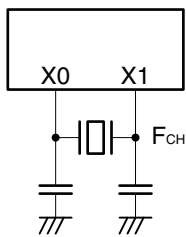

- Input waveform generated when an external clock (subclock) is used

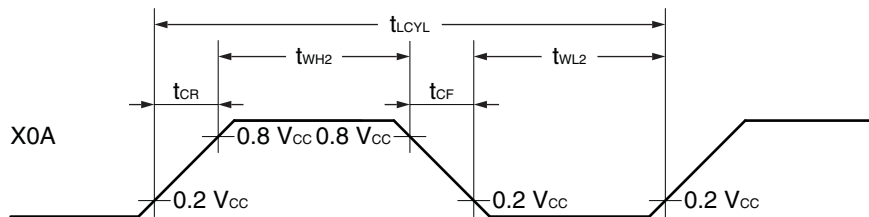

- Figure of subclock input port external connection

When a crystal oscillator or a ceramic oscillator is used

When the external clock is used

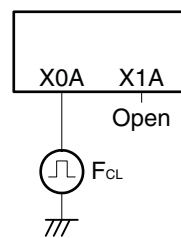
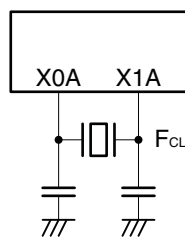

# MB95310L/370L Series

## (2) Source Clock/Machine Clock

( $V_{CC} = 3.0 V \pm 10\%$ ,  $V_{SS} = 0.0 V$ ,  $T_A = -40^\circ C$  to  $+85^\circ C$ )

Parameter	Symbol	Pin name	Value			Unit	Remarks
			Min	Typ	Max		
Source clock cycle time*1	$t_{SCLK}$	—	61.5	—	2000	ns	When the main oscillation clock is used Min: $F_{CH} = 8.125$ MHz, multiplied by the PLL multiplier of 2 Max: $F_{CH} = 1$ MHz, divided by 2
			80	—	1000	ns	When the main CR clock is used Min: $F_{CRH} = 12.5$ MHz Max: $F_{CRH} = 1$ MHz
			—	61	—	$\mu s$	When the sub-oscillation clock is used $F_{CL} = 32.768$ kHz, divided by 2
			—	20	—	$\mu s$	When the sub-CR clock is used $F_{CRL} = 100$ kHz, divided by 2
Source clock frequency	$F_{SP}$	—	0.50	—	16.25	MHz	When the main oscillation clock is used
			1	—	12.5	MHz	When the main CR clock is used
	—		16.384	—	kHz	When the sub-oscillation clock is used	
	$F_{SPL}$		—	50	—	kHz	When the sub-CR clock is used $F_{CRL} = 100$ kHz, divided by 2
Machine clock cycle time*2 (minimum instruction execution time)	$t_{MCLK}$	—	61.5	—	32000	ns	When the main oscillation clock is used Min: $F_{SP} = 16.25$ MHz, no division Max: $F_{SP} = 0.5$ MHz, divided by 16
			80	—	16000	ns	When the main CR clock is used Min: $F_{SP} = 12.5$ MHz Max: $F_{SP} = 1$ MHz, divided by 16
			61	—	976.5	$\mu s$	When the sub-oscillation clock is used Min: $F_{SPL} = 16.393$ kHz, no division Max: $F_{SPL} = 16.393$ kHz, divided by 16
			20	—	320	$\mu s$	When the sub-CR clock is used Min: $F_{SPL} = 50$ kHz, no division Max: $F_{SPL} = 50$ kHz, divided by 16
Machine clock frequency	$F_{MP}$	—	0.031	—	16.25	MHz	When the main oscillation clock is used
			0.0625	—	12.5	MHz	When the main CR clock is used
	$F_{MPL}$		1.024	—	16.384	kHz	When the sub-oscillation clock is used
			3.125	—	50	kHz	When the sub-CR clock is used $F_{CRL} = 100$ kHz

\*1: This is the clock before it is divided according to the division ratio set by the machine clock divide ratio select bits (SYCC:DIV1 and DIV0). This source clock is divided to become a machine clock according to the division ratio set by the machine clock divide ratio select bits (SYCC:DIV1 and DIV0). In addition, a source clock can be selected from the following.

- Main clock divided by 2
- PLL multiplication of main clock (select from 2, 2.5, 4 multiplication)
- Main CR clock divided by 2
- Subclock divided by 2
- Sub-CR clock divided by 2

(Continued)

(Continued)

\*2: This is the operating clock of the microcontroller. A machine clock can be selected from the following.

- Source clock (no division)
- Source clock divided by 4
- Source clock divided by 8
- Source clock divided by 16

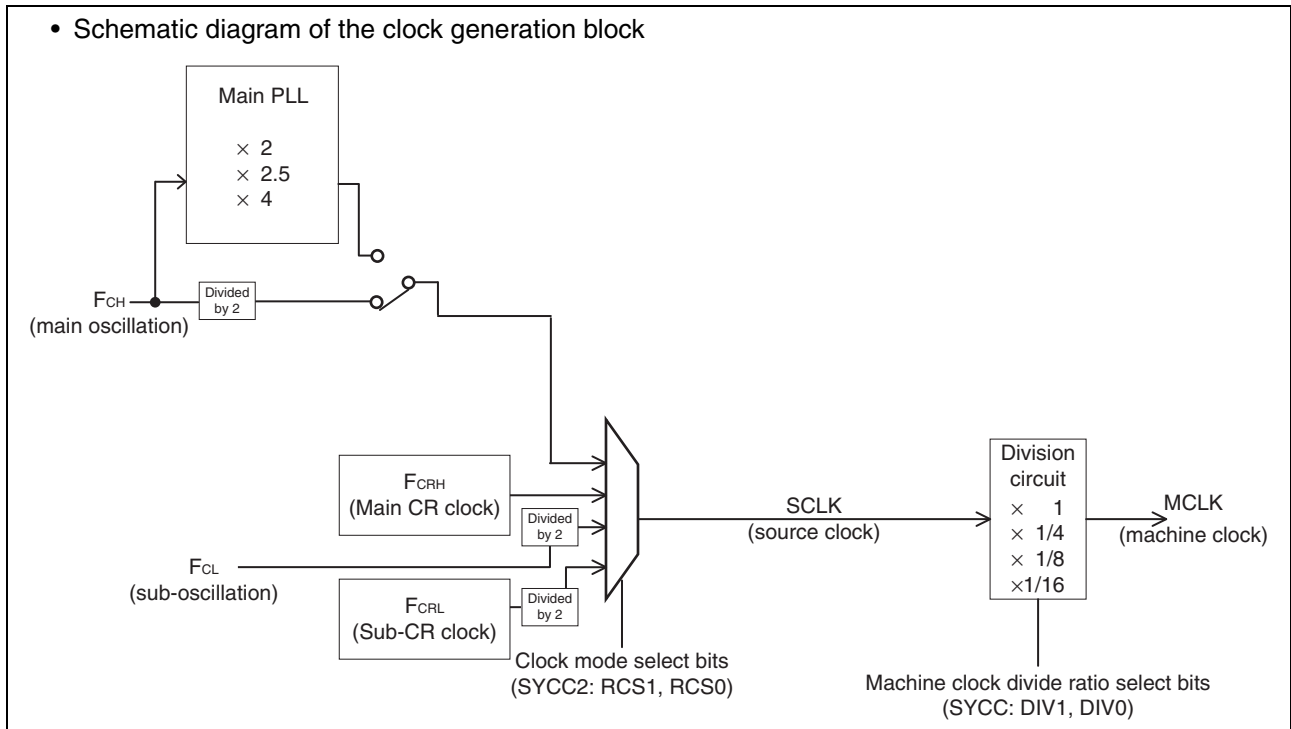

# MB95310L/370L Series

- Operating voltage - Operating frequency (When  $T_A = -10^\circ\text{C}$  to  $+85^\circ\text{C}$ )  
Without the on-chip debug function

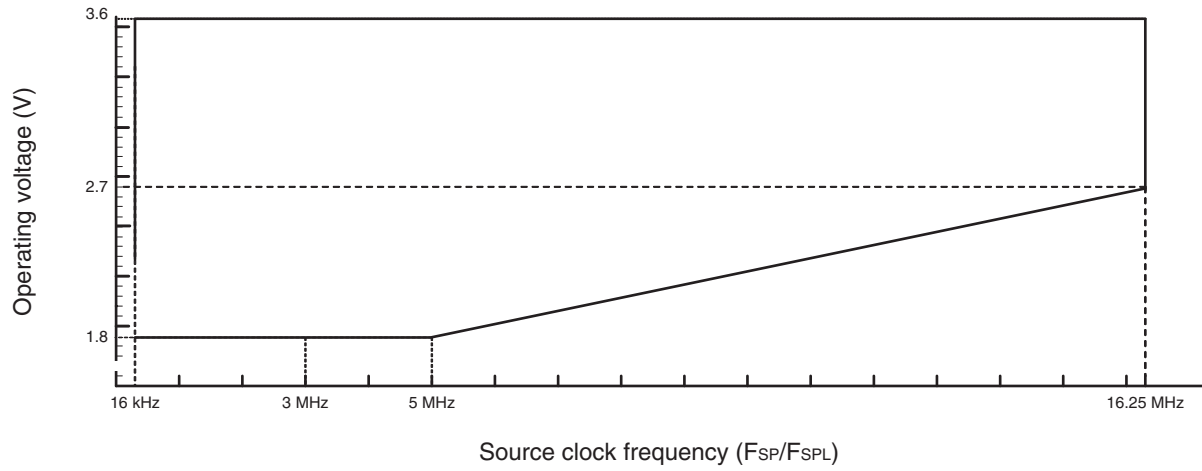

- Operating voltage - Operating frequency (When  $T_A = -40^\circ\text{C}$  to  $+85^\circ\text{C}$ )  
Without the on-chip debug function

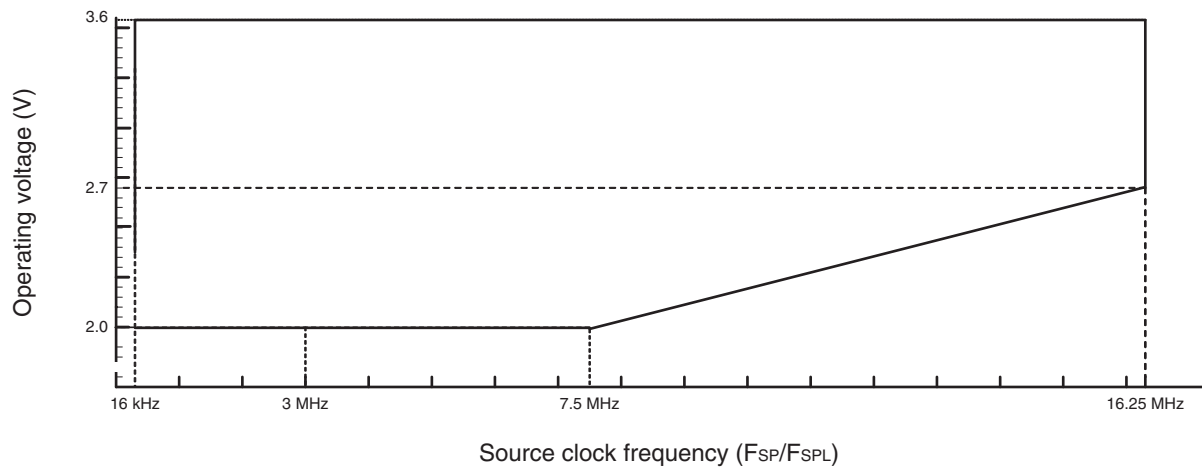

- Operating voltage - Operating frequency (When  $T_A = +5^\circ\text{C}$  to  $+35^\circ\text{C}$ )  
With the on-chip debug function

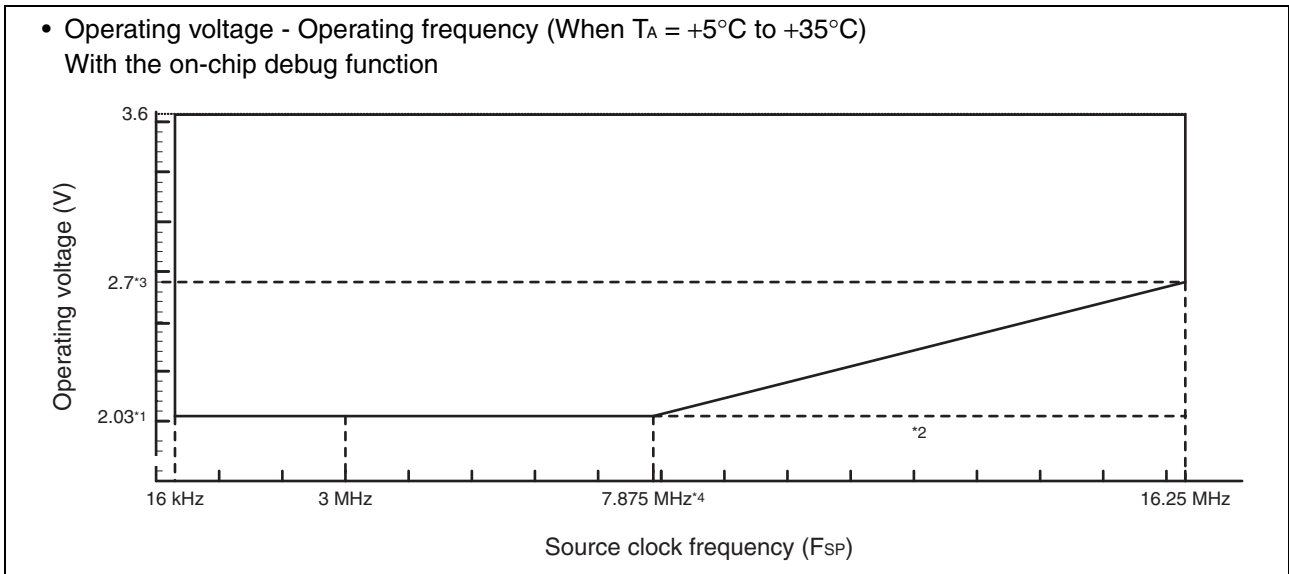

\*1: This is the default LVD reset clear threshold:  $1.93\text{ V} \pm 0.10\text{ V}$ . It can also be set to  $2.40\text{ V} \pm 0.15\text{ V}$  or  $2.95\text{ V} \pm 0.15\text{ V}$ .

\*2: If the LVD reset clear threshold is set to  $2.95\text{ V} \pm 0.15\text{ V}$ , the slope from 10 MHz to 16.25 MHz should be a horizontal line.

\*3: The operating voltage becomes 3.1 V if the LVD reset clear threshold is set to  $2.95\text{ V} \pm 0.15\text{ V}$ .

\*4: The source clock frequency becomes 14.375 MHz if the LVD reset clear threshold is set to  $2.40\text{ V} \pm 0.15\text{ V}$ .

# MB95310L/370L Series

## (3) External Reset

( $V_{CC} = 3.0 V \pm 10\%$ ,  $V_{SS} = 0.0 V$ ,  $T_A = -40^\circ C$  to  $+85^\circ C$ )

Parameter	Symbol	Value		Unit	Remarks
		Min	Max		
$\overline{RST}$ "L" level pulse width	$t_{RSTL}$	$2 t_{MCLK}^{*1}$	—	ns	In normal operation
		Oscillation time of the oscillator <sup>*2</sup> + 100	—	$\mu s$	In stop mode, subclock mode, subsleep mode, watch mode, and power-on
		100	—	$\mu s$	In time-base timer mode

\*1: See "(2) Source Clock/Machine Clock" for  $t_{MCLK}$ .

\*2: The oscillation time of an oscillator is the time for it to reach 90% of its amplitude. The crystal oscillator has an oscillation time of between several ms and tens of ms. The ceramic oscillator has an oscillation time of between hundreds of  $\mu s$  and several ms. The external clock has an oscillation time of 0 ms. The CR oscillator clock has an oscillation time of between several  $\mu s$  and several ms.

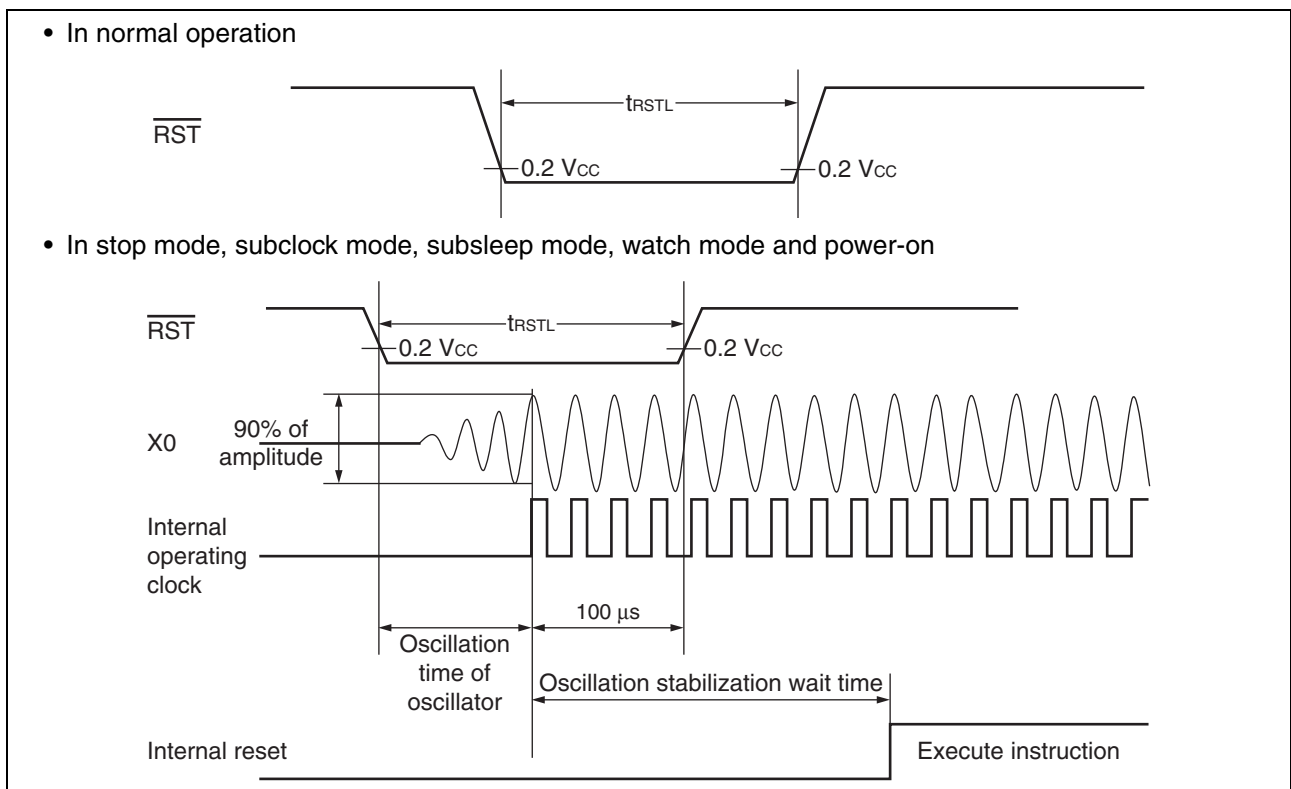

## (4) Power-on Reset

( $V_{SS} = 0.0\text{ V}$ ,  $T_A = -40^\circ\text{C}$  to  $+85^\circ\text{C}$ )

Parameter	Symbol	Condition	Value		Unit	Remarks
			Min	Max		
Power supply rising time	$t_R$	—	—	50	ms	
Power supply cutoff time	$t_{OFF}$	—	1	—	ms	Wait time until power-on

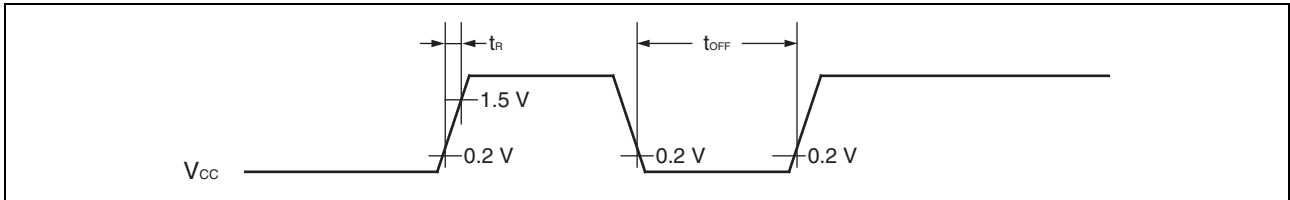

Note: A sudden change of power supply voltage may activate the power-on reset function. When changing the power supply voltage during the operation, set the slope of rising to a value below within 20 mV/ms as shown below.

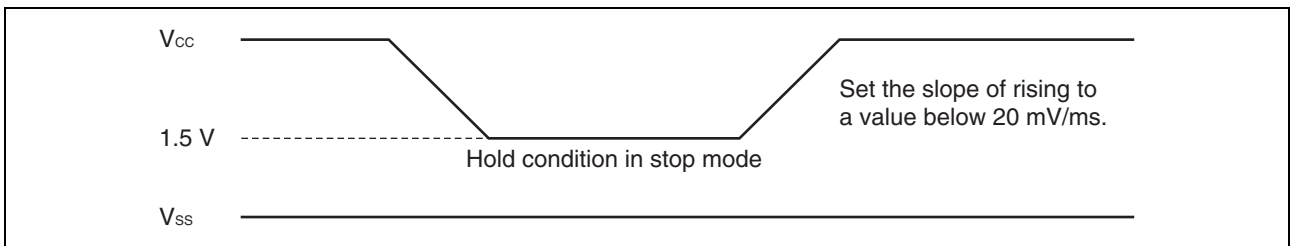

# MB95310L/370L Series

## (5) Peripheral Input Timing

( $V_{CC} = 3.0\text{ V} \pm 10\%$ ,  $V_{SS} = 0.0\text{ V}$ ,  $T_A = -40^\circ\text{C}$  to  $+85^\circ\text{C}$ )

Parameter	Symbol	Pin name	Value		Unit
			Min	Max	
Peripheral input "H" pulse width	$t_{LH}$	INT00 to INT07, EC0, EC1, ADTG	$2 t_{MCLK}^*$	—	ns
Peripheral input "L" pulse width	$t_{HL}$		$2 t_{MCLK}^*$	—	ns

\*: See "(2) Source Clock/Machine Clock" for  $t_{MCLK}$ .

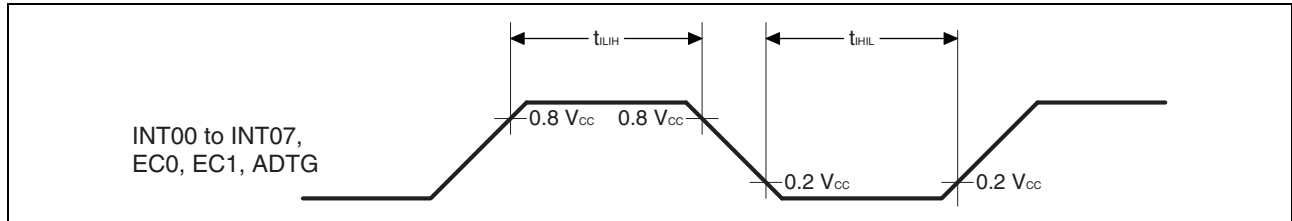



# MB95310L/370L Series

## (6) UART/SIO, Serial I/O Timing

( $V_{CC} = 3.0 V \pm 10\%$ ,  $AV_{SS} = V_{SS} = 0.0 V$ ,  $T_A = -40^\circ C$  to  $+85^\circ C$ )

Parameter	Symbol	Pin name	Condition	Value		Unit
				Min	Max	
Serial clock cycle time	$t_{SCYC}$	UCK0, UCK1	Internal clock operation output pin: $C_L = 80 \text{ pF} + 1 \text{ TTL}$	$4 t_{MCLK}^*$	—	ns
UCK ↓ → UO time	$t_{SLOVI}$	UCK0, UCK1, UO0, UO1		-190	+190	ns
Valid UI → UCK ↑	$t_{IVSHI}$	UCK0, UCK1, UI0, UI1		$2 t_{MCLK}^*$	—	ns
UCK ↑ → valid UI hold time	$t_{SHIXI}$	UCK0, UCK1, UI0, UI1		$2 t_{MCLK}^*$	—	ns
Serial clock "H" pulse width	$t_{SHSL}$	UCK0, UCK1	External clock operation output pin: $C_L = 80 \text{ pF} + 1 \text{ TTL}$	$4 t_{MCLK}^*$	—	ns
Serial clock "L" pulse width	$t_{SLSH}$	UCK0, UCK1		$4 t_{MCLK}^*$	—	ns
UCK ↓ → UO time	$t_{SLOVE}$	UCK0, UCK1, UO0, UO1		—	190	ns
Valid UI → UCK ↑	$t_{IVSHE}$	UCK0, UCK1, UI0, UI1		$2 t_{MCLK}^*$	—	ns
UCK ↑ → valid UI hold time	$t_{SHIXE}$	UCK0, UCK1, UI0, UI1		$2 t_{MCLK}^*$	—	ns

\*: See "(2) Source Clock/Machine Clock" for  $t_{MCLK}$ .

### • Internal shift clock mode

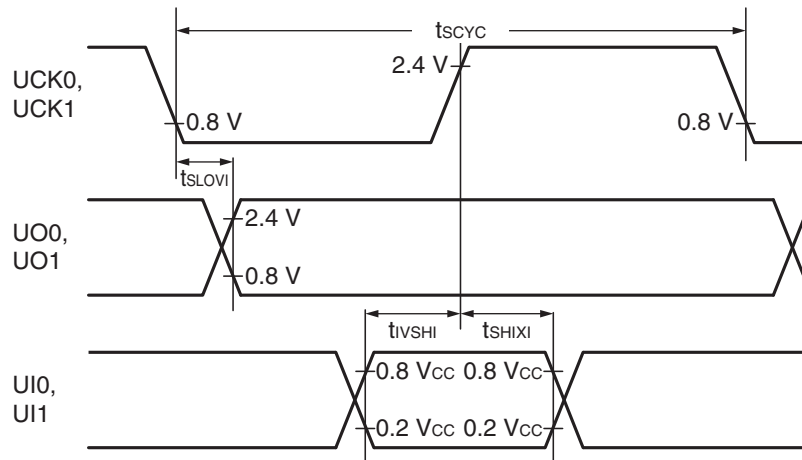

### • External shift clock mode

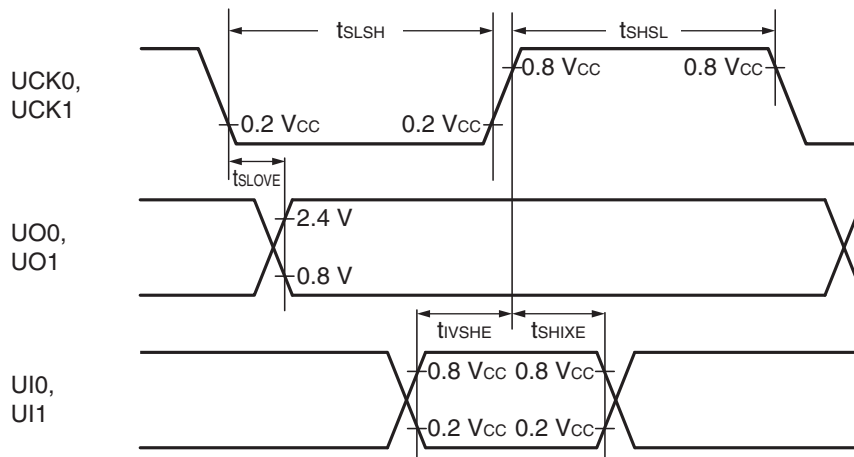

# MB95310L/370L Series

## (7) Low-voltage Detection

( $V_{SS} = 0.0 \text{ V}$ ,  $V_{CC} = 1.8 \text{ V to } 3.6 \text{ V}$ ,  $T_A = -40^\circ\text{C to } +85^\circ\text{C}$ )

Parameter	Symbol	Value			Unit	Remarks
		Min	Typ	Max		
Power release voltage 0	$V_{PDL0+}$	1.83	1.93	2.03	V	At power supply rise
Power detection voltage 0	$V_{PDL0-}$	1.80	1.90	2.00	V	At power supply fall
Power release voltage 1	$V_{PDL1+}$	2.25	2.40	2.55	V	At power supply rise
Power detection voltage 1	$V_{PDL1-}$	2.20	2.35	2.50	V	At power supply fall
Power release voltage 2	$V_{PDL2+}$	2.80	2.95	3.10	V	At power supply rise
Power detection voltage 2	$V_{PDL2-}$	2.70	2.85	3.00	V	At power supply fall
Interrupt release voltage 0	$V_{IDL0+}$	2.03	2.18	2.33	V	At power supply rise
Interrupt detection voltage 0	$V_{IDL0-}$	2.00	2.15	2.30	V	At power supply fall
Interrupt release voltage 1	$V_{IDL1+}$	2.25	2.40	2.55	V	At power supply rise
Interrupt detection voltage 1	$V_{IDL1-}$	2.20	2.35	2.50	V	At power supply fall
Interrupt release voltage 2	$V_{IDL2+}$	2.46	2.61	2.76	V	At power supply rise
Interrupt detection voltage 2	$V_{IDL2-}$	2.40	2.55	2.70	V	At power supply fall
Interrupt release voltage 3	$V_{IDL3+}$	2.67	2.82	2.97	V	At power supply rise
Interrupt detection voltage 3	$V_{IDL3-}$	2.60	2.75	2.90	V	At power supply fall
Interrupt release voltage 4	$V_{IDL4+}$	2.90	3.10	3.30	V	At power supply rise
Interrupt detection voltage 4	$V_{IDL4-}$	2.80	3.00	3.20	V	At power supply fall
Power supply start voltage	$V_{off}$	—	—	1.8	V	
Power supply end voltage	$V_{on}$	3.3	—	—	V	
Power supply voltage change time (at power supply rise)	$t_r$	3000	—	—	$\mu\text{s}$	Slope of power supply that the reset release signal generates within the rating ( $V_{PDL+}/V_{IDL+}$ )
Power supply voltage change time (at power supply fall)	$t_f$	3000	—	—	$\mu\text{s}$	Slope of power supply that the reset detection signal generates within the rating ( $V_{PDL-}/V_{IDL-}$ )

(Continued)

# MB95310L/370L Series

(Continued)

( $V_{SS} = 0.0\text{ V}$ ,  $V_{CC} = 1.8\text{ V to }3.6\text{ V}$ ,  $T_A = -40^\circ\text{C to }+85^\circ\text{C}$ )

Parameter	Symbol	Value			Unit	Remarks
		Min	Typ	Max		
Power reset release delay time	$t_{dp1}$	10	—	300	$\mu\text{s}$	
Power reset detection delay time	$t_{dp2}$	—	—	150	$\mu\text{s}$	
Interrupt reset release delay time	$t_{di1}$	10	—	200	$\mu\text{s}$	
Interrupt reset detection delay time	$t_{di2}$	—	—	150	$\mu\text{s}$	

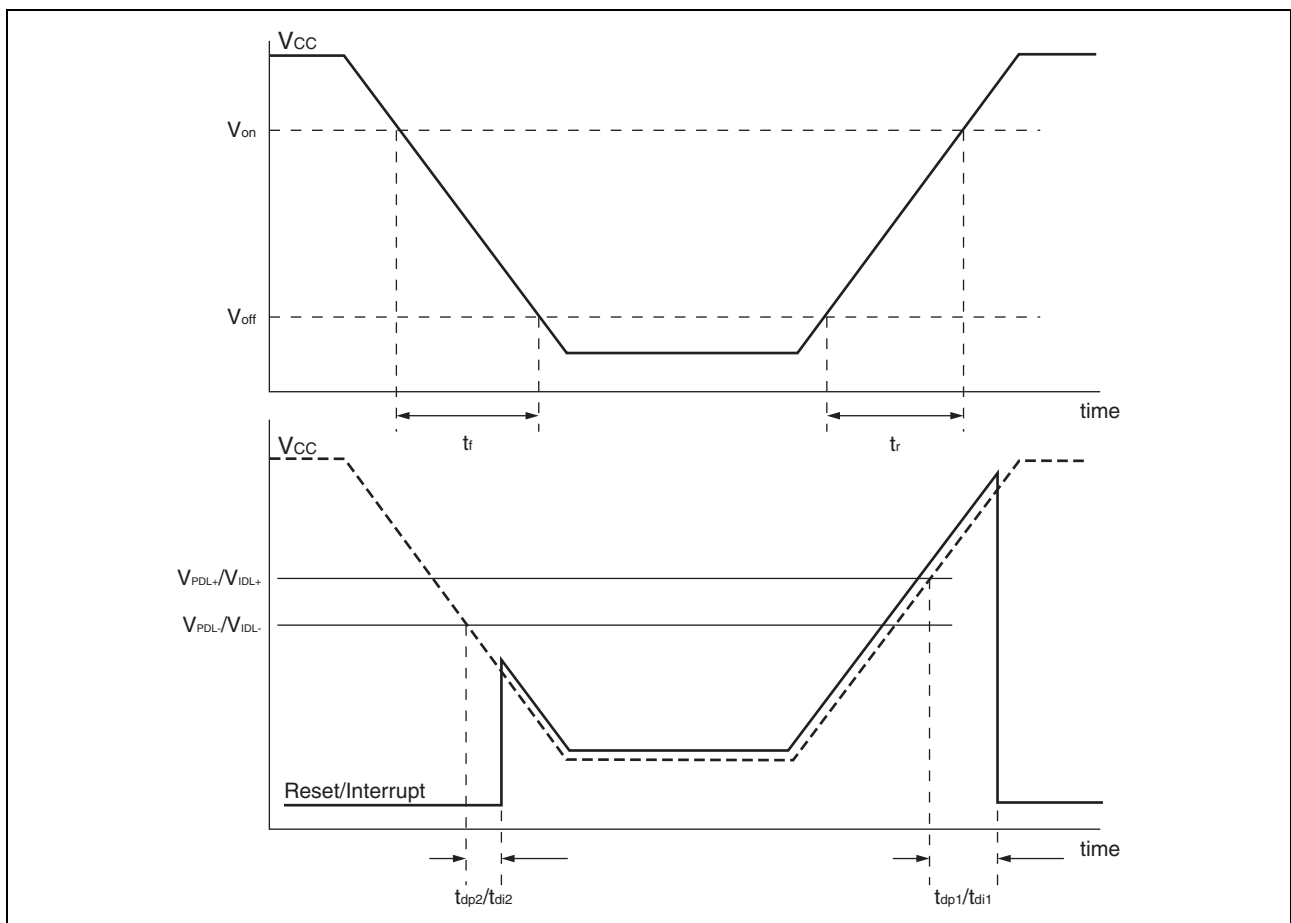

# MB95310L/370L Series

## (8) I<sup>2</sup>C Timing

(V<sub>CC</sub> = 3.0 V ± 10%, AV<sub>SS</sub> = V<sub>SS</sub> = 0.0 V, T<sub>A</sub> = -40°C to +85°C)

Parameter	Symbol	Pin name	Conditions	Value				Unit
				Standard-mode		Fast-mode		
				Min	Max	Min	Max	
SCL clock frequency	f <sub>SCL</sub>	SCL0	R = 1.7 kΩ, C = 50 pF*1	0	100	0	400	kHz
(Repeat) Start condition hold time SDA ↓ → SCL ↓	t <sub>HD,STA</sub>	SCL0, SDA0		4.0	—	0.6	—	μs
SCL clock "L" width	t <sub>LOW</sub>	SCL0		4.7	—	1.3	—	μs
SCL clock "H" width	t <sub>HIGH</sub>	SCL0		4.0	—	0.6	—	μs
(Repeat) Start condition setup time SCL ↑ → SDA ↓	t <sub>SU,STA</sub>	SCL0, SDA0		4.7	—	0.6	—	μs
Data hold time SCL ↓ → SDA ↓ ↑	t <sub>HD,DAT</sub>	SCL0, SDA0		0	3.45*2	0	0.9*3	μs
Data setup time SDA ↓ ↑ → SCL ↑	t <sub>SU,DAT</sub>	SCL0, SDA0		0.25	—	0.1	—	μs
Stop condition setup time SCL ↑ → SDA ↑	t <sub>SU,STO</sub>	SCL0, SDA0		4.0	—	0.6	—	μs
Bus free time between stop condition and start condition	t <sub>BUF</sub>	SCL0, SDA0		4.7	—	1.3	—	μs

\*1: R represents the pull-up resistor of the SCL0 and SDA0 lines, and C the load capacitor of the SCL0 and SDA0 lines.

\*2: The maximum t<sub>HD,DAT</sub> in the Standard-mode is applicable only when the time during which the device is holding the SCL signal at "L" (t<sub>LOW</sub>) does not extend.

\*3: A Fast-mode I<sup>2</sup>C-bus device can be used in a Standard-mode I<sup>2</sup>C-bus system, provided that the condition of t<sub>SU,DAT</sub> ≥ 250 ns is fulfilled.

(Continued)

(Continued)

Note: The rating of the input data set-up time in the device connected to the bus cannot be satisfied depending on the load capacitance or pull-up resistor.

Be sure to adjust the pull-up resistor of SDA0 and SCL0 if the rating of the input data set-up time cannot be satisfied.

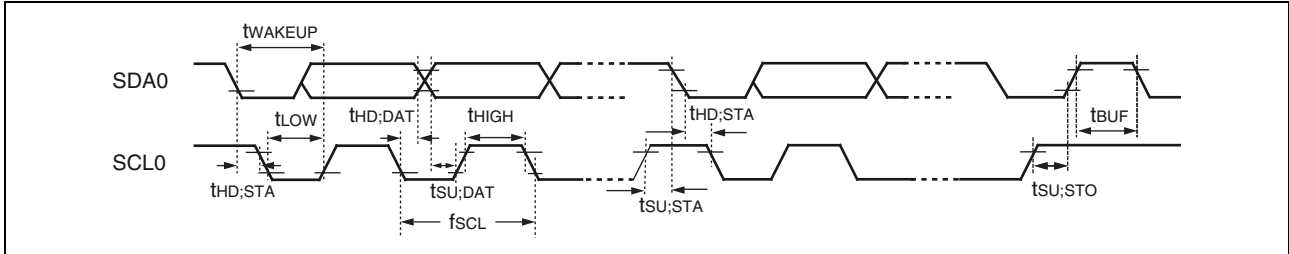

# MB95310L/370L Series

( $V_{CC} = 3.0 V \pm 10\%$ ,  $AV_{SS} = V_{SS} = 0.0 V$ ,  $T_A = -40^\circ C$  to  $+85^\circ C$ )

Parameter	Symbol	Pin name	Conditions	Value*2		Unit	Remarks
				Min	Max		
SCL clock "L" width	$t_{LOW}$	SCL0	R = 1.7 k $\Omega$ , C = 50 pF*1	$(2 + nm / 2) t_{MCLK} - 20$	—	ns	Master mode
SCL clock "H" width	$t_{HIGH}$	SCL0		$(nm / 2) t_{MCLK} - 20$	$(nm / 2) t_{MCLK} + 20$	ns	Master mode
Start condition hold time	$t_{HD,STA}$	SCL0, SDA0		$(-1 + nm / 2) t_{MCLK} - 20$	$(-1 + nm) t_{MCLK} + 20$	ns	Master mode Maximum value is applied when m, n = 1, 8. Otherwise, the minimum value is applied.
Stop condition setup time	$t_{SU,STO}$	SCL0, SDA0		$(1 + nm / 2) t_{MCLK} - 20$	$(1 + nm / 2) t_{MCLK} + 20$	ns	Master mode
Start condition setup time	$t_{SU,STA}$	SCL0, SDA0		$(1 + nm / 2) t_{MCLK} - 20$	$(1 + nm / 2) t_{MCLK} + 20$	ns	Master mode
Bus free time between stop condition and start condition	$t_{BUF}$	SCL0, SDA0		$(2 nm + 4) t_{MCLK} - 20$	—	ns	
Data hold time	$t_{HD,DAT}$	SCL0, SDA0		$3 t_{MCLK} - 20$	—	ns	Master mode
Data setup time	$t_{SU,DAT}$	SCL0, SDA0		$(-2 + nm / 2) t_{MCLK} - 20$	$(-1 + nm / 2) t_{MCLK} + 20$	ns	Master mode When assuming that "L" of SCL is not extended, the minimum value is applied to first bit of continuous data. Otherwise, the maximum value is applied.

(Continued)

# MB95310L/370L Series

( $V_{CC} = 3.0 V \pm 10\%$ ,  $AV_{SS} = V_{SS} = 0.0 V$ ,  $T_A = -40^\circ C$  to  $+85^\circ C$ )

Parameter	Symbol	Pin name	Conditions	Value*2		Unit	Remarks
				Min	Max		
Setup time between clearing interrupt and SCL rising	$t_{SU,INT}$	SCL0	R = 1.7 k $\Omega$ , C = 50 pF*1	$(nm / 2)t_{MCLK} - 20$	$(1 + nm / 2)t_{MCLK} + 20$	ns	Minimum value is applied to interrupt at 9th SCL $\downarrow$ . Maximum value is applied to interrupt at 8th SCL $\downarrow$ .
SCL clock "L" width	$t_{LOW}$	SCL0		$4 t_{MCLK} - 20$	—	ns	At reception
SCL clock "H" width	$t_{HIGH}$	SCL0		$4 t_{MCLK} - 20$	—	ns	At reception
Start condition detection	$t_{HD,STA}$	SCL0, SDA0		$2 t_{MCLK} - 20$	—	ns	Not detected when 1 $t_{MCLK}$ is used at reception
Stop condition detection	$t_{SU,STO}$	SCL0, SDA0		$2 t_{MCLK} - 20$	—	ns	Not detected when 1 $t_{MCLK}$ is used at reception
Restart condition detection condition	$t_{SU,STA}$	SCL0, SDA0		$2 t_{MCLK} - 20$	—	ns	Not detected when 1 $t_{MCLK}$ is used at reception
Bus free time	$t_{BUF}$	SCL0, SDA0		$2 t_{MCLK} - 20$	—	ns	At reception
Data hold time	$t_{HD,DAT}$	SCL0, SDA0		$2 t_{MCLK} - 20$	—	ns	At slave transmission mode
Data setup time	$t_{SU,DAT}$	SCL0, SDA0		$t_{LOW} - 3 t_{MCLK} - 20$	—	ns	At slave transmission mode
Data hold time	$t_{HD,DAT}$	SCL0, SDA0		0	—	ns	At reception
Data setup time	$t_{SU,DAT}$	SCL0, SDA0		$t_{MCLK} - 20$	—	ns	At reception
SDA $\downarrow \rightarrow$ SCL $\uparrow$ (at wakeup function)	$t_{WAKEUP}$	SCL0, SDA0		Oscillation stabilization wait time + $2 t_{MCLK} - 20$	—	ns	

(Continued)

(Continued)

\*1: R represents the pull-up resistor of the SCL0 and SDA0 lines, and C the load capacitor of the SCL0 and SDA0 lines.

\*2: • See “(2) Source Clock/Machine Clock” for  $t_{MCLK}$ .

- m represents the CS4 bit and CS3 bit (bit4 and bit3) in the I<sup>2</sup>C clock control register (ICCR0).
- n represents the CS2 bit to CS0 bit (bit2 to bit0) in the I<sup>2</sup>C clock control register (ICCR0).
- The actual timing of I<sup>2</sup>C is determined by the values of m and n set by the machine clock ( $t_{MCLK}$ ) and the CS4 to CS0 bits in the ICCR0 register.

• Standard-mode:

m and n can be set to values in the following range:  $0.9 \text{ MHz} < t_{MCLK} \text{ (machine clock)} < 16.25 \text{ MHz}$ .

The usable frequencies of the machine clock are determined by the settings of m and n as shown below.

(m, n) = (1, 8)	: $0.9 \text{ MHz} < t_{MCLK} \leq 1 \text{ MHz}$
(m, n) = (1, 22), (5, 4), (6, 4), (7, 4), (8, 4)	: $0.9 \text{ MHz} < t_{MCLK} \leq 2 \text{ MHz}$
(m, n) = (1, 38), (5, 8), (6, 8), (7, 8), (8, 8)	: $0.9 \text{ MHz} < t_{MCLK} \leq 4 \text{ MHz}$
(m, n) = (1, 98), (5, 22), (6, 22), (7, 22)	: $0.9 \text{ MHz} < t_{MCLK} \leq 10 \text{ MHz}$
(m, n) = (8, 22)	: $0.9 \text{ MHz} < t_{MCLK} \leq 16.25 \text{ MHz}$

• Fast-mode:

m and n can be set to values in the following range:  $3.3 \text{ MHz} < t_{MCLK} \text{ (machine clock)} < 16.25 \text{ MHz}$ .

The usable frequencies of the machine clock are determined by the settings of m and n as shown below.

(m, n) = (1, 8)	: $3.3 \text{ MHz} < t_{MCLK} \leq 4 \text{ MHz}$
(m, n) = (1, 22), (5, 4)	: $3.3 \text{ MHz} < t_{MCLK} \leq 8 \text{ MHz}$
(m, n) = (1, 38), (6, 4), (7, 4), (8, 4)	: $3.3 \text{ MHz} < t_{MCLK} \leq 10 \text{ MHz}$
(m, n) = (5, 8)	: $3.3 \text{ MHz} < t_{MCLK} \leq 16.25 \text{ MHz}$



# MB95310L/370L Series

## 5. A/D Converter

### (1) A/D Converter Electrical Characteristics

( $V_{CC} = 1.8\text{ V to }3.6\text{ V}$ ,  $V_{SS} = 0.0\text{ V}$ ,  $T_A = -40^\circ\text{C to }+85^\circ\text{C}$ )

Parameter	Symbol	Value			Unit	Remarks
		Min	Typ	Max		
Resolution	—	—	—	10	bit	
Total error		-3	—	+3	LSB	
Linearity error		-2.5	—	+2.5	LSB	
Differential linear error		-1.9	—	+1.9	LSB	
Zero transition voltage	$V_{OT}$	$AV_{SS} - 1.5\text{ LSB}$	$AV_{SS} + 0.5\text{ LSB}$	$AV_{SS} + 2.5\text{ LSB}$	V	$2.7\text{ V} \leq V_{CC} \leq 3.6\text{ V}$
		$AV_{SS} - 0.5\text{ LSB}$	$AV_{SS} + 1.5\text{ LSB}$	$AV_{SS} + 3.5\text{ LSB}$	V	$1.8\text{ V} \leq V_{CC} < 2.7\text{ V}$
Full-scale transition voltage	$V_{FST}$	$AV_{CC} - 3.5\text{ LSB}$	$AV_{CC} - 1.5\text{ LSB}$	$AV_{CC} + 0.5\text{ LSB}$	V	$2.7\text{ V} \leq V_{CC} \leq 3.6\text{ V}$
		$AV_{CC} - 2.5\text{ LSB}$	$AV_{CC} - 0.5\text{ LSB}$	$AV_{CC} + 1.5\text{ LSB}$	V	$1.8\text{ V} \leq V_{CC} < 2.7\text{ V}$
Compare time	—	0.6	—	140	$\mu\text{s}$	$2.7\text{ V} \leq V_{CC} \leq 3.6\text{ V}$
		20	—	140	$\mu\text{s}$	$1.8\text{ V} \leq V_{CC} < 2.7\text{ V}$
Sampling time	—	0.4	—	$\infty$	$\mu\text{s}$	$2.7\text{ V} \leq V_{CC} \leq 3.6\text{ V}$ , with external impedance $< 1.8\text{ k}\Omega$
		30	—	$\infty$	$\mu\text{s}$	$1.8\text{ V} \leq V_{CC} < 2.7\text{ V}$ , with external impedance $< 14.8\text{ k}\Omega$
Analog input current	$I_{AIN}$	-0.3	—	+0.3	$\mu\text{A}$	
Analog input voltage	$V_{AIN}$	$AV_{SS}$	—	$AV_{CC}$	V	

# MB95310L/370L Series

## (2) Notes on Using the A/D Converter

### • External impedance of analog input and its sampling time

- The A/D converter has a sample and hold circuit. If the external impedance is too high to keep sufficient sampling time, the analog voltage charged to the capacitor of the internal sample and hold circuit is insufficient, adversely affecting A/D conversion precision. Therefore, to satisfy the A/D conversion precision standard, considering the relationship between the external impedance and minimum sampling time, either adjust the register value and operating frequency or decrease the external impedance so that the sampling time is longer than the minimum value. In addition, if sufficient sampling time cannot be secured, connect a capacitor of about 0.1  $\mu\text{F}$  to the analog input pin.

### • Analog input equivalent circuit

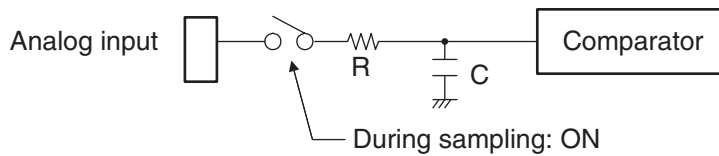

$V_{CC}$	R	C
$2.7 \text{ V} \leq V_{CC} \leq 3.6 \text{ V}$	1.7 k $\Omega$ (Max)	14.5 pF (Max)
$1.8 \text{ V} \leq V_{CC} < 2.7 \text{ V}$	8.4 k $\Omega$ (Max)	25.2 pF (Max)

Note: The values are reference values.

### • Relationship between external impedance and minimum sampling time

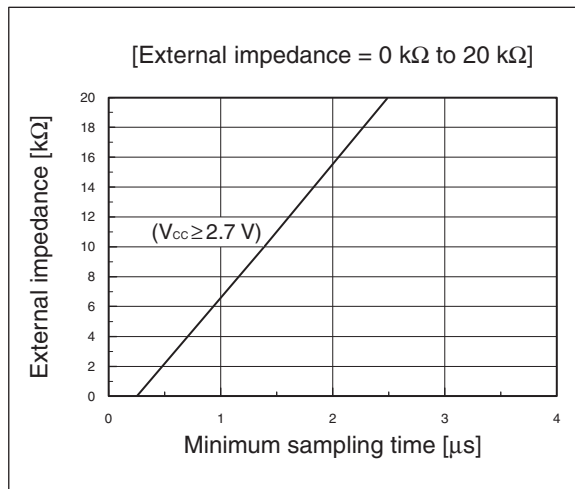
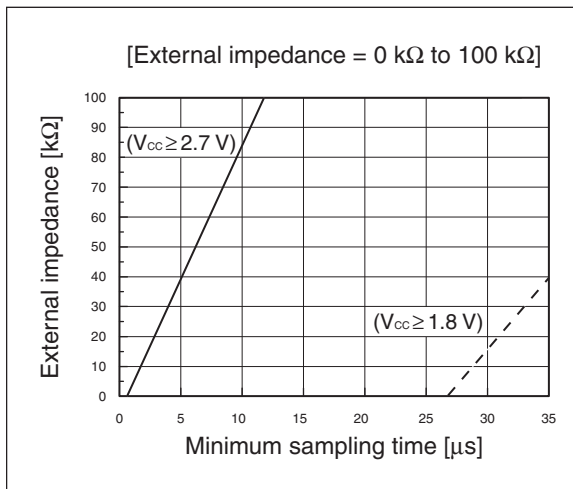

### • A/D conversion error

As  $V_{CC} - V_{SS1}$  decreases, the A/D conversion error increases proportionately.

### (3) Definitions of A/D Converter Terms

- Resolution  
It indicates the level of analog variation that can be distinguished by the A/D converter.  
When the number of bits is 10, analog voltage can be divided into  $2^{10} = 1024$ .
- Linearity error (unit: LSB)  
It indicates how much an actual conversion value deviates from the straight line connecting the zero transition point ("00 0000 0000" ← → "00 0000 0001") of a device to the full-scale transition point ("11 1111 1111" ← → "11 1111 1110") of the same device.
- Differential linear error (unit: LSB)  
It indicates how much the input voltage required to change the output code by 1 LSB deviates from an ideal value.
- Total error (unit: LSB)  
It indicates the difference between an actual value and a theoretical value. The error can be caused by a zero transition error, a full-scale transition errors, a linearity error, a quantum error, or noise.

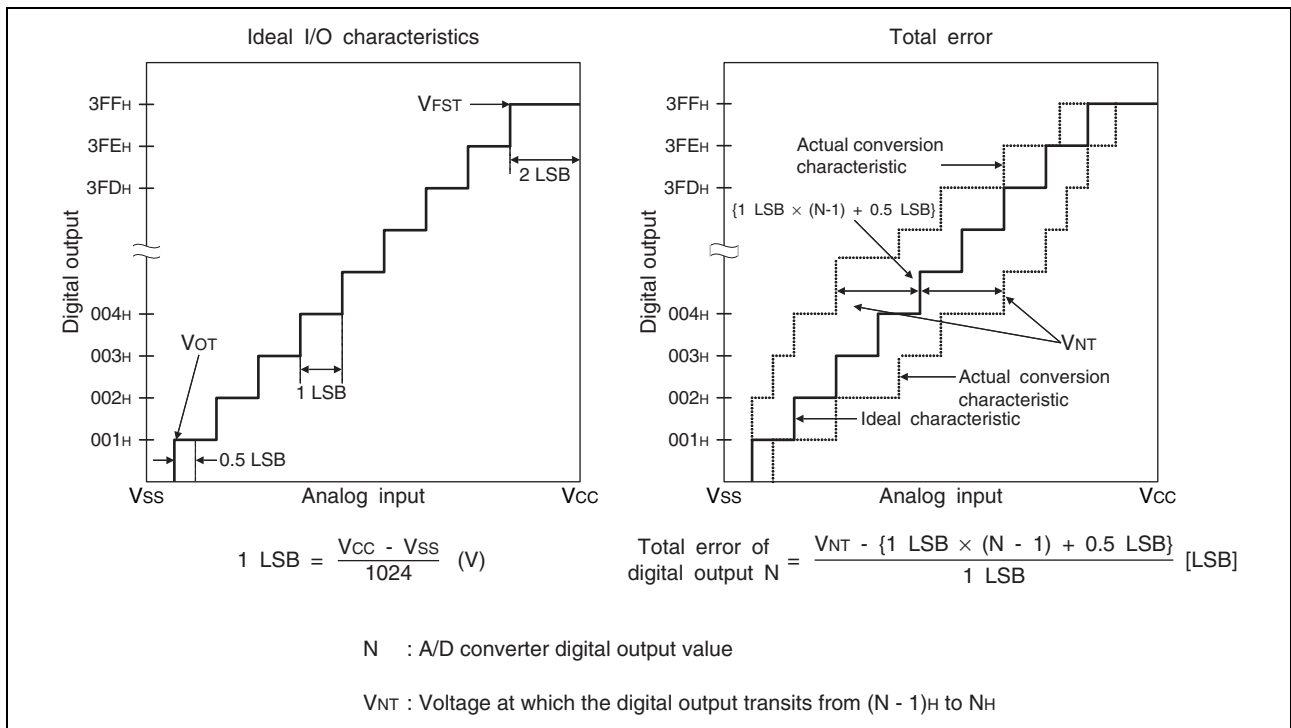

(Continued)

(Continued)

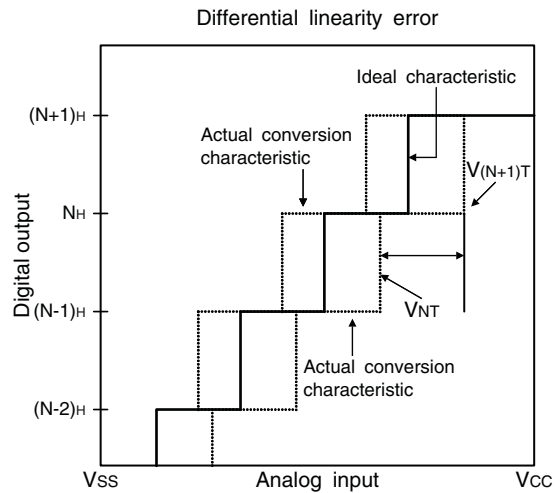
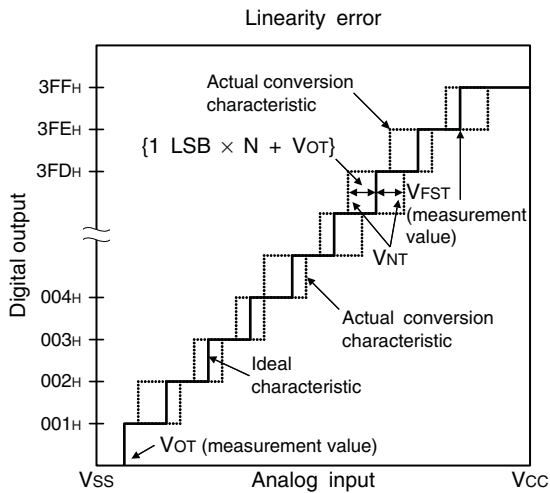
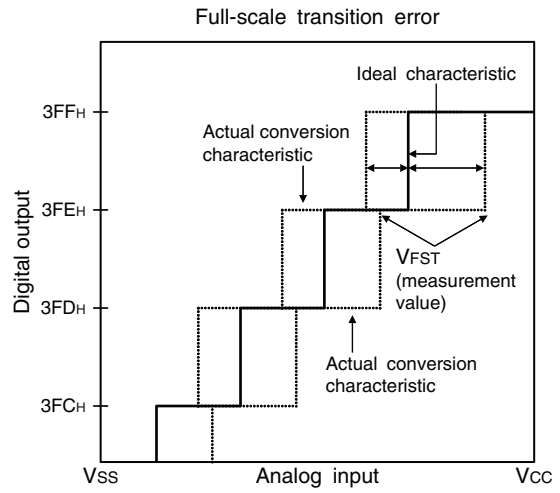
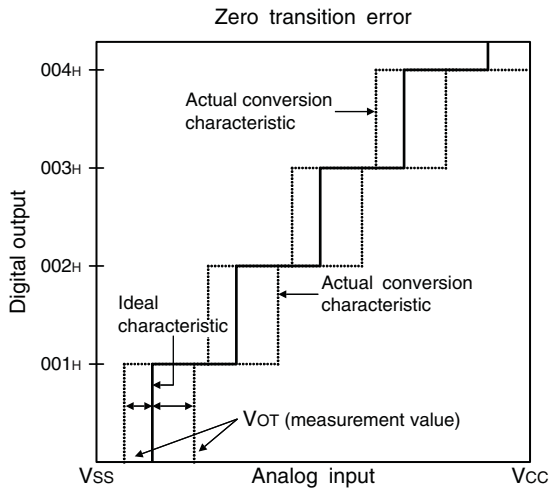

$$\text{Linearity error of digital output } N = \frac{V_{NT} - \{1 \text{ LSB} \times N + V_{OT}\}}{1 \text{ LSB}}$$

$$\text{Differential linear error of digital output } N = \frac{V_{(N+1)T} - V_{NT}}{1 \text{ LSB}} - 1$$

N : A/D converter digital output value

V<sub>NT</sub> : Voltage at which the digital output transits from (N - 1)<sub>H</sub> to N<sub>H</sub>

V<sub>OT</sub> (ideal value) = V<sub>ss</sub> + 0.5 LSB [V]

V<sub>FST</sub> (ideal value) = V<sub>cc</sub> - 2 LSB [V]

## 6. Flash Memory Program/Erase Characteristics

Parameter	Value			Unit	Remarks
	Min	Typ	Max		
Sector erase time (2 Kbyte sector)	—	0.2 <sup>*1</sup>	0.5 <sup>*2</sup>	s	The time of programming 00 <sub>H</sub> prior to erasure is excluded.
Sector erase time (16 Kbyte sector)	—	0.5 <sup>*1</sup>	7.5 <sup>*2</sup>	s	The time of programming 00 <sub>H</sub> prior to erasure is excluded.
Byte programming time	—	21	6100 <sup>*2</sup>	μs	System-level overhead is excluded.
Program/erase cycle	100000	—	—	cycle	
Power supply voltage at program/erase	2.7	3.0	3.6	V	
Flash memory data retention time	20 <sup>*3</sup>	—	—	year	Average T <sub>A</sub> = +85°C

\*1: T<sub>A</sub> = +25°C, V<sub>CC</sub> = 3.0 V, 100000 cycles

\*2: T<sub>A</sub> = +85°C, V<sub>CC</sub> = 2.7 V, 100000 cycles

\*3: This value is converted from the result of a technology reliability assessment. (The value is converted from the result of a high temperature accelerated test using the Arrhenius equation with the average temperature being +85°C).

# MB95310L/370L Series

## ■ SAMPLE CHARACTERISTICS

- Power supply current temperature characteristics

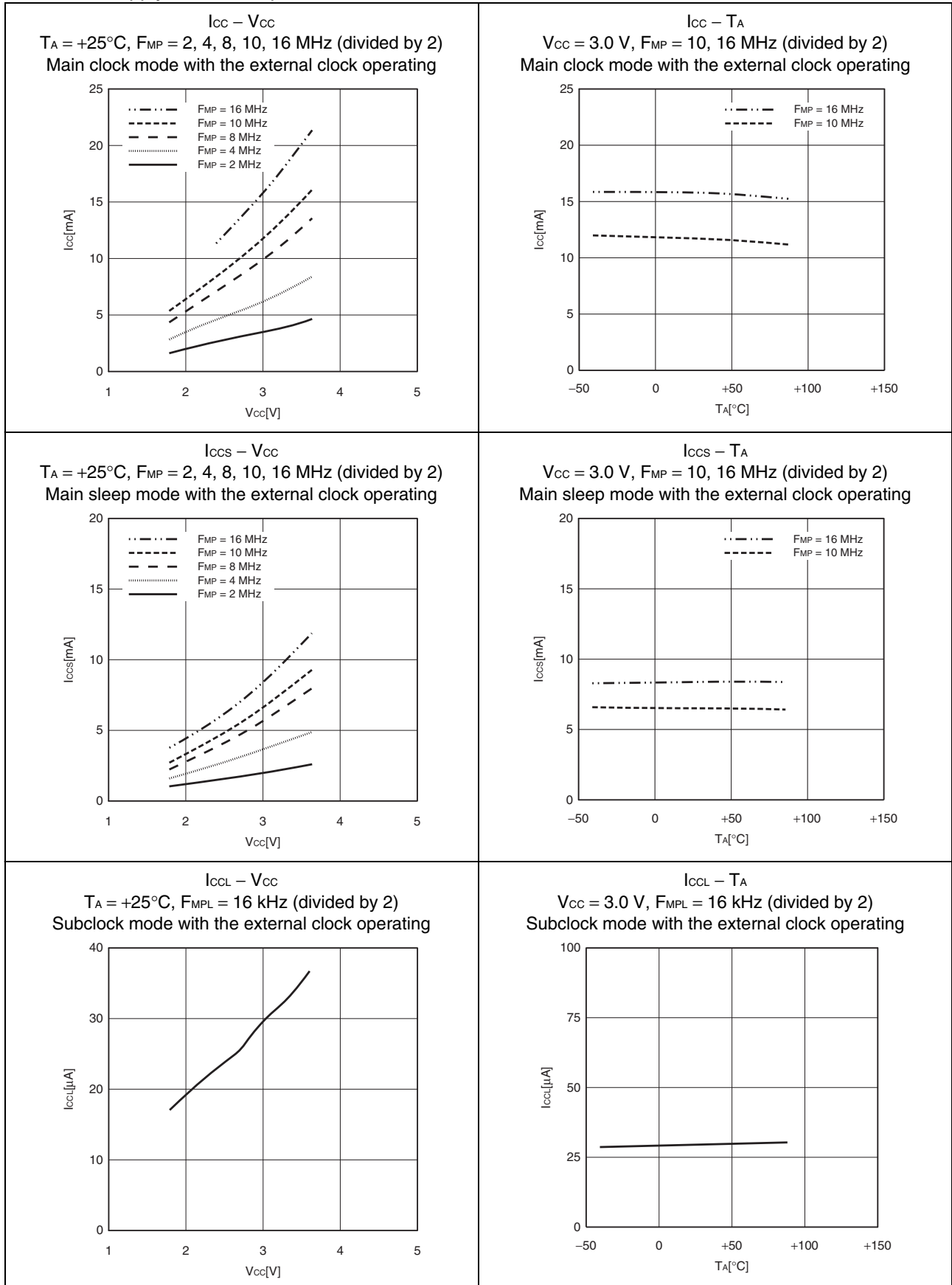

(Continued)

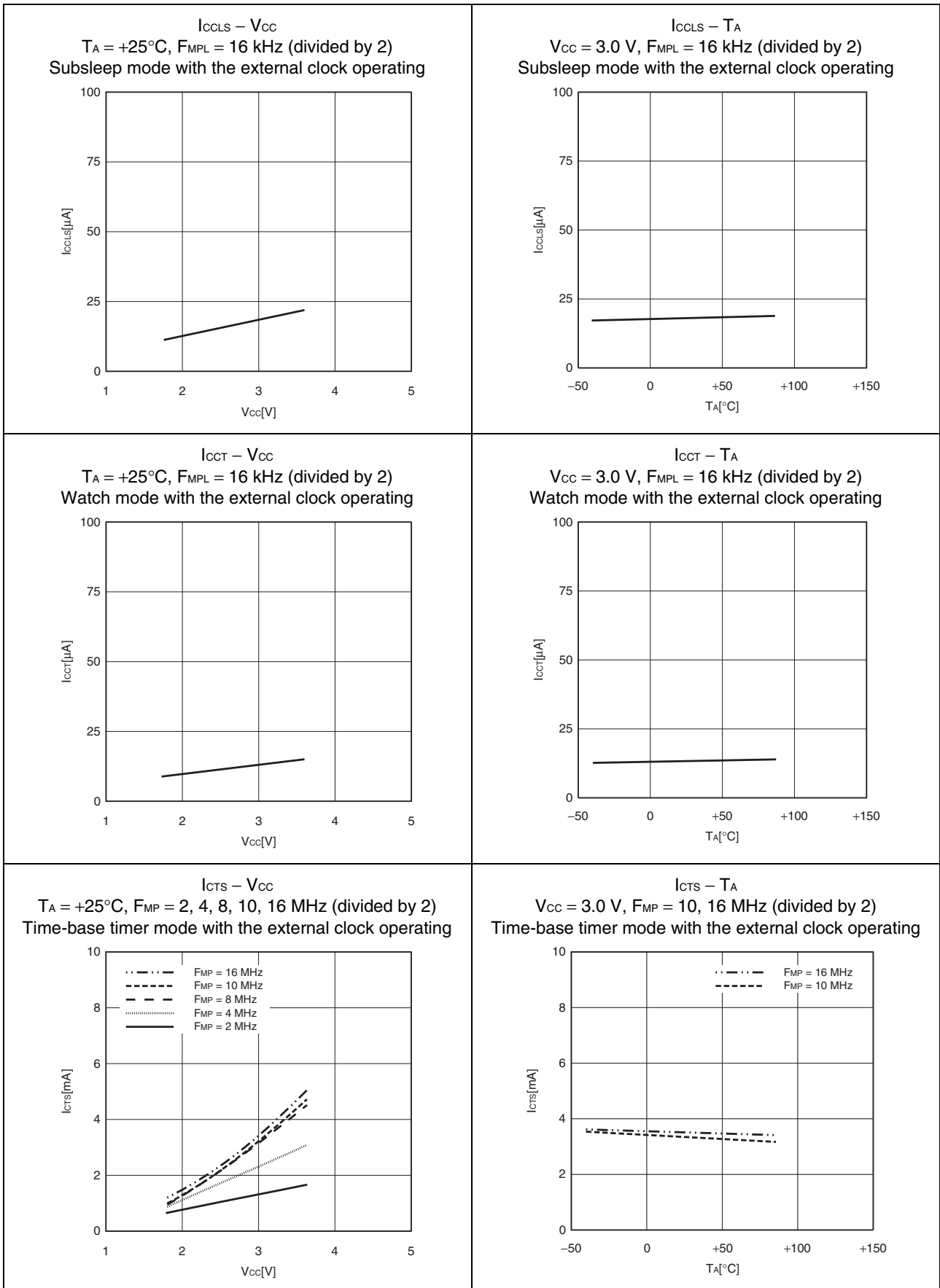

(Continued)

# MB95310L/370L Series

(Continued)

$I_{CCH} - V_{CC}$   
 $T_A = +25^\circ\text{C}$ ,  $F_{MPL} = (\text{stop})$   
 Substop mode with the external clock stopping

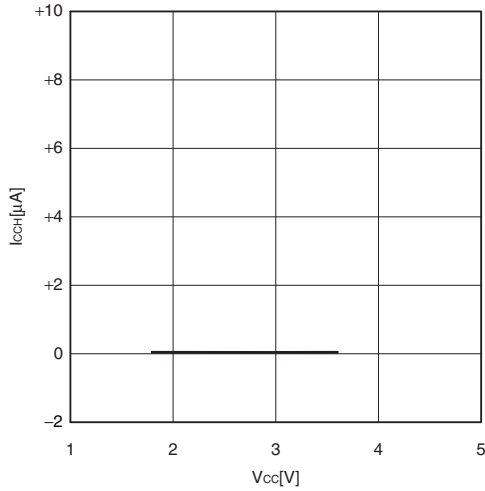

$I_{CCH} - T_A$   
 $V_{CC} = 3.0\text{ V}$ ,  $F_{MPL} = (\text{stop})$   
 Substop mode with the external clock stopping

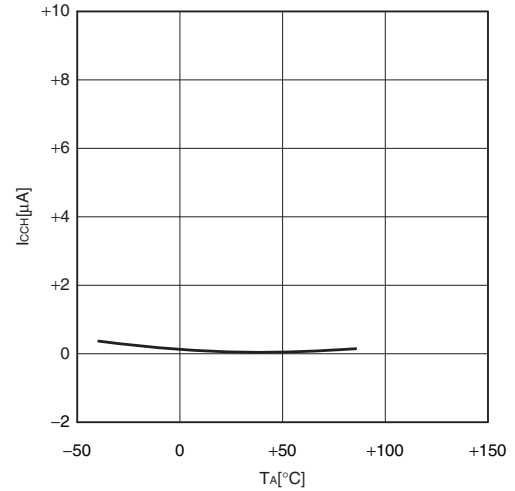

$I_{CCMCR} - V_{CC}$   
 $T_A = +25^\circ\text{C}$ ,  $F_{MP} = 1, 8, 10, 12.5\text{ MHz}$  (no division)  
 Main clock mode with the main CR clock operating

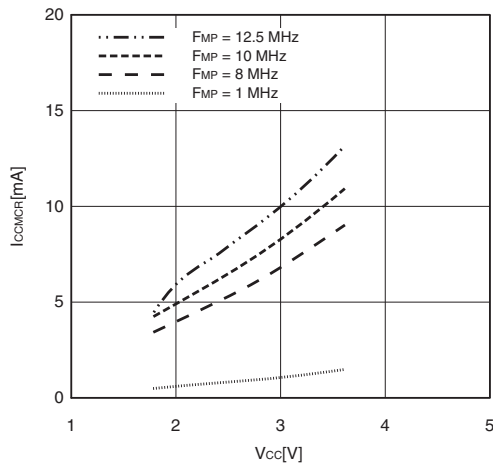

$I_{CCMCR} - T_A$   
 $V_{CC} = 3.0\text{ V}$ ,  $F_{MP} = 1, 8, 10, 12.5\text{ MHz}$  (no division)  
 Main clock mode with the main CR clock operating

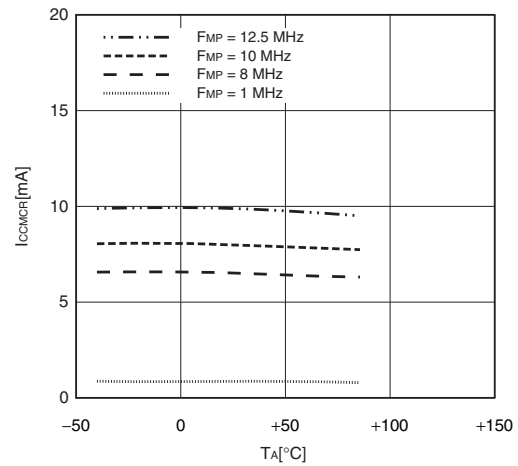

$I_{CCSCR} - V_{CC}$   
 $T_A = +25^\circ\text{C}$ ,  $F_{MPL} = 50\text{ kHz}$  (divided by 2)  
 Subclock mode with the sub-CR clock operating

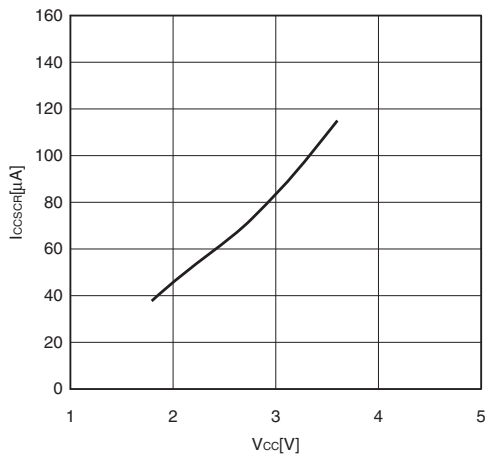

$I_{CCSCR} - T_A$   
 $V_{CC} = 3.0\text{ V}$ ,  $F_{MPL} = 50\text{ kHz}$  (divided by 2)  
 Subclock mode with the sub-CR clock operating

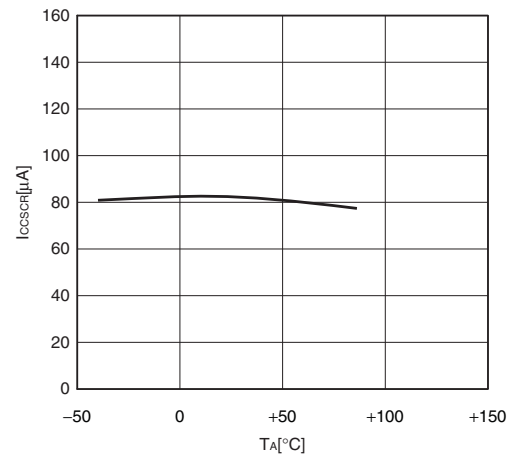



• Input voltage characteristics

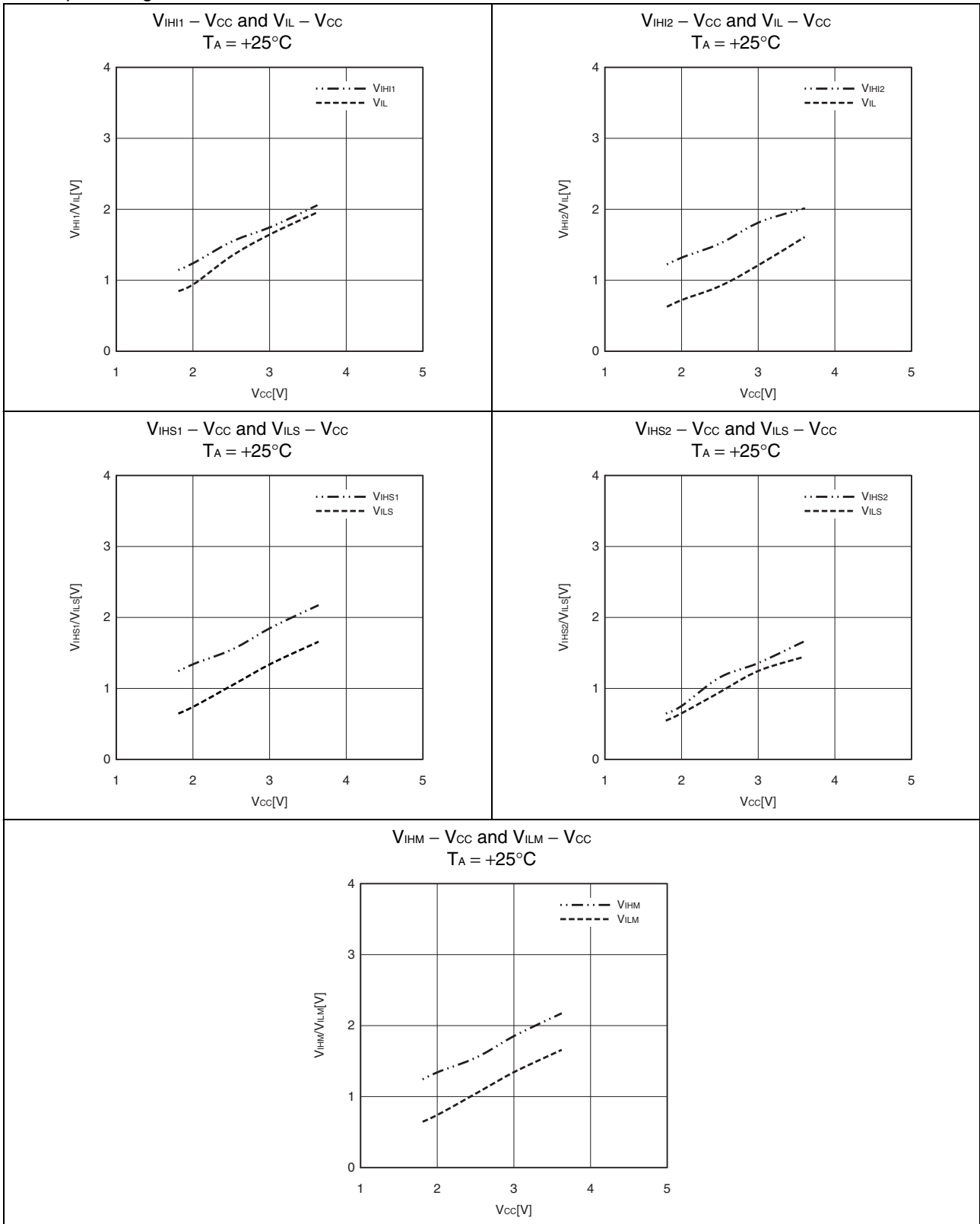

# MB95310L/370L Series

- Output voltage characteristics

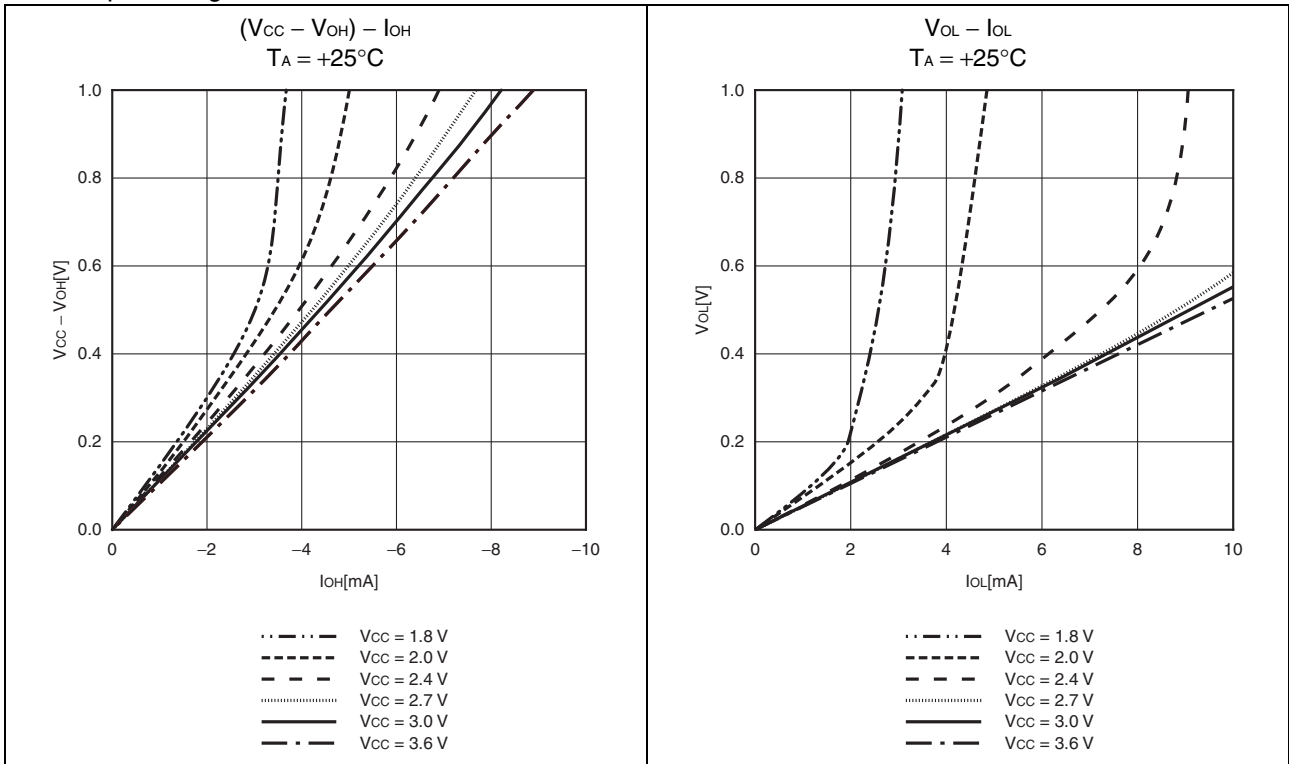

- Pull-up characteristics

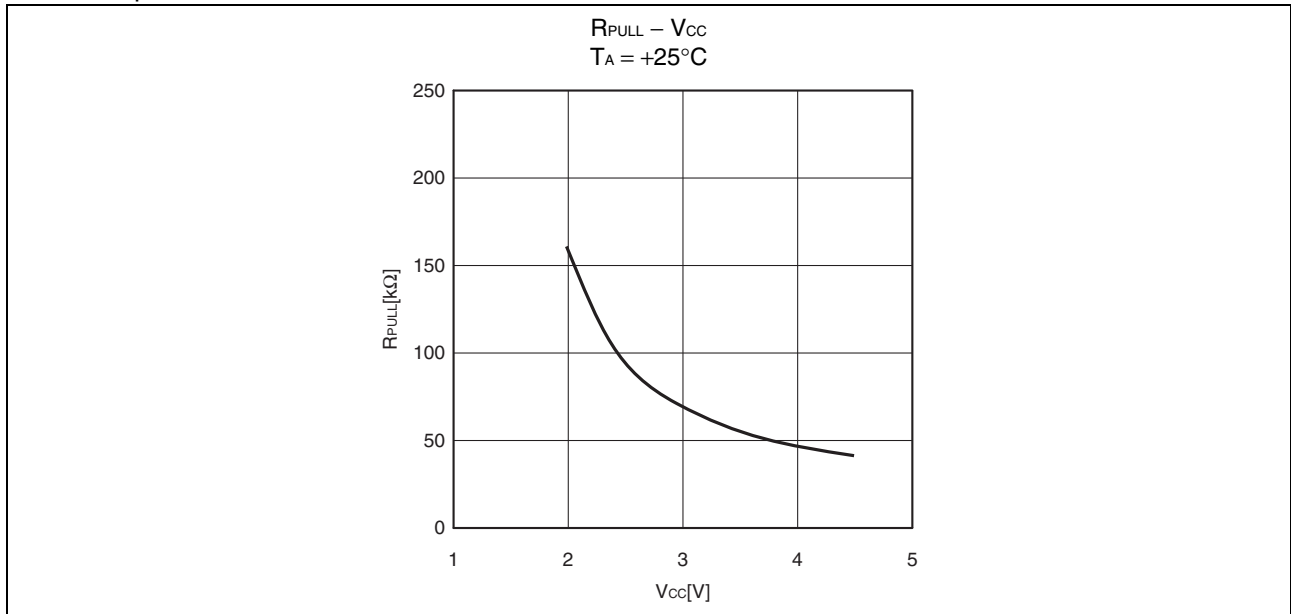

# MB95310L/370L Series

## ■ MASK OPTIONS

No.	Part Number	MB95F314E MB95F316E MB95F318E MB95F374E MB95F376E MB95F378E	MB95F314L MB95F316L MB95F318L MB95F374L MB95F376L MB95F378L
	Selectable/Fixed	Fixed	
1	Low-voltage detection reset	With low-voltage detection reset	Without low-voltage detection reset

# MB95310L/370L Series

## ■ ORDERING INFORMATION

Part Number	Package
MB95F314EPMC-G-SNE2 MB95F314LPMC-G-SNE2 MB95F316EPMC-G-SNE2 MB95F316LPMC-G-SNE2 MB95F318EPMC-G-SNE2 MB95F318LPMC-G-SNE2	80-pin plastic LQFP (FPT-80P-M37)
MB95F374EPMC1-G-SNE2 MB95F374LPMC1-G-SNE2 MB95F376EPMC1-G-SNE2 MB95F376LPMC1-G-SNE2 MB95F378EPMC1-G-SNE2 MB95F378LPMC1-G-SNE2	64-pin plastic LQFP (FPT-64P-M38)
MB95F374EPMC2-G-SNE2 MB95F374LPMC2-G-SNE2 MB95F376EPMC2-G-SNE2 MB95F376LPMC2-G-SNE2 MB95F378EPMC2-G-SNE2 MB95F378LPMC2-G-SNE2	64-pin plastic LQFP (FPT-64P-M39)

# MB95310L/370L Series

## PACKAGE DIMENSION

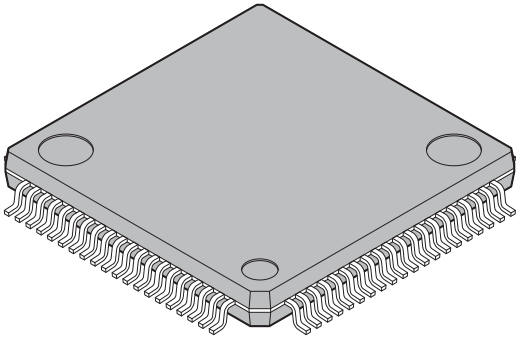
 <p>80-pin plastic LQFP</p> <p>(FPT-80P-M37)</p>	Lead pitch	0.50 mm
	Package width package length	12.00 mm 12.00 mm
	Lead shape	Gullwing
	Lead bend direction	Normal bend
	Sealing method	Plastic mold
	Mounting height	1.70 mm MAX
	Weight	0.47 g

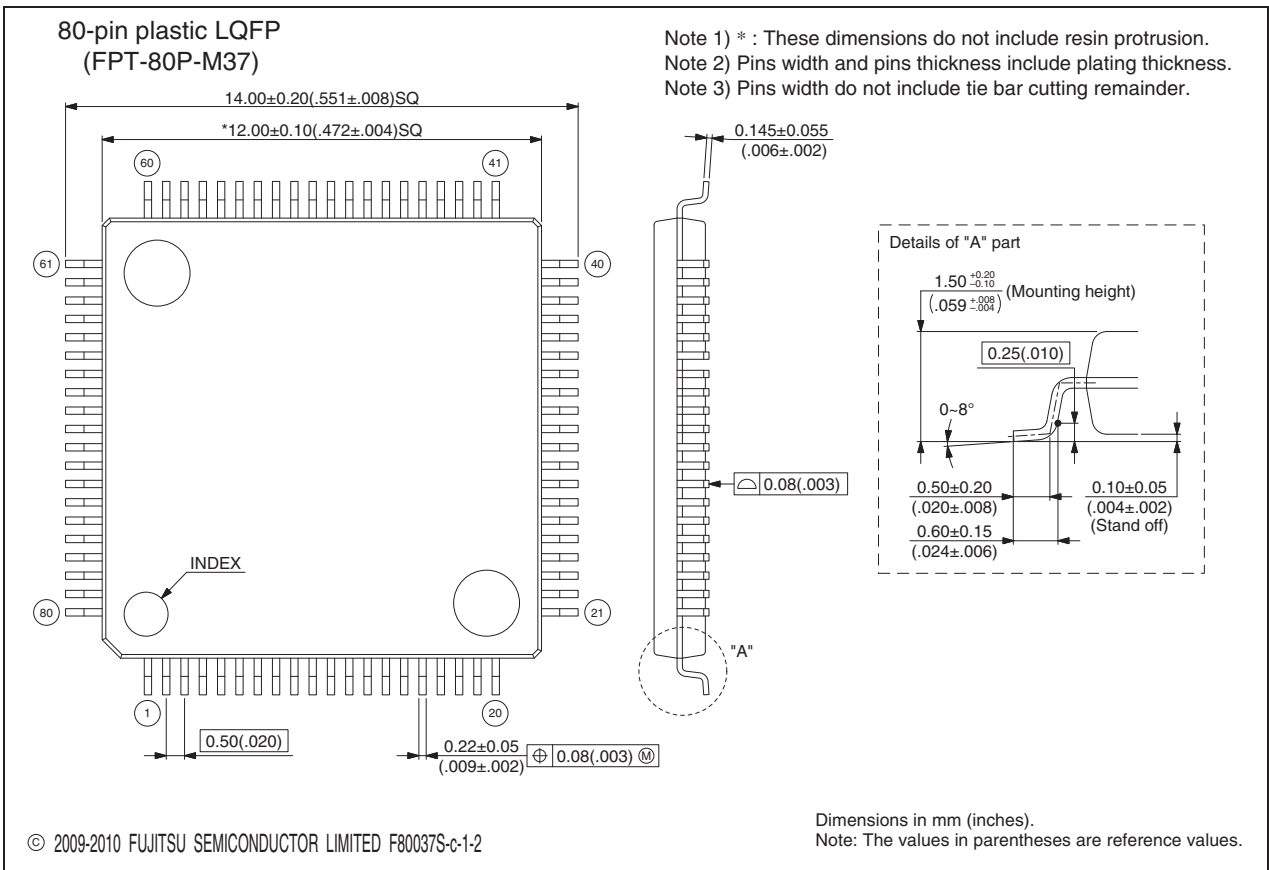

Please check the latest package dimension at the following URL.  
<http://edevic.fujitsu.com/package/en-search/>

(Continued)

# MB95310L/370L Series

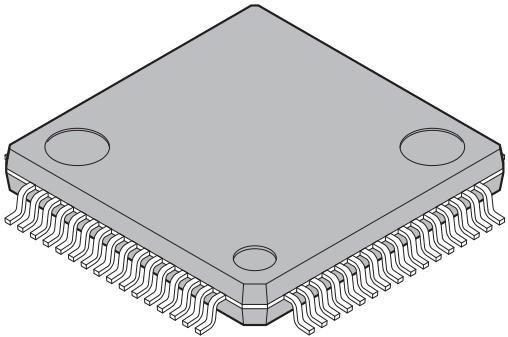
<p>64-pin plastic LQFP</p>  <p>(FPT-64P-M38)</p>	Lead pitch	0.50 mm
	Package width × package length	10.00 mm × 10.00 mm
	Lead shape	Gullwing
	Lead bend direction	Normal bend
	Sealing method	Plastic mold
	Mounting height	1.70 mm MAX
	Weight	0.32 g

64-pin plastic LQFP (FPT-64P-M38)

Note 1) \* : These dimensions do not include resin protrusion.  
 Note 2) Pins width and pins thickness include plating thickness.  
 Note 3) Pins width do not include tie bar cutting remainder.

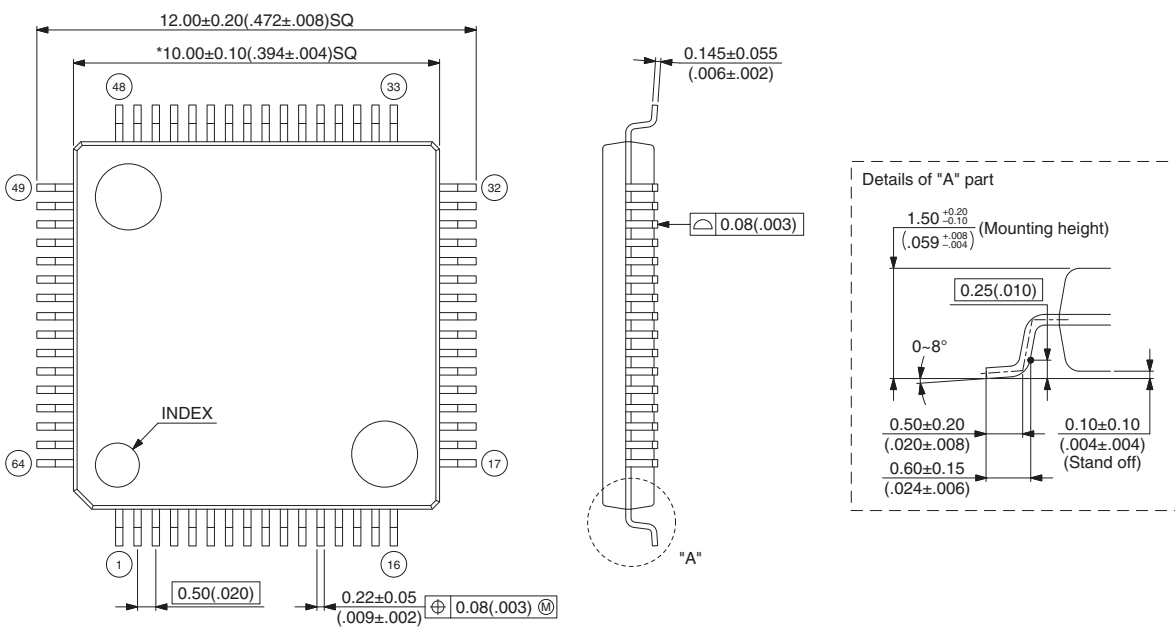

Top view dimensions:  
 Overall width:  $12.00 \pm 0.20$  (.472 ± .008) SQ  
 Pin pitch area:  $*10.00 \pm 0.10$  (.394 ± .004) SQ  
 Pin pitch: 0.50 (.020)  
 Pin thickness:  $0.22 \pm 0.05$  (.009 ± .002)  
 Pin width:  $0.08$  (.003) Ⓜ

Side view dimensions:  
 Lead thickness:  $0.145 \pm 0.055$  (.006 ± .002)  
 Lead width:  $0.08$  (.003)

Details of "A" part:  
 Mounting height:  $1.50^{+0.20}_{-0.10}$  (.059  $^{+0.008}_{-.004}$ )  
 Lead width: 0.25 (.010)  
 Lead angle: 0~8°  
 Stand off:  $0.10 \pm 0.10$  (.004 ± .004)  
 Pin width:  $0.50 \pm 0.20$  (.020 ± .008)  
 Pin thickness:  $0.60 \pm 0.15$  (.024 ± .006)

© 2010 FUJITSU SEMICONDUCTOR LIMITED F64038S-c-1-2

Dimensions in mm (inches).  
 Note: The values in parentheses are reference values.

Please check the latest package dimension at the following URL.  
<http://edevice.fujitsu.com/package/en-search/>

(Continued)

# MB95310L/370L Series

(Continued)

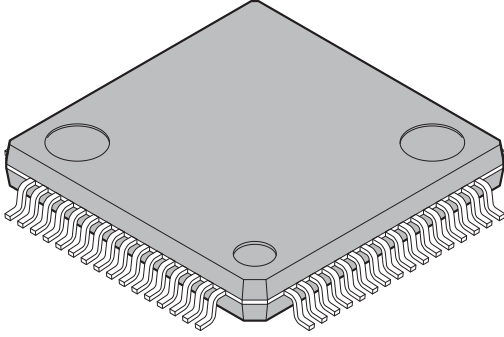
<p>64-pin plastic LQFP</p>  <p>(FPT-64P-M39)</p>	Lead pitch	0.65 mm
	Package width × package length	12.00 mm × 12.00 mm
	Lead shape	Gullwing
	Sealing method	Plastic mold
	Mounting height	1.70 mm MAX
	Weight	0.47 g

64-pin plastic LQFP (FPT-64P-M39)

Note 1) Pins width and pins thickness include plating thickness.

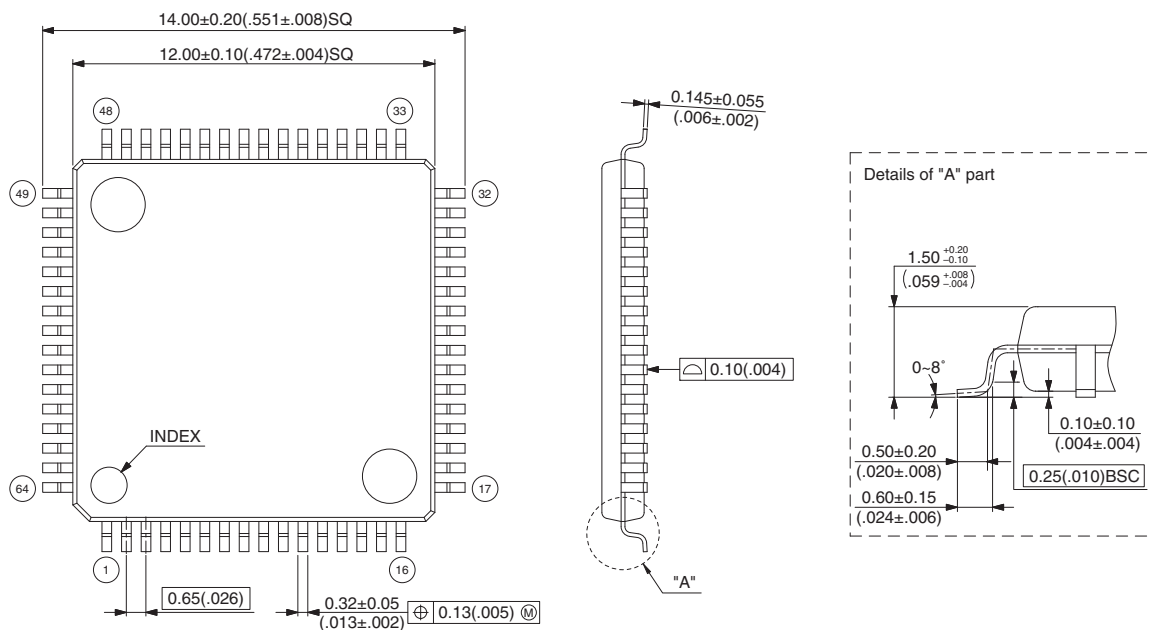

Top view dimensions:  
 Overall width:  $14.00 \pm 0.20$  ( $.551 \pm .008$ ) SQ  
 Pin pitch:  $0.65$  ( $.026$ )  
 Pin width:  $0.32 \pm 0.05$  ( $.013 \pm .002$ )  
 Pin thickness:  $0.13$  ( $.005$ )

Side view dimensions:  
 Pin width:  $0.145 \pm 0.055$  ( $.006 \pm .002$ )  
 Pin thickness:  $0.10$  ( $.004$ )

Details of "A" part:  
 Lead height:  $1.50^{+0.20}_{-0.10}$  ( $.059^{+.008}_{-.004}$ )  
 Lead angle: 0-8°  
 Lead thickness:  $0.10 \pm 0.10$  ( $.004 \pm .004$ )  
 Lead width:  $0.50 \pm 0.20$  ( $.020 \pm .008$ )  
 Lead thickness:  $0.60 \pm 0.15$  ( $.024 \pm .006$ )  
 Reference: 0.25(.010)BSC

© 2010-2011 FUJITSU SEMICONDUCTOR LIMITED HMbF64-39Sc-2-2

Dimensions in mm (inches).  
 Note: The values in parentheses are reference values.

Please check the latest package dimension at the following URL.  
<http://edevice.fujitsu.com/package/en-search/>



## ■ MAJOR CHANGES IN THIS EDITION

A change on a page is indicated by a vertical line drawn on the left side of that page.

Page	Section	Details
1	—	Changed the family name. F <sup>2</sup> MC-8FX → New 8FX
1	■ FEATURES	Changed the main CR clock oscillation frequency. 1/8/10 MHz ±3%, maximum machine clock frequency: 10 MHz → 1/8/10/12.5 MHz ±2%, maximum machine clock frequency: 12.5 MHz
23	■ PIN CONNECTION	Added “• Notes on handling the external clock pins while using the CR clock”.
46	■ ELECTRICAL CHARACTERISTICS 3. DC Characteristics	Changed the condition for the power supply current (I <sub>CCMCR</sub> ). F <sub>CRH</sub> = 10 MHz F <sub>MP</sub> = 10 MHz Main CR clock mode → F <sub>CRH</sub> = 12.5 MHz F <sub>MP</sub> = 12.5 MHz Main CR clock mode  Changed the condition for the power supply current (I <sub>CCSCR</sub> ). F <sub>CL</sub> = 32 kHz F <sub>MPL</sub> = 16 kHz Sub-CR clock mode (divided by 2) T <sub>A</sub> = +25°C → Sub-CR clock mode (divided by 2) T <sub>A</sub> = +25°C
47		Changed the condition for the power supply current (I <sub>CRH</sub> ). Current consumption for the main CR oscillator at 10 MHz → Current consumption for the main CR oscillator
48	■ ELECTRICAL CHARACTERISTICS 4. AC Characteristics (1) Clock Timing	Changed the values of the clock frequency (F <sub>CRH</sub> ).
58	■ ELECTRICAL CHARACTERISTICS 4. AC Characteristics (7) Low-voltage Detection	Deleted the following parameters: Power hysteresis width 0, Power hysteresis width 1, Power hysteresis width 2, Interrupt hysteresis width 0, Interrupt hysteresis width 1, Interrupt hysteresis width 2, Interrupt hysteresis width 3, Interrupt hysteresis width 4
59		Deleted V <sub>PHYS</sub> /V <sub>IHYS</sub> from the diagram.
64	■ ELECTRICAL CHARACTERISTICS 4. AC Characteristics (8) I <sup>2</sup> C Timing	Changed the settings related to the machine clock shown in *2.
70 to 75	■ SAMPLE CHARACTERISTICS	Added “■ SAMPLE CHARACTERISTICS”.

**MEMO**

**MEMO**

# MB95310L/370L Series

## FUJITSU SEMICONDUCTOR LIMITED

Nomura Fudosan Shin-yokohama Bldg. 10-23, Shin-yokohama 2-Chome,  
Kohoku-ku Yokohama Kanagawa 222-0033, Japan  
Tel: +81-45-415-5858  
<http://jp.fujitsu.com/fsl/en/>

For further information please contact:

### North and South America

FUJITSU SEMICONDUCTOR AMERICA, INC.  
1250 E. Arques Avenue, M/S 333  
Sunnyvale, CA 94085-5401, U.S.A.  
Tel: +1-408-737-5600 Fax: +1-408-737-5999  
<http://us.fujitsu.com/micro/>

### Europe

FUJITSU SEMICONDUCTOR EUROPE GmbH  
Pittlerstrasse 47, 63225 Langen, Germany  
Tel: +49-6103-690-0 Fax: +49-6103-690-122  
<http://emea.fujitsu.com/semiconductor/>

### Korea

FUJITSU SEMICONDUCTOR KOREA LTD.  
902 Kosmo Tower Building, 1002 Daechi-Dong,  
Gangnam-Gu, Seoul 135-280, Republic of Korea  
Tel: +82-2-3484-7100 Fax: +82-2-3484-7111  
<http://kr.fujitsu.com/fsk/>

### Asia Pacific

FUJITSU SEMICONDUCTOR ASIA PTE. LTD.  
151 Lorong Chuan,  
#05-08 New Tech Park 556741 Singapore  
Tel : +65-6281-0770 Fax : +65-6281-0220  
<http://www.fujitsu.com/sg/services/micro/semiconductor/>

### FUJITSU SEMICONDUCTOR SHANGHAI CO., LTD.

Rm. 3102, Bund Center, No.222 Yan An Road (E),  
Shanghai 200002, China  
Tel : +86-21-6146-3688 Fax : +86-21-6335-1605  
<http://cn.fujitsu.com/fss/>

### FUJITSU SEMICONDUCTOR PACIFIC ASIA LTD.

10/F., World Commerce Centre, 11 Canton Road,  
Tsimshatsui, Kowloon, Hong Kong  
Tel : +852-2377-0226 Fax : +852-2376-3269  
<http://cn.fujitsu.com/fsp/>

Specifications are subject to change without notice. For further information please contact each office.

### All Rights Reserved.

The contents of this document are subject to change without notice.

Customers are advised to consult with sales representatives before ordering.

The information, such as descriptions of function and application circuit examples, in this document are presented solely for the purpose of reference to show examples of operations and uses of FUJITSU SEMICONDUCTOR device; FUJITSU SEMICONDUCTOR does not warrant proper operation of the device with respect to use based on such information. When you develop equipment incorporating the device based on such information, you must assume any responsibility arising out of such use of the information.

FUJITSU SEMICONDUCTOR assumes no liability for any damages whatsoever arising out of the use of the information.

Any information in this document, including descriptions of function and schematic diagrams, shall not be construed as license of the use or exercise of any intellectual property right, such as patent right or copyright, or any other right of FUJITSU SEMICONDUCTOR or any third party or does FUJITSU SEMICONDUCTOR warrant non-infringement of any third-party's intellectual property right or other right by using such information. FUJITSU SEMICONDUCTOR assumes no liability for any infringement of the intellectual property rights or other rights of third parties which would result from the use of information contained herein.

The products described in this document are designed, developed and manufactured as contemplated for general use, including without limitation, ordinary industrial use, general office use, personal use, and household use, but are not designed, developed and manufactured as contemplated (1) for use accompanying fatal risks or dangers that, unless extremely high safety is secured, could have a serious effect to the public, and could lead directly to death, personal injury, severe physical damage or other loss (i.e., nuclear reaction control in nuclear facility, aircraft flight control, air traffic control, mass transport control, medical life support system, missile launch control in weapon system), or (2) for use requiring extremely high reliability (i.e., submersible repeater and artificial satellite).

Please note that FUJITSU SEMICONDUCTOR will not be liable against you and/or any third party for any claims or damages arising in connection with above-mentioned uses of the products.

Any semiconductor devices have an inherent chance of failure. You must protect against injury, damage or loss from such failures by incorporating safety design measures into your facility and equipment such as redundancy, fire protection, and prevention of over-current levels and other abnormal operating conditions.

Exportation/release of any products described in this document may require necessary procedures in accordance with the regulations of the Foreign Exchange and Foreign Trade Control Law of Japan and/or US export control laws.

The company names and brand names herein are the trademarks or registered trademarks of their respective owners.

Edited: Sales Promotion Department