

## AFL-Series Sensors—Low Power, Low Voltage Digital Switches

### Features:

- Low voltage operation to 0.9 V
- Low current consumption
- Digital switch output
- Precise detection of low magnetic fields
- Ultra-small packages (MSOP8 and TDFN6)
- Available in millimeter-scale die
- Cannot be damaged by large magnetic fields

### Description:

NVE's AFL-Series Sensors are digital switches designed to run at very low voltages and currents. The parts can operate from a single battery. The output is configured as a switch to detect magnetic fields, switching on at a specified magnetic field, and off when the field is removed. Current-sinking or current-sourcing output configurations are available. Both configurations supply up to 100  $\mu$ A. An external pull-up or pull-down resistor is required. The devices are available in MSOP8 or TDFN6 packages, or in die form.

### AFL Product Selection Guide

AFL-Series part numbers follow the general form below. The first "x" in the part number specifies the voltage range, the second "x" denotes the output configuration, the third "x" specifies the magnetic operate point, and the last character pair specifies the package. The following sections define these options.

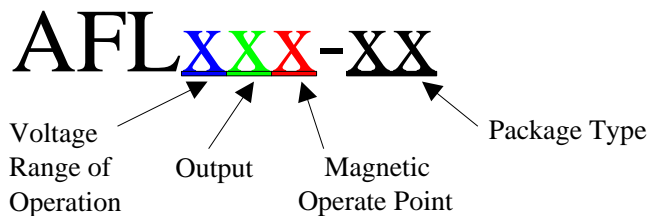

## Voltage Range of Operation

The first numeric digit of the part number in the form AFLxxx-xx specifies the operating voltage range. Four ranges are available:

### NVE AFL xxx-xx

Number	Voltage Range of Operation
0	0.9 V – 1.3 V
1	1.8 V – 2.5 V
2	2.7 V – 3.6 V
3	4.5 V – 5.5 V

The quiescent supply current specifications apply within these ranges. Parts may be operated at higher voltage than shown up to a maximum of 7 V, but the quiescent current will increase. For example, a “1xx-xx” part can be operated up to 3.0 V although it might exceed the quiescent current specification.

NVE can supply custom parts for different voltage ranges. Minimum order quantities, special pricing, NRE charges, and lead times may apply. Please contact NVE with your requirements.

## Output

The second digit of the part number specifies the output configuration. Four output types are available:

### NVE AFL xxx-xx

Number	Output Type
0	Normally Off, Current Sink
1	Normally On, Current Sink
2	Normally On, Current Source
3	Normally Off, Current Source

“Normally Off” means that with no magnetic field applied the output will not provide current; when the magnetic field is applied, the output current will turn on. “Normally On” is opposite. Parts will sink or source up to 100  $\mu$ A. Output current is not included in the quiescent current specification.

## Magnetic Operate Point and Direction of Sensitivity

Standard magnetic operate points are shown in the table below. Non-standard magnetic operate points are available, but special pricing, minimum order quantities, NRE charges, and lead times may apply.

### NVE AFL xxx-xx

Number	Magnetic Operate Point
0	10 Oe
1	20 Oe
2	28 Oe
3	40 Oe
4	80 Oe
5	7 Oe

All AFL-Series parts feature cross-axis sensitivity as shown in the following diagrams:

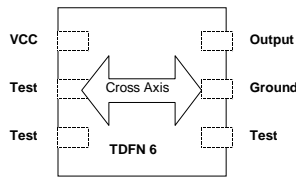
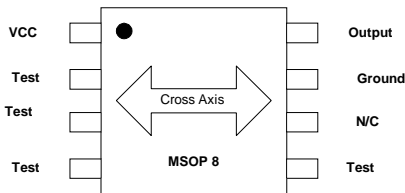

## Package Types

AFL-Series parts are available in two different packages: an 8-pin Micro Small Outline Package (MSOP) and a 6-pin ultra-miniature leadless TDFN package. Parts are also available in die form. Package type part numbers are shown in the table below; drawings are at the end of this specification.

### NVE AFL xxx-xx

Number	Package Type
00	MSOP8
01	IC Only
10	TDFN6

## Available Parts

The following parts in this series are currently available:

AFL000-00E	AFL000-10E	AFL000-01
AFL001-10E	AFL002-10E	AFL005-10E
AFL020-00E	AFL030-00E	AFL100-00E
AFL100-10E	AFL103-01	AFL200-00E
AFL300-00E		

### Notes:

1. Part types are continuously added. Contact factory for current part availability.
2. The "E" suffix indicates a lead-free, RoHS-compliant package.
3. All die versions (-01 suffix) are lead-free and RoHS compliant.

## Electrical and Magnetic Specifications

Parameter	Min.	Typ.	Max.	Units
Magnetic Operate Point (AFLxx0-xx)	7	10	13	Oersteds
Operate/Release Differential (AFLxx0-xx)	1		6	Oersteds
Magnetic Operate Point (AFLxx1-xx)	15	20	25	Oersteds
Operate/Release Differential (AFLxx1-xx)	3		10	Oersteds
Magnetic Operate Point (AFLxx2-xx)	21	28	34	Oersteds
Operate/Release Differential (AFLxx2-xx)	3		10	Oersteds
Magnetic Operate Point (AFLxx5-xx)	4	7	10	Oersteds
Operate/Release Differential (AFLxx5-xx)	1		6	Oersteds
Operating Voltage (AFL0xx-xx)	0.9	1.1	1.3	Volts
Operating Voltage (AFL1xx-xx)	1.8	2.2	2.5	Volts
Operating Voltage (AFL2xx-xx)	2.7	3.2	3.6	Volts
Operating Voltage (AFL3xx-xx)	4.5	5.0	5.5	Volts
Quiescent Current (AFL000-xx)	20	35	55	μA
Quiescent Current (AFL020-xx)	30	50	75	μA
Quiescent Current (AFL030-xx)	15	35	55	μA
Quiescent Current (AFL100-xx)	25	35	45	μA
Quiescent Current (AFL200-xx)	30	35	45	μA
Quiescent Current (AFL300-xx)	30	40	50	μA
Maximum Output Drive Current (Sink or Source)	100			μA
V <sub>OL</sub> at 100 μA Output Drive Current			0.200	Volts
V <sub>OH</sub> at 100 μA Output Drive Current	V <sub>CC</sub> - 0.150			Volts
Frequency Response	100			KHz
Temperature Range of Operation	-20		85	°C

### Notes:

1. Large magnetic fields WILL NOT damage NVE GMR Sensors
2. One Oersted (Oe) = 1 Gauss in air = 0.1 mT

## Operation

The magnetic field must be applied planar to the package in the direction of sensitivity. When the magnetic field reaches the magnetic operate point, the output will turn on. There should be a pull-up or pull-down resistor on the output terminal.

## Functional Diagrams and Pinout

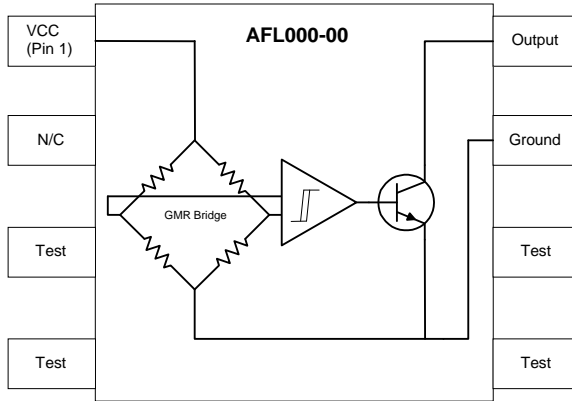

Direction of Sensitivity

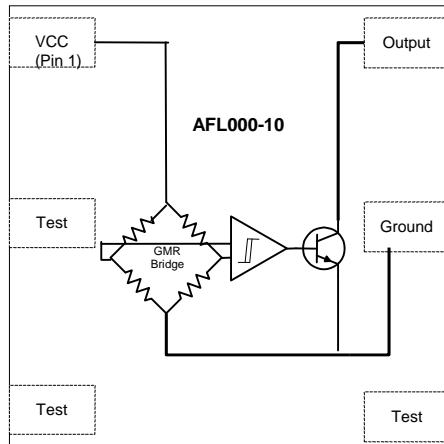

## IC Drawing and Layout

The IC is approximately 1.45 mm x 1.5 mm. A die drawing is shown below:

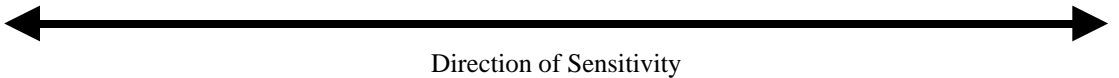
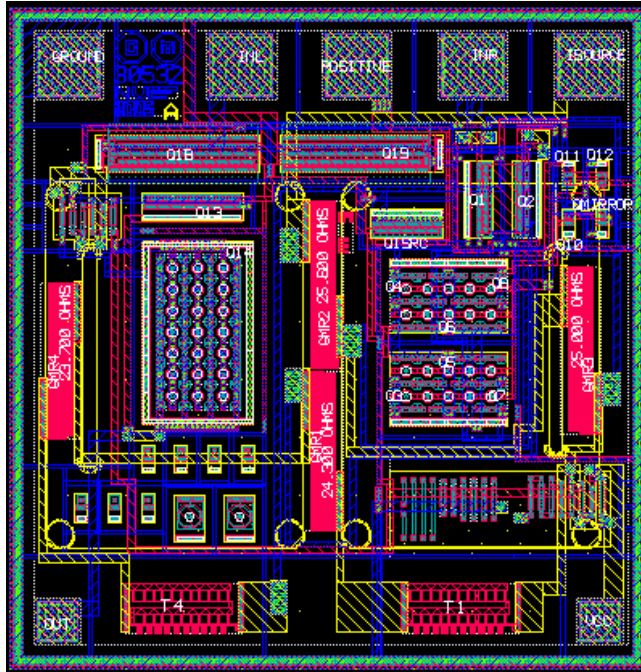

Direction of Sensitivity

## Package Drawings and Specifications

### MSOP8

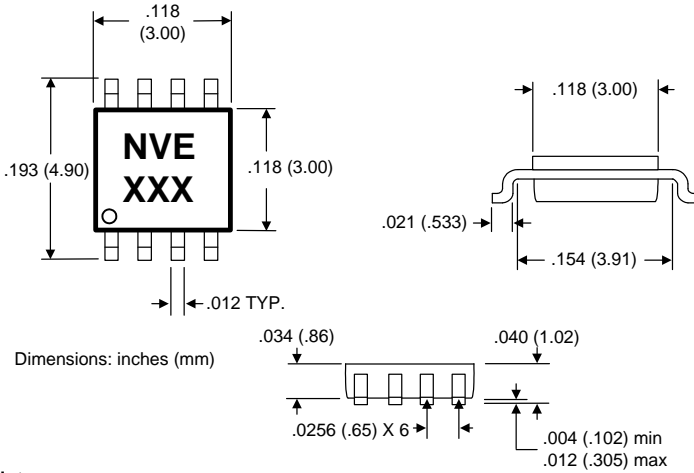

**Notes:**

1. The MSOP8 package has thermal power dissipation of 320°C/Watt in free air.
2. Thermal performance is improved when the package is soldered to a circuit board.

### 2.5 mm x 2.5 mm TDFN6

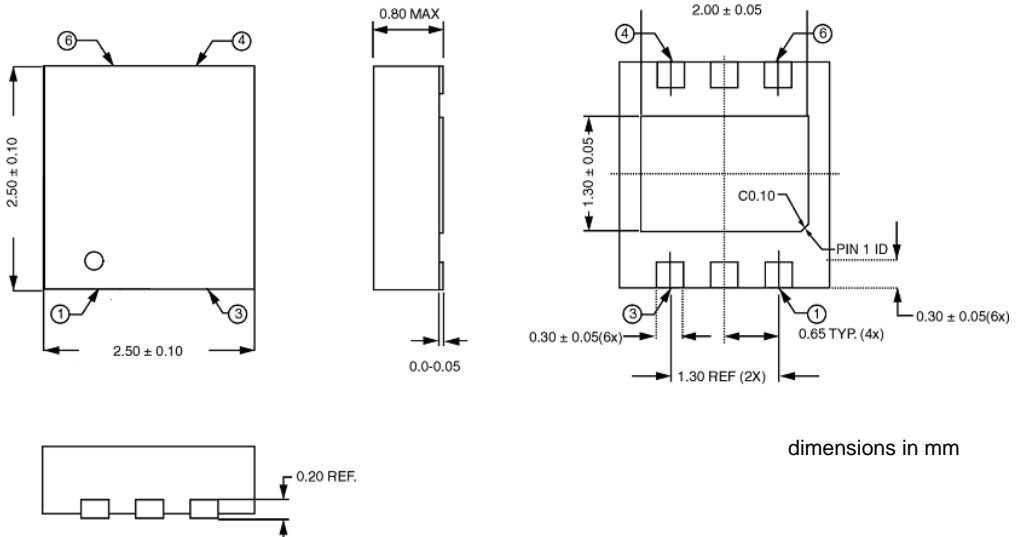

**Notes:**

1. The TDFN6 package has thermal power dissipation of 320°C/Watt in free air.
2. Thermal performance is improved when the package is soldered to a circuit board.

The complete part number will not fit on TDFN6 or MSOP8 packages, so a three-digit code is used. The package codes are listed below:

<b>Part Number</b>	<b>Marking Code</b>
AFL000-00E	PBBe
AFL000-10E	QBBe
AFL001-10E	QBXe
AFL002-10E	QBLLe
AFL005-10E	QBKe
AFL020-00E	PBCe
AFL030-00E	PBDe
AFL100-00E	PBFfe
AFL100-10E	QBFe
AFL200-00E	PBGe
AFL300-00E	PBHe



## Datasheet Limitations

The information and data provided in datasheets shall define the specification of the product as agreed between NVE and its customer, unless NVE and customer have explicitly agreed otherwise in writing. All specifications are based on NVE test protocols. In no event however, shall an agreement be valid in which the NVE product is deemed to offer functions and qualities beyond those described in the datasheet.

## Limited Warranty and Liability

Information in this document is believed to be accurate and reliable. However, NVE does not give any representations or warranties, expressed or implied, as to the accuracy or completeness of such information and shall have no liability for the consequences of use of such information.

In no event shall NVE be liable for any indirect, incidental, punitive, special or consequential damages (including, without limitation, lost profits, lost savings, business interruption, costs related to the removal or replacement of any products or rework charges) whether or not such damages are based on tort (including negligence), warranty, breach of contract or any other legal theory.

## Right to Make Changes

NVE reserves the right to make changes to information published in this document including, without limitation, specifications and product descriptions at any time and without notice. This document supersedes and replaces all information supplied prior to its publication.

## Use in Life-Critical or Safety-Critical Applications

Unless NVE and a customer explicitly agree otherwise in writing, NVE products are not designed, authorized or warranted to be suitable for use in life support, life-critical or safety-critical devices or equipment. NVE accepts no liability for inclusion or use of NVE products in such applications and such inclusion or use is at the customer's own risk. Should the customer use NVE products for such application whether authorized by NVE or not, the customer shall indemnify and hold NVE harmless against all claims and damages.

## Applications

Applications described in this datasheet are illustrative only. NVE makes no representation or warranty that such applications will be suitable for the specified use without further testing or modification.

Customers are responsible for the design and operation of their applications and products using NVE products, and NVE accepts no liability for any assistance with applications or customer product design. It is customer's sole responsibility to determine whether the NVE product is suitable and fit for the customer's applications and products planned, as well as for the planned application and use of customer's third party customers. Customers should provide appropriate design and operating safeguards to minimize the risks associated with their applications and products.

NVE does not accept any liability related to any default, damage, costs or problem which is based on any weakness or default in the customer's applications or products, or the application or use by customer's third party customers. The customer is responsible for all necessary testing for the customer's applications and products using NVE products in order to avoid a default of the applications and the products or of the application or use by customer's third party customers. NVE accepts no liability in this respect.

## Limiting Values

Stress above one or more limiting values (as defined in the Absolute Maximum Ratings System of IEC 60134) will cause permanent damage to the device. Limiting values are stress ratings only and operation of the device at these or any other conditions above those given in the recommended operating conditions of the datasheet is not warranted. Constant or repeated exposure to limiting values will permanently and irreversibly affect the quality and reliability of the device.

## Terms and Conditions of Sale

In case an individual agreement is concluded only the terms and conditions of the respective agreement shall apply. NVE hereby expressly objects to applying the customer's general terms and conditions with regard to the purchase of NVE products by customer.

## No Offer to Sell or License

Nothing in this document may be interpreted or construed as an offer to sell products that is open for acceptance or the grant, conveyance or implication of any license under any copyrights, patents or other industrial or intellectual property rights.

## Export Control

This document as well as the items described herein may be subject to export control regulations. Export might require a prior authorization from national authorities.

## Automotive Qualified Products

Unless the datasheet expressly states that a specific NVE product is automotive qualified, the product is not suitable for automotive use. It is neither qualified nor tested in accordance with automotive testing or application requirements. NVE accepts no liability for inclusion or use of non-automotive qualified products in automotive equipment or applications.

In the event that customer uses the product for design-in and use in automotive applications to automotive specifications and standards, customer (a) shall use the product without NVE's warranty of the product for such automotive applications, use and specifications, and (b) whenever customer uses the product for automotive applications beyond NVE's specifications such use shall be solely at customer's own risk, and (c) customer fully indemnifies NVE for any liability, damages or failed product claims resulting from customer design and use of the product for automotive applications beyond NVE's standard warranty and NVE's product specifications.