

Peak Sensitivity Wavelength: 562nm

The 562nm visible emitter series is designed for applications requiring high output and precise optical / mechanical axis alignment. Custom package solutions and sorting are available.

FEATURES

- > TO-18 Metal Can Package
- > High Output Power
- > High Reliability

APPLICATIONS

- > Color Sensor / Money Bill
- > Paper Sensor / Money Bill
- > Bar-code Reader
- > Fiber Applications



Absolute Maximum Ratings (Ta=25°C)



ITEMS	SYMBOL	RATINGS	UNIT
Forward Current (DC)	IF	50	mA
Forward Current (Pulse)*1	IFP	0.5	A
Reverse Voltage	VR	5	V
Power Dissipation	PD	140	mW
Operating Temperature Range	Topr	-20 ~ +85	°C
Storage Temperature Range	Tstg	-30 ~ +100	°C
Junction Temperature	Tj	100	°C
Lead Soldering Temperature*2	Tls	260	°C

*1: Tw=10μsec, T=10msec. *2: Time 5 Sec max, Position: Up to 3mm from the body.

Electrical & Optical Characteristics (Ta = 25°C)

ITEMS	SYMBOL	CONDITIONS	MIN	TYP	MAX	UNIT
Power Output	PO	IF=20mA	0.1	0.15	--	mW
Forward Voltage	VF	IF=20mA	--	2.3	2.7	V
Reverse Current	IR	VR=5V	--	--	100	μA
Peak Emission Wavelength	λp	IF=20mA	--	562	--	nm
Spectral Line Half Width	Δλ	IF=20mA	--	11	--	nm
Half Intensity Beam Angle	Θ	IF=20mA	--	±20	--	deg
Rise Time	Tr	IFP=20mA	--	--	--	μS
Fall Time	Tf	IFP=20mA	--	--	--	μS
Junction Capacitance	Cj	1MHz, V=0V	--	10	--	pF
Temperature Coefficient of PO	P/T	IF=10mA	--	-0.7	--	%/°C
Temperature Coefficient of VF	V/T	IF=10mA	--	-2.6	--	mV/°C

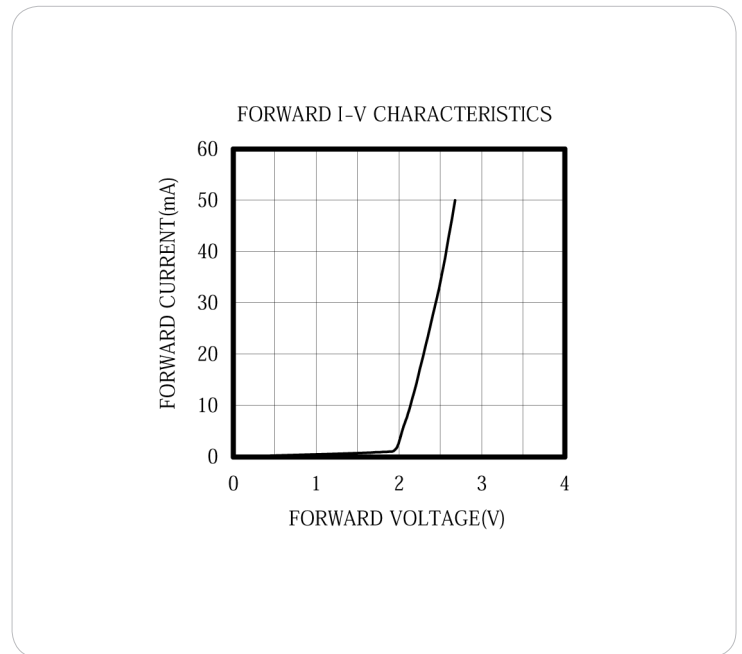
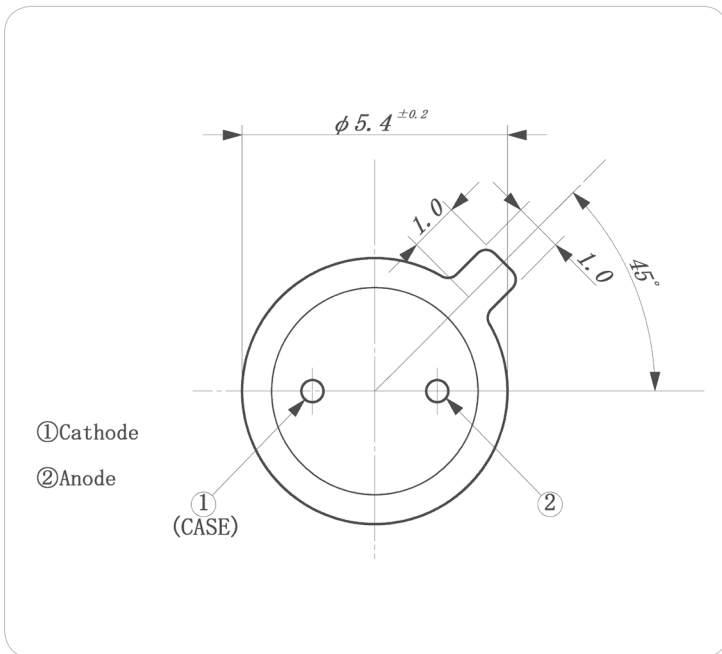
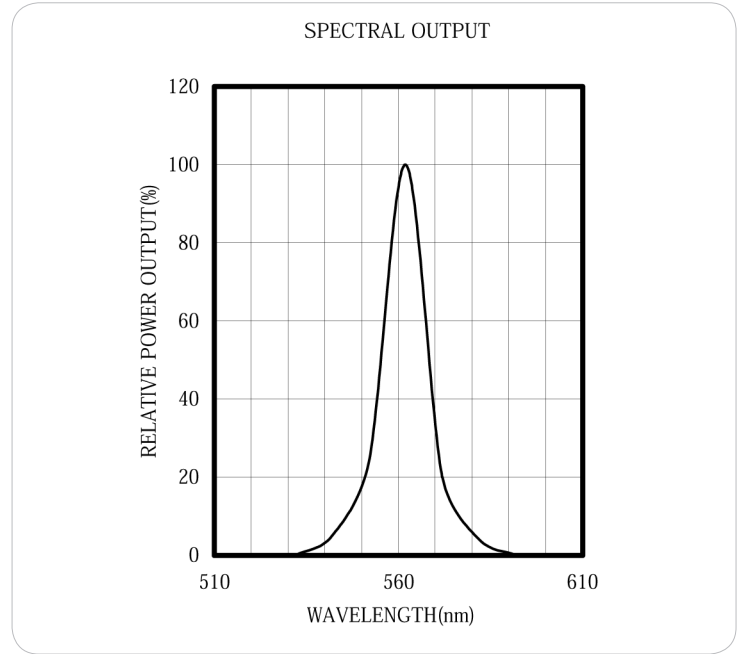
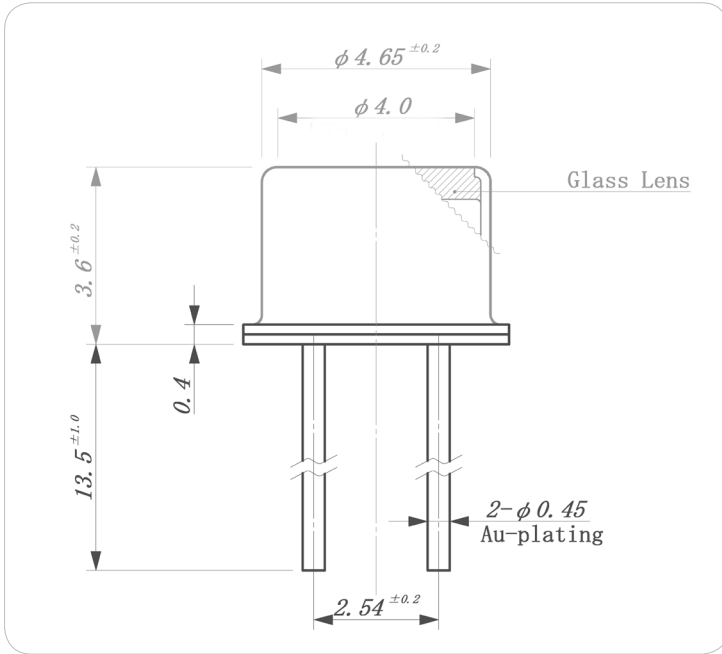

Unit: mm, Tolerance: ± 0.2

