

Peak Emission Wavelength: 850nm

The 850nm high power infrared LED Series is designed for application requiring high accuracy and precision as well as uniform spectral emission. Custom package solutions and sorting are available.

FEATURES

- > Hermetically Sealed TO-18
- > High Output Power
- > Gold Plated Dome Lens
- > Narrow Beam Angle / High Reliability

APPLICATIONS

- > Optical Scanning
- > Linear & Rotary Encoder
- > Edge Sensing / Optical Sensors
- > Optical Switches / Security Systems

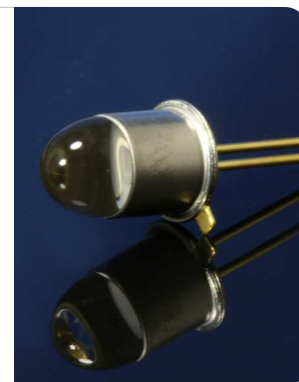

Absolute Maximum Ratings (Ta=25°C)



ITEMS	SYMBOL	RATINGS	UNIT
Forward Current (DC)	IF	100	mA
Forward Current (Pulse)*1	IFP	1	A
Reverse Voltage	VR	5	V
Power Dissipation	PD	200	mW
Operating Temperature Range	Topr	-20 ~ +85	°C
Storage Temperature Range	Tstg	-30 ~ +100	°C
Junction Temperature	Tj	260	°C

*1: Tw=10μsec, T=10msec.

Electrical & Optical Characteristics (Ta = 25°C)

ITEMS	SYMBOL	CONDITIONS	MIN	TYP	MAX	UNIT
Power Output	PO	IF=50mA	--	6.0	--	mW
Forward Voltage	VF	IF=50mA	--	1.5	2.0	V
Reverse Current	IR	VR=5V	--	--	10	μA
Peak Emission Wavelength	λp	IF=50mA	--	850	--	nm
Spectral Line Half Width	Δλ	IF=50mA	--	45	--	nm
Half Intensity Beam Angle	Θ	IF=50mA	--	±3	--	deg

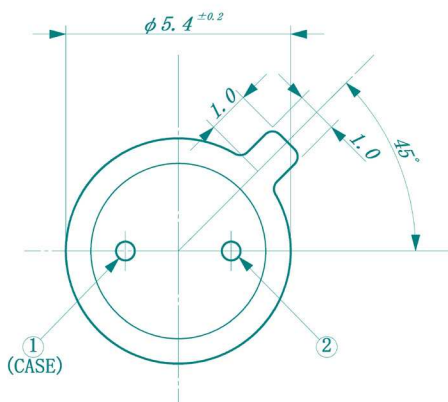
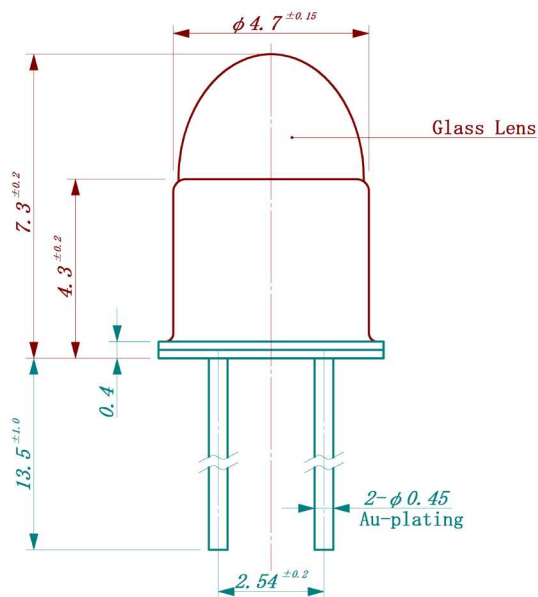

Unit: mm, Tolerance: ±0.2

The information contained herein is subject to change without notice.

2011-09-28