

Peak Emission Wavelength: 855nm

The 850nm Point Source Series is designed for applications requiring high accuracy and precision as well as uniform spectral emission. Custom package solutions and sorting are available.

FEATURES

- > PLCC-4 Package
- > Emitting Window Diameter Φ 150 μ m
- > High Reliability / High Output Power

APPLICATIONS

- > Optical Scanning
- > Linear & Rotary Encoder
- > Edge Sensing
- > Optical Sensors



Absolute Maximum Ratings (Ta=25°C)



ITEMS	SYMBOL	RATINGS	UNIT
Forward Current	IF	60	mA
Forward Current (Pulse)*1	IFP	400	mA
Reverse Voltage	VR	5	V
Power Dissipation	PD	110	mW
Operating Temperature Range	Topr	-20 ~ +85	°C
Storage Temperature Range	Tstg	-30 ~ +100	°C

*1: Tw≤100μsec [4% duty].

Electrical & Optical Characteristics (Ta = 25°C)

ITEMS	SYMBOL	CONDITIONS	MIN	TYP	MAX	UNIT
Power Output	PO	IF=20mA	2.0	3.0	--	mW
Power Output*1	PO	IFP=400mA	25	--	--	mW
Forward Voltage	VF	IF=20mA	--	1.65	2	V
Reverse Current	IR	VR=5V	--	--	100	μA
Peak Emission Wavelength	λ_p	IF=20mA	--	855	--	nm
Spectral Line Half Width	$\Delta\lambda$	IF=20mA	--	25	--	nm
Half Intensity Beam Angle	Θ	IF=20mA	--	±50	--	deg

*1: Tw=100μsec [4% duty].

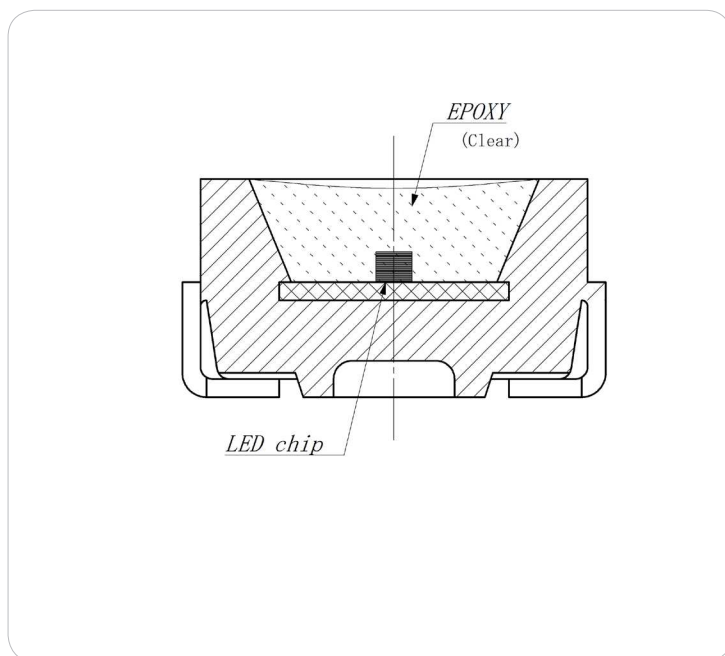
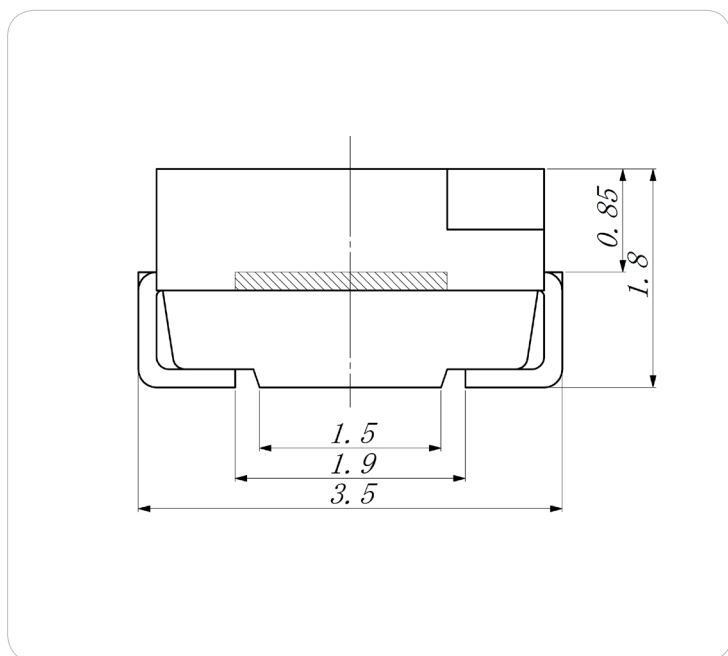
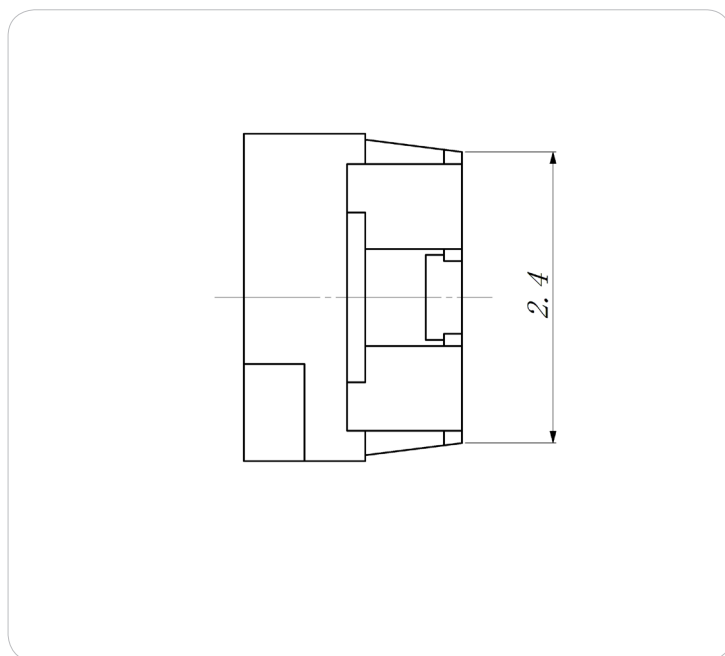
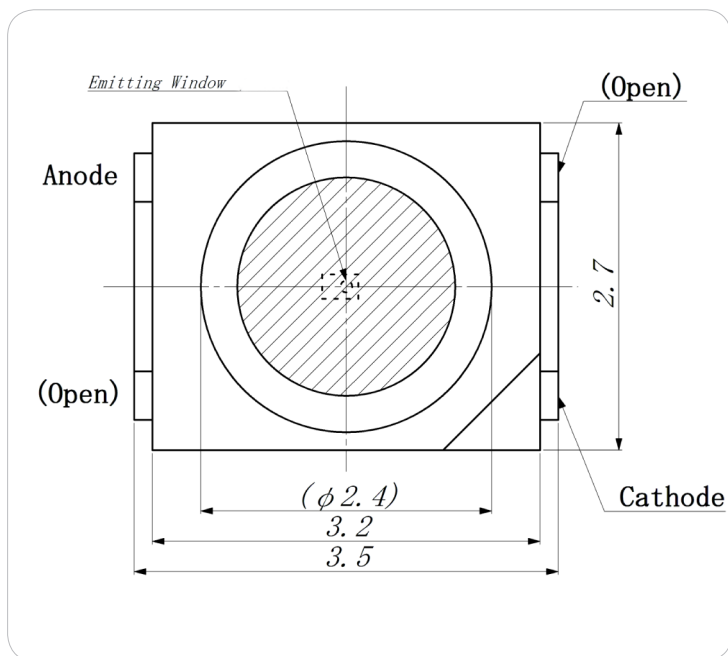

Unit: mm, Tolerance: ± 0.2

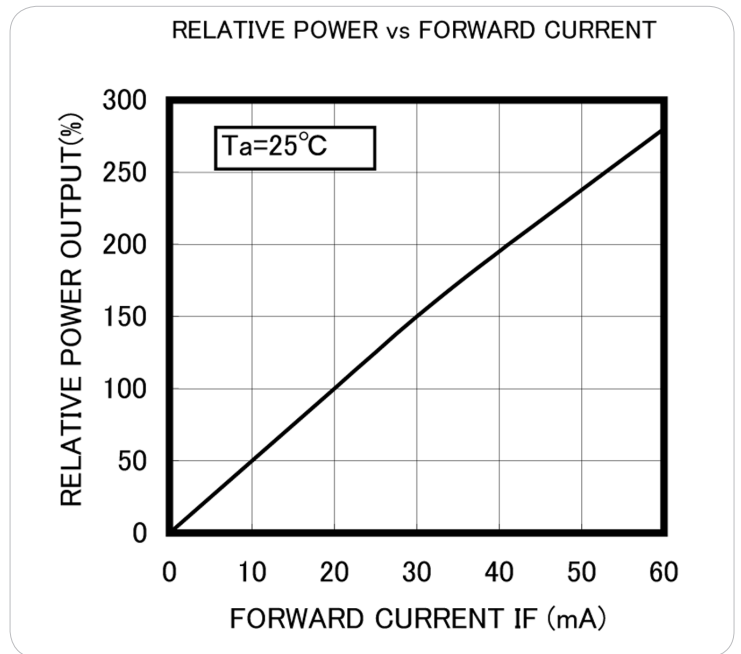
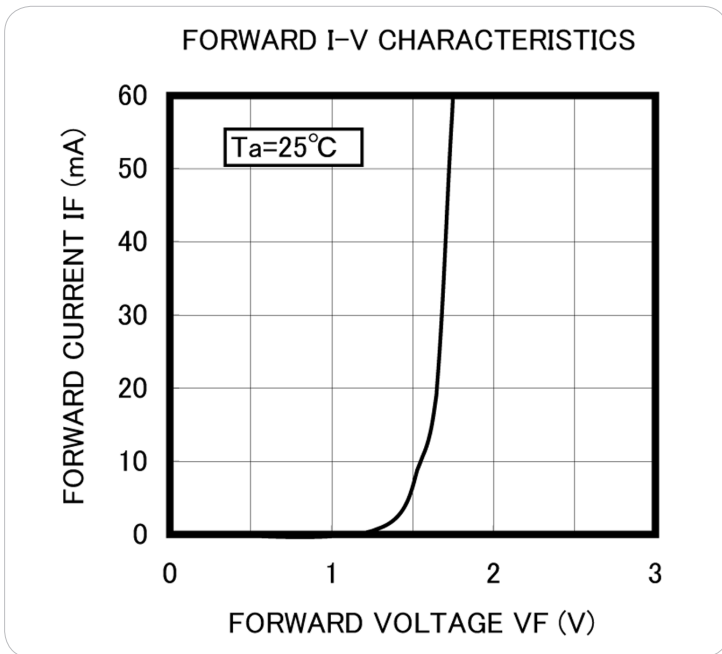
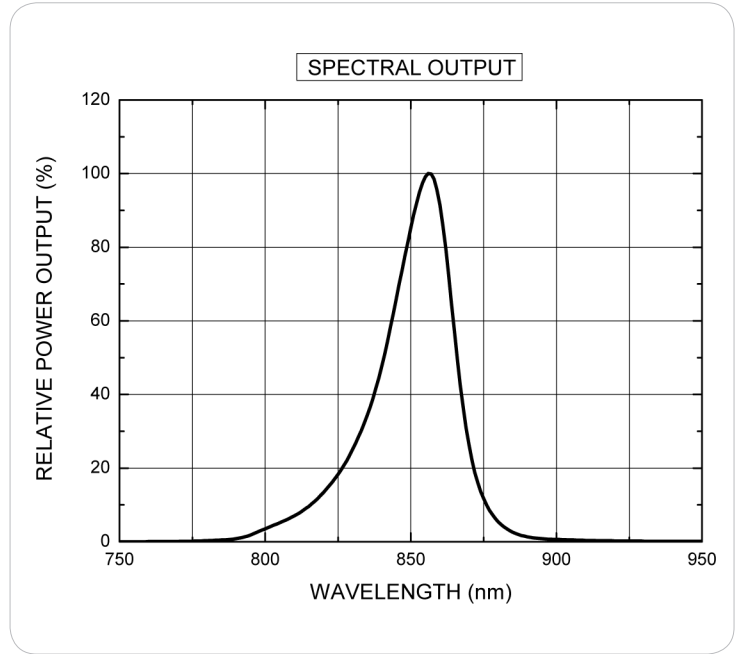
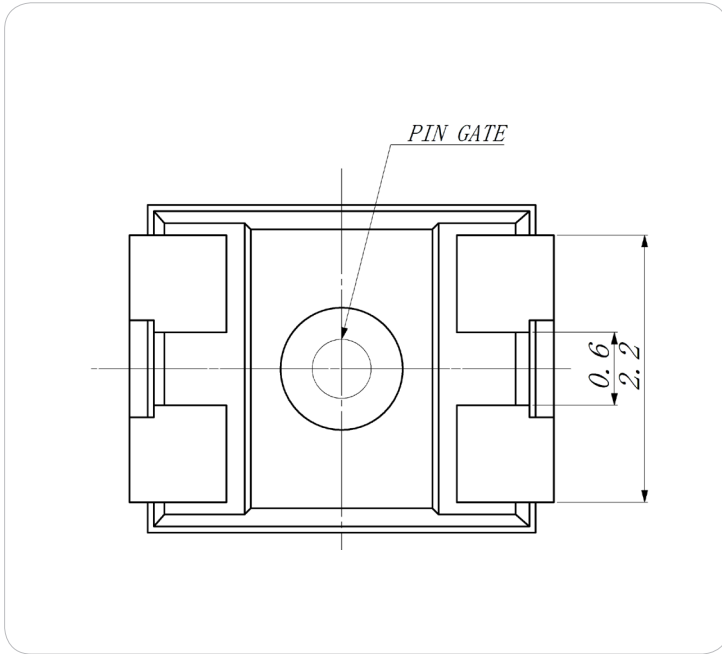

Unit: mm, Tolerance: ± 0.2

RADIATION PATTERN
IF=20mA

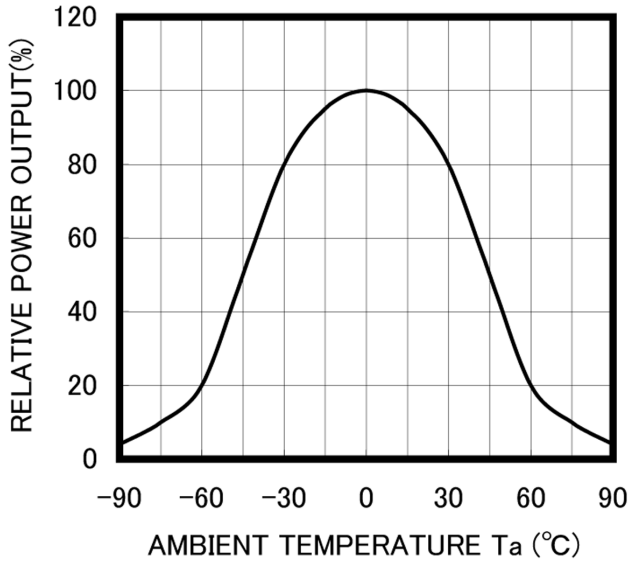

THERMAL DERATING CURVE

