

Peak Sensitivity Wavelength: 880nm

The MTD8000M3B-T is a photo transistor in a ceramic package. It is well suited for high reliability and high sensitivity applications.

FEATURES

- > High Reliability in Demanding Environments
- > Ceramic Package
- > Compact

APPLICATIONS

- > Optical Switches
- > Optical Sensors
- > Optical Detectors

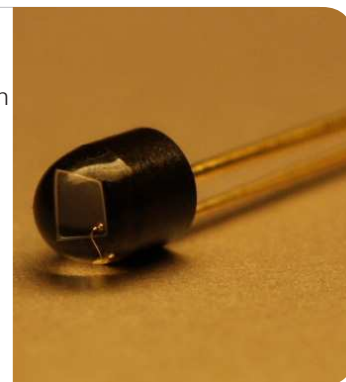

Absolute Maximum Ratings (Ta=25°C)



ITEMS	SYMBOL	RATINGS	UNIT
Collector-Emitter Voltage	Vceo	20	V
Emitter-Collector Voltage	Veco	5	V
Collector Current	Ic	30	mA
Collector Power Dissipation	Pc	80	mW
Operating Temperature Range	Topr	-25 ~ +85	°C
Storage Temperature Range	Tstg	-30 ~ +100	°C
Junction Temperature	Tj	100	°C
Lead Soldering Temperature*1	Tls	260	°C

*1: Time 5 Sec max, Position: Up to 3mm from the body.

Electrical & Optical Characteristics (Ta = 25°C)

ITEMS	SYMBOL	CONDITIONS	MIN	TYP	MAX	UNIT
Collector Emitter Current	Icel	Vce=10V, Ee=0.5mW/cm ² *1	--	1.0	--	mA
Collector Dark Current	Iceo	Vce=10V, Ee=0mW/cm ² *1	--	--	100	nA
C-E Saturation Voltage	VCE(sat)	Ic=0.2mA, Ee=5mW/cm ² *1	--	0.2	--	V
Spectral Sensitivity	λ	--	--	400~1100	--	nm
Peak Sensitivity Wavelength	λp	--	--	880	--	nm
Switching Time (Rise Time)	Tr	RL=100Ω, Vcc=5V, Ic=0.5mA	--	10.0	--	μS
Switching Time (Fall Time)	Tf	RL=100Ω, Vcc=5V, Ic=0.5mA	--	10.0	--	μS
Angular Response	θ	--	--	±80	--	deg

*1: Color Temperature=2870°K Standard Tungsten Lamp.

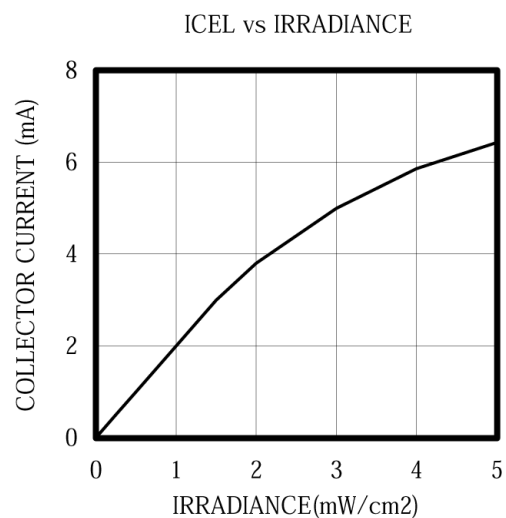
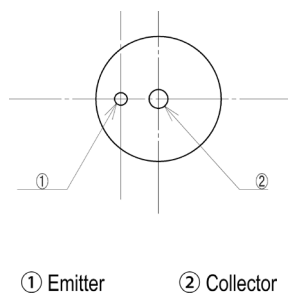
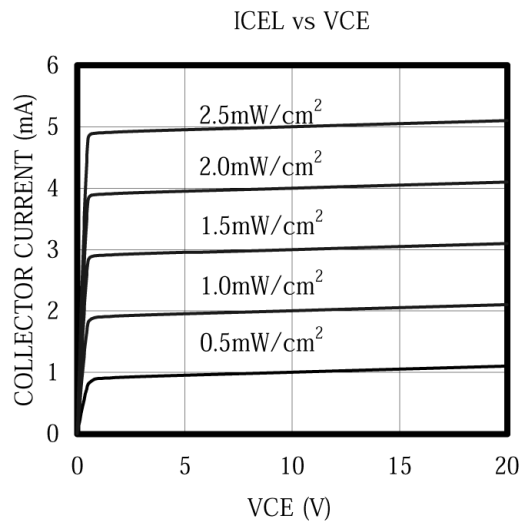
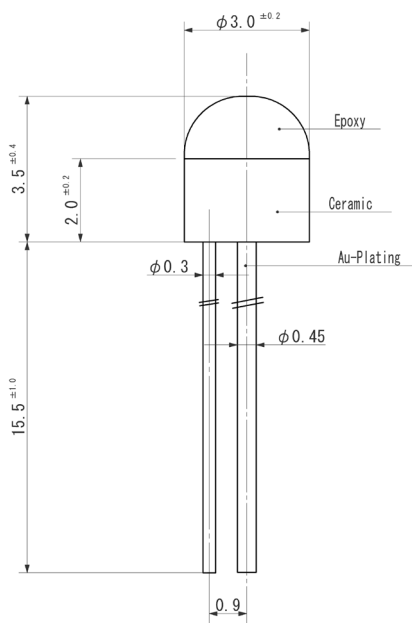

Unit: mm, Tolerance: ± 0.2

ANGULAR DISPLACEMENT

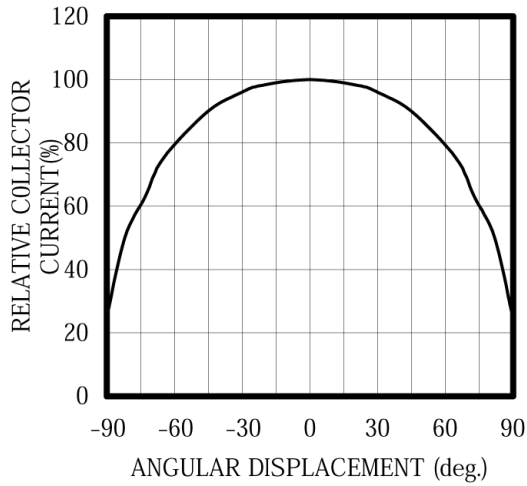

THERMAL DERATING CURVE

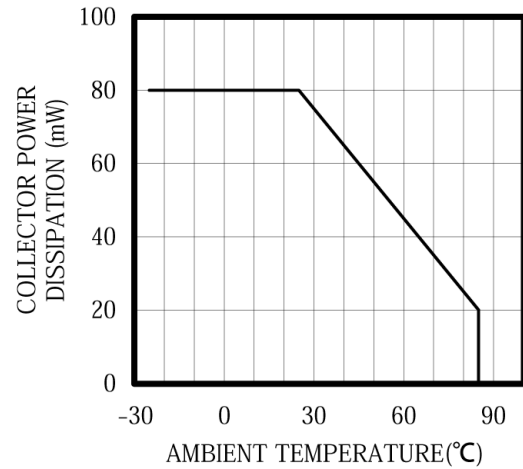

RELATIVE RESPONSE vs λ

