

UF4001 ... UF4007

Ultrafast Switching Silicon Rectifier Diodes – Ultraschnelle Silizium-Gleichrichterdioden

Version 2013-01-21

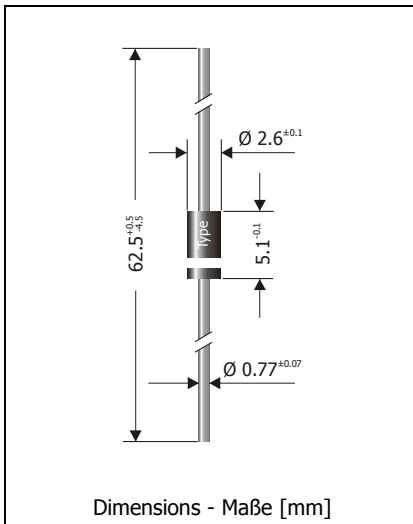

Nominal current Nennstrom	1 A
Repetitive peak reverse voltage Periodische Spitzensperrspannung	50...1000 V
Plastic case Kunststoffgehäuse	~DO-41 ~DO-204AC
Weight approx. Gewicht ca.	0.4 g
Plastic material has UL classification 94V-0 Gehäusematerial UL94V-0 klassifiziert	
Standard packaging taped in ammo pack Standard Lieferform gegurtet in Ammo-Pack	



Maximum ratings

Grenzwerte

Type Typ	Repetitive peak reverse voltage Periodische Spitzensperrspannung V_{RRM} [V]	Surge peak reverse voltage Stoßspitzensperrspannung V_{RSM} [V]
UF4001	50	50
UF4002	100	100
UF4003	200	200
UF4004	400	400
UF4005	600	600
UF4006	800	800
UF4007	1000	1000

Max. average forward rectified current, R-load Dauergrenzstrom in Einwegschaltung mit R-Last	$T_A = 50^\circ\text{C}$	I_{FAV}	1 A ¹⁾
Repetitive peak forward current Periodischer Spitzenstrom	$f > 15$ Hz	I_{FRM}	10 A ¹⁾
Peak forward surge current, 50/60 Hz half sine-wave Stoßstrom für eine 50/60 Hz Sinus-Halbwelle	$T_A = 25^\circ\text{C}$	I_{FSM}	30/33 A
Rating for fusing – Grenzlastintegral, $t < 10$ ms	$T_A = 25^\circ\text{C}$	i^2t	4.5 A ² s
Junction temperature – Sperrschichttemperatur		T_j	-50...+175°C
Storage temperature – Lagerungstemperatur		T_s	-50...+175°C

1 Valid, if leads are kept at ambient temperature at a distance of 10 mm from case
Gültig, wenn die Anschlussdrähte in 10 mm Abstand vom Gehäuse auf Umgebungstemperatur gehalten werden

Characteristics
Kennwerte

Type Typ	Reverse recovery time Sperrverzugszeit	Forward voltage Durchlass-Spannung		
	t_{rr} [ns] ¹⁾	V_F [V]	at / bei	$I_F =$ [A]
UF4001 ... UF4003	< 50	< 1.0		1
UF4004	< 50	< 1.25		1
UF4005 ... UF4007	< 75	< 1.7		1

Leakage current Sperrstrom	$T_j = 25^\circ\text{C}$ $T_j = 100^\circ\text{C}$	$V_R = V_{RRM}$ $V_R = V_{RRM}$	I_R I_R	< 5 μA < 50 μA
Thermal resistance junction to ambient air Wärmewiderstand Sperrschicht – umgebende Luft			R_{thA}	< 45 K/W ²⁾
Thermal resistance junction to leads Wärmewiderstand Sperrschicht – Anschlussdraht			R_{thL}	< 15 K/W

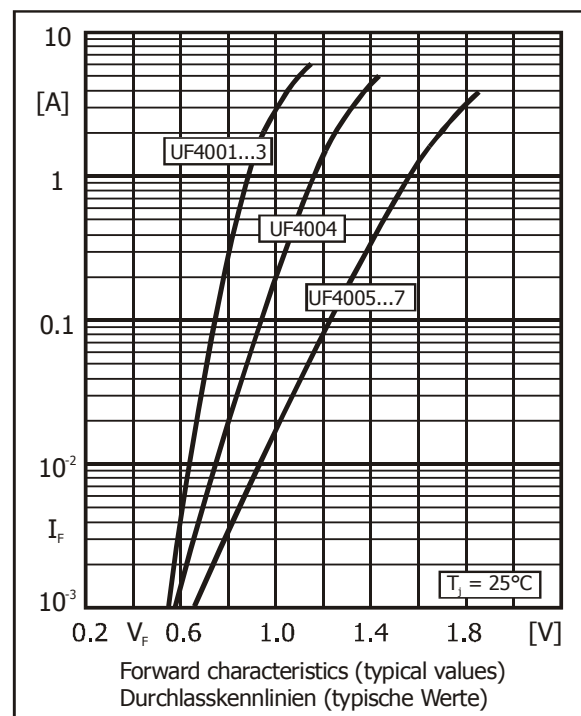
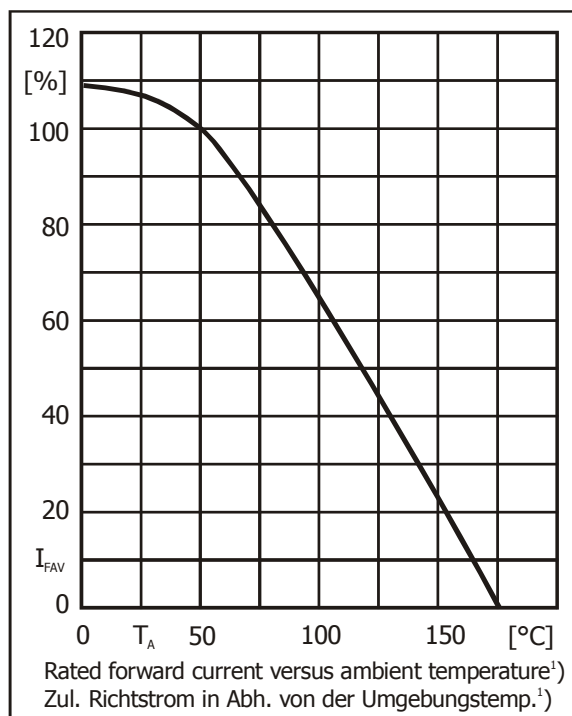

1 $I_F = 0.5$ A through/über $I_R = 1$ A to/auf $I_R = 0.25$ A

2 Valid, if leads are kept at ambient temperature at a distance of 10 mm from case
 Gültig, wenn die Anschlussdrähte in 10 mm Abstand vom Gehäuse auf Umgebungstemperatur gehalten werden