

KBPC600 ... KBPC610

Silicon-Bridge-Rectifiers Silizium-Brückengleichrichter

Version 2012-10-08

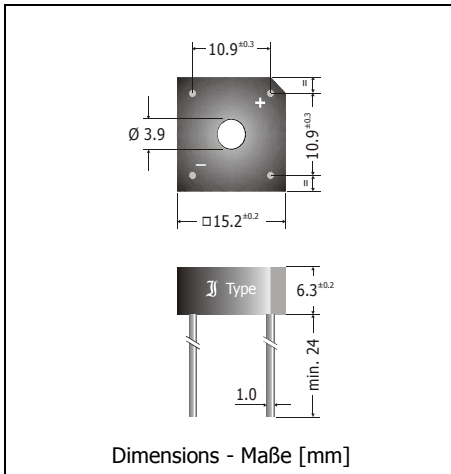

Nominal current Nennstrom	6 A
Alternating input voltage Eingangswchelspannung	35...700 V
Plastic case Kunststoffgehäuse	15.2 x 15.2 x 6.3 [mm]
Weight approx. Gewicht ca.	3.5 g
Plastic material has UL classification 94V-0 Gehäusematerial UL94V-0 klassifiziert	
Standard packaging bulk Standard Lieferform lose im Karton	



Recognized Product – Underwriters Laboratories Inc.® File E175067
Anerkanntes Produkt – Underwriters Laboratories Inc.® Nr. E175067

Maximum ratings**Grenzwerte**

Type Typ	Max. alternating input voltage Max. Eingangswchelspannung V_{VRMS} [V]	Repetitive peak reverse voltage Periodische Spitzensperrspannung V_{RRM} [V] ¹⁾
KBPC600	35	50
KBPC601	70	100
KBPC602	140	200
KBPC604	280	400
KBPC606	420	600
KBPC608	560	800
KBPC610	700	1000

Repetitive peak forward current Periodischer Spitzenstrom	$f > 15$ Hz	I_{FRM}	30 A ²⁾
Peak forward surge current, 50/60 Hz half sine-wave Stoßstrom für eine 50/60 Hz Sinus-Halbwelle	$T_A = 25^\circ\text{C}$	I_{FSM}	110/125 A
Rating for fusing, $t < 10$ ms Grenzlastintegral, $t < 10$ ms	$T_A = 25^\circ\text{C}$	i^2t	64 A ² s
Operating junction temperature – Sperrschichttemperatur Storage temperature – Lagerungstemperatur		T_j T_s	-50...+150°C -50...+150°C

1 Valid for one branch – Gültig für einen Brückenweig

2 Valid, if leads are kept at ambient temperature $T_A = 50^\circ\text{C}$ at a distance of 5 mm from case
Gültig, wenn die Anschlussdrähte in 5 mm vom Gehäuse auf Umgebungstemperatur $T_A = 50^\circ\text{C}$ gehalten werden

Characteristics
Kennwerte

Max. rectified current without cooling fin Dauergrenzstrom ohne Kühlblech	$T_A = 50^\circ\text{C}$	R-load C-load	I_{FAV} I_{FAV}	3.8 A ¹⁾ 3.0 A ¹⁾
Max. rectified current with cooling fin 300 cm ² Dauergrenzstrom mit Kühlblech 300 cm ²	$T_A = 50^\circ\text{C}$	R-load C-load	I_{FAV} I_{FAV}	6.0 A 4.8 A
Forward voltage – Durchlass-Spannung	$T_j = 25^\circ\text{C}$	$I_F = 3\text{ A}$	V_F	< 1.2 V ²⁾
Leakage current – Sperrstrom	$T_j = 25^\circ\text{C}$	$V_R = V_{RRM}$	I_R	< 5 μA
Thermal resistance junction to case Wärmewiderstand Sperrschicht – Gehäuse			R_{thC}	< 3.3 K/W
Admissible torque for mounting Zulässiges Anzugsdrehmoment			M 4	9 \pm 10% lb.in. 1 \pm 10% Nm

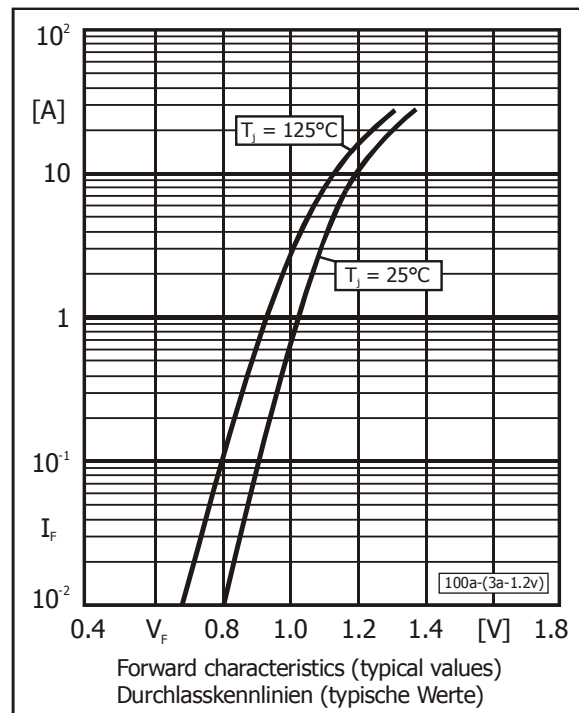
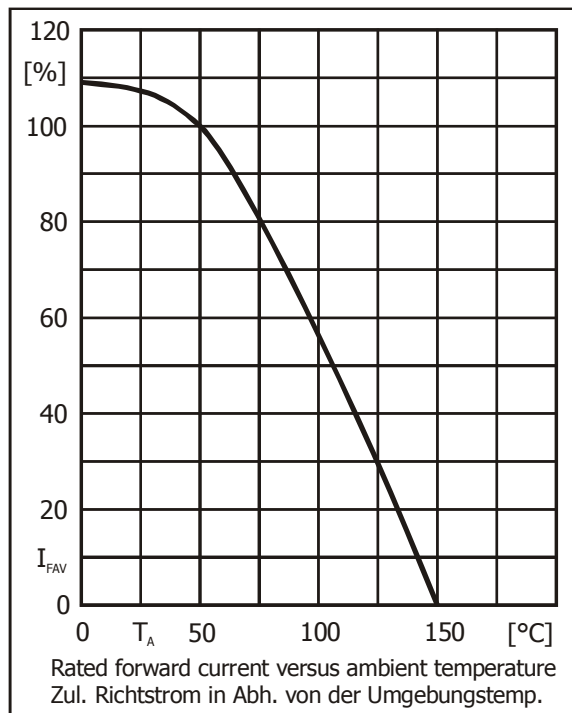

- Valid, if leads are kept at ambient temperature at a distance of 5 mm from case
Gültig, wenn die Anschlussdrähte in 5 mm Abstand vom Gehäuse auf Umgebungstemperatur gehalten werden
- Valid for one branch – Gültig für einen Brückenweig