

# SKiIP 02NAC066V3

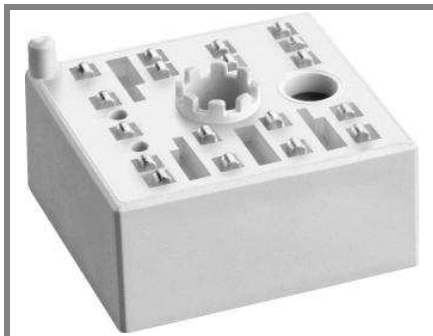

MiniSKiIP<sup>®</sup>0

3-phase bridge rectifier +  
3-phase bridge inverter

SKiIP 02NAC066V3

## Features

- Trench IGBTs
- Robust and soft freewheeling diodes in CAL technology
- Highly reliable spring contacts for electrical connections
- UL recognised file no. E63532

## Typical Applications\*

- Inverter up to 5 kVA
- Typical motor power 2,2 kW

## Remarks

- Case temperature limited to  $T_C = 125^\circ\text{C}$  max.
- Product reliability results are valid for  $T_j = 150^\circ\text{C}$
- SC data:  $t_p \leq 6 \mu\text{s}$ ;  $V_{GE} \leq 15 \text{ V}$ ;  $T_j = 150^\circ\text{C}$ ;  $V_{CC} = 360 \text{ V}$
- $V_{CEsat}$ ,  $V_F$  = chip level values

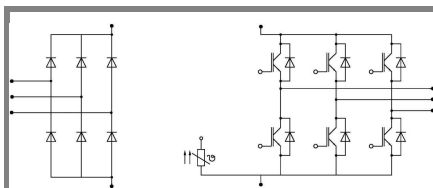

NAC

Absolute Maximum Ratings		$T_S = 25^\circ\text{C}$ , unless otherwise specified	
Symbol	Conditions	Values	Units
<b>IGBT - Inverter</b>			
$V_{CES}$		600	V
$I_C$	$T_S = 25 (70)^\circ\text{C}$ , $T_j = 150^\circ\text{C}$	19 (14)	A
$I_C$	$T_S = 25 (70)^\circ\text{C}$ , $T_j = 175^\circ\text{C}$	20 (16)	A
$I_{CRM}$	$t_p = 1 \text{ ms}$	20	A
$V_{GES}$		$\pm 20$	V
<b>Diode - Inverter</b>			
$I_F$	$T_S = 25 (70)^\circ\text{C}$ , $T_j = 150^\circ\text{C}$	20 (15)	A
$I_F$	$T_S = 25 (70)^\circ\text{C}$ , $T_j = 175^\circ\text{C}$	20 (18)	A
$I_{FRM}$	$t_p = 1 \text{ ms}$	20	A
<b>Diode - Rectifier</b>			
$V_{RRM}$		800	V
$I_F$	$T_S = 70^\circ\text{C}$	35	A
$I_{FSM}$	$t_p = 10 \text{ ms}$ , $\sin 180^\circ$ , $T_j = 25^\circ\text{C}$	220	A
$i^2t$	$t_p = 10 \text{ ms}$ , $\sin 180^\circ$ , $T_j = 25^\circ\text{C}$	240	$\text{A}^2\text{s}$
$I_{tRMS}$	per power terminal (20 A / spring)	20	A
$T_j$	IGBT, Diode	-40...+175	$^\circ\text{C}$
$T_{stg}$		-40...+125	$^\circ\text{C}$
$V_{isol}$	AC, 1 min.	2500	V

Characteristics		$T_S = 25^\circ\text{C}$ , unless otherwise specified			
Symbol	Conditions	min.	typ.	max.	Units
<b>IGBT - Inverter</b>					
$V_{CE(sat)}$	$I_{Cnom} = 10 \text{ A}$ , $T_j = 25 (150)^\circ\text{C}$	1,1	1,45 (1,65)	1,85 (2,05)	V
$V_{GE(th)}$	$V_{GE} = V_{CE}$ , $I_C = 1 \text{ mA}$		5,8		V
$V_{CE(TO)}$	$T_j = 25 (150)^\circ\text{C}$		0,9 (0,7)	1,1 (1)	V
$r_{CE}$	$T_j = 25 (150)^\circ\text{C}$		60 (100)	80 (110)	$\text{m}\Omega$
$C_{ies}$	$V_{CE} = 25 \text{ V}$ , $V_{GE} = 0 \text{ V}$ , $f = 1 \text{ MHz}$		0,58		nF
$C_{oes}$	$V_{CE} = 25 \text{ V}$ , $V_{GE} = 0 \text{ V}$ , $f = 1 \text{ MHz}$		0,12		nF
$C_{res}$	$V_{CE} = 25 \text{ V}$ , $V_{GE} = 0 \text{ V}$ , $f = 1 \text{ MHz}$		0,04		nF
$R_{CC+EE'}$	spring contact-chip $T_S = 25 (150)^\circ\text{C}$				$\text{m}\Omega$
$R_{th(j-s)}$	per IGBT		2		K/W
$t_{d(on)}$	under following conditions		25		ns
$t_r$	$V_{CC} = 300 \text{ V}$ , $V_{GE} = \pm 15 \text{ V}$		25		ns
$t_{d(off)}$	$I_{Cnom} = 10 \text{ A}$ , $T_j = 150^\circ\text{C}$		190		ns
$t_f$	$R_{Gon} = R_{Goff} = 39 \Omega$		40		ns
$E_{on} (E_{off})$	inductive load		0,5 (0,3)		mJ
<b>Diode - Inverter</b>					
$V_F = V_{EC}$	$I_F = 10 \text{ A}$ , $T_j = 25 (150)^\circ\text{C}$		1,3 (1,3)	1,6 (1,6)	V
$V_{(TO)}$	$T_j = 25 (150)^\circ\text{C}$		0,9 (0,8)	1 (0,9)	V
$r_T$	$T_j = 25 (150)^\circ\text{C}$		40 (50)	60 (70)	$\text{m}\Omega$
$R_{th(j-s)}$	per diode		2,5		K/W
$I_{RRM}$	under following conditions		15,8		A
$Q_{rr}$	$I_{Fnom} = 10 \text{ A}$ , $V_R = 300 \text{ V}$		1,5		$\mu\text{C}$
$E_{rr}$	$V_{GE} = 0 \text{ V}$ , $T_j = 150^\circ\text{C}$		0,5		mJ
	$di_F/dt = 810 \text{ A}/\mu\text{s}$				
<b>Diode - Rectifier</b>					
$V_F$	$I_{Fnom} = 15 \text{ A}$ , $T_j = 25^\circ\text{C}$		1,1		V
$V_{(TO)}$	$T_j = 150^\circ\text{C}$		0,8		V
$r_T$	$T_j = 150^\circ\text{C}$		20		$\text{m}\Omega$
$R_{th(j-s)}$	per diode		1,5		K/W
<b>Temperature Sensor</b>					
$R_{ts}$	3 %, $T_r = 25 (100)^\circ\text{C}$		1000(1670)		$\Omega$
<b>Mechanical Data</b>					
w			21,5		g
$M_s$	Mounting torque	2		2,5	Nm

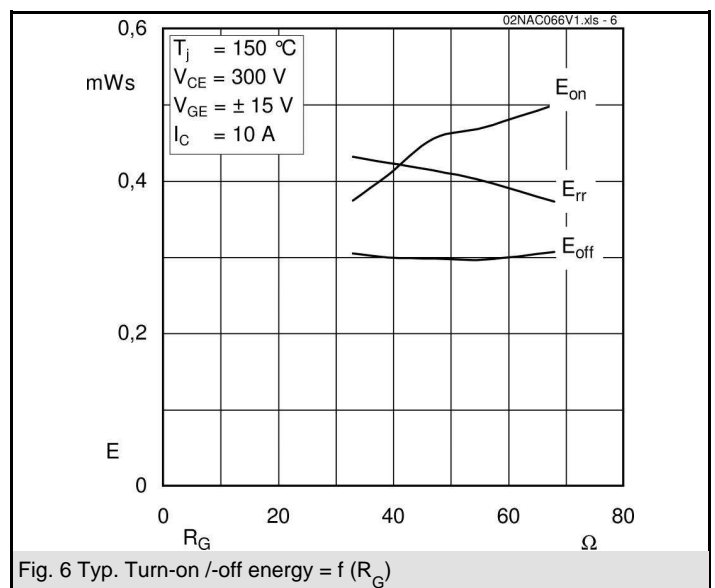
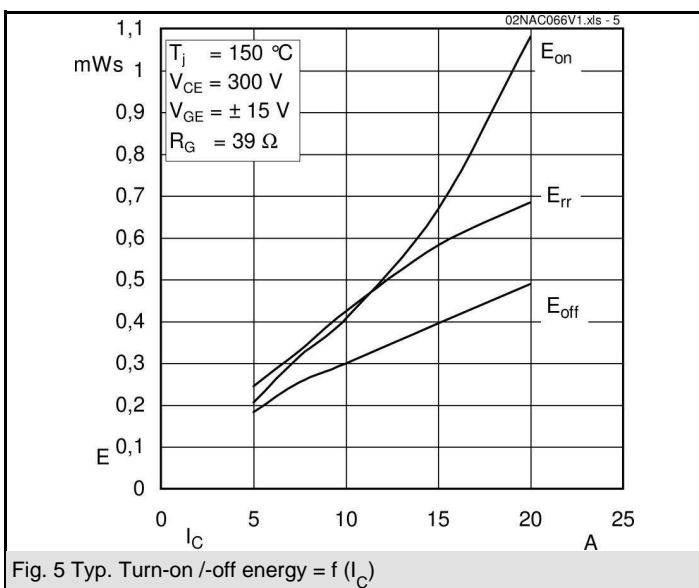
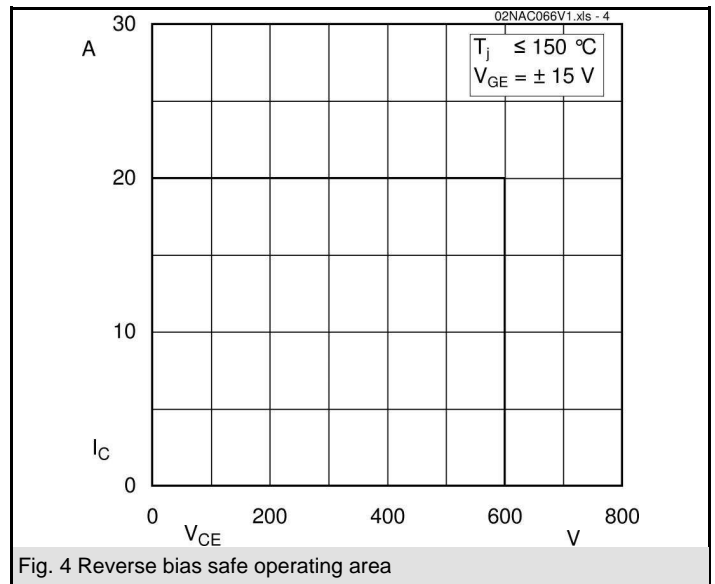
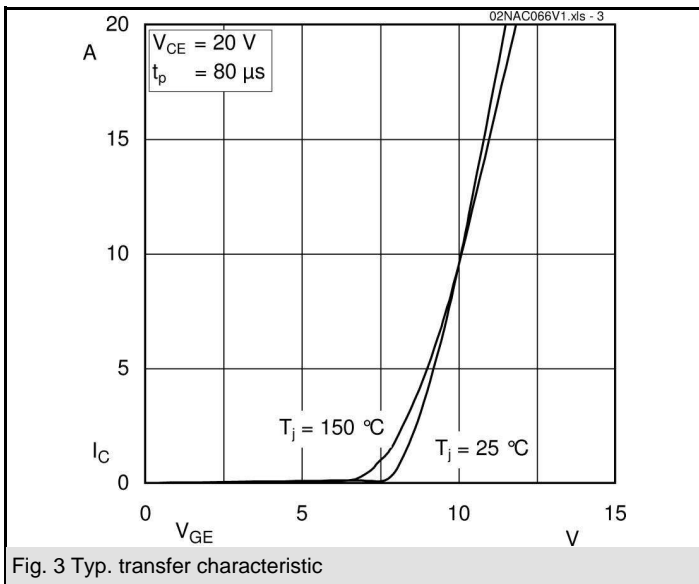
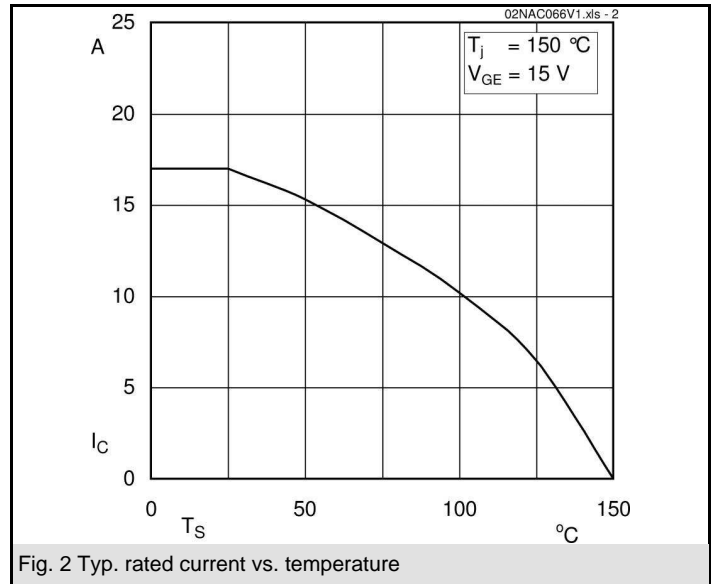
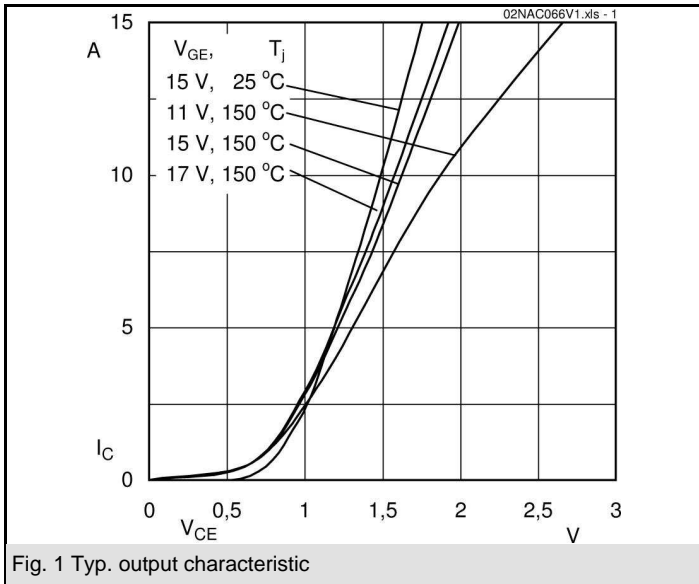

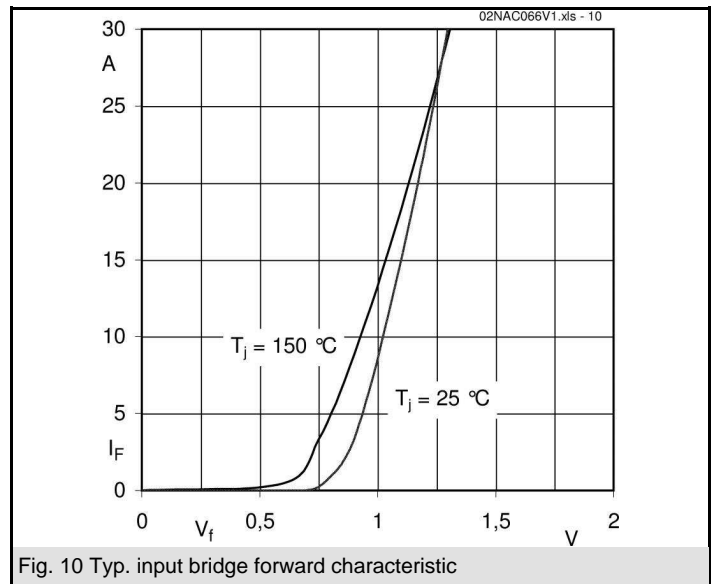
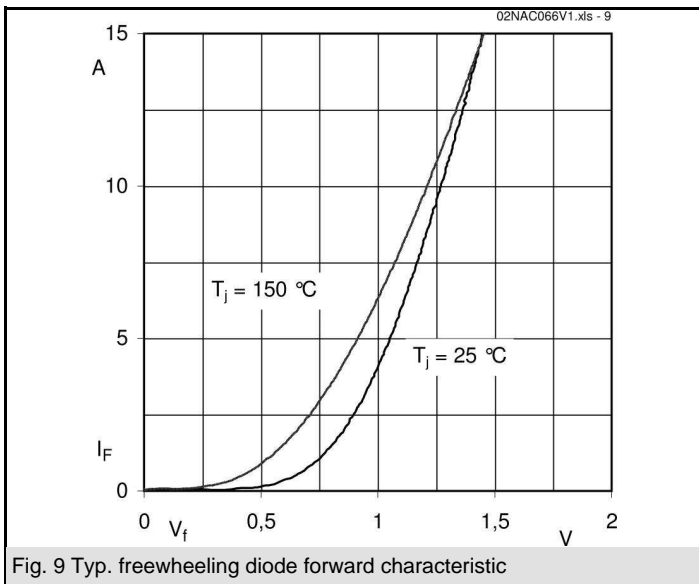
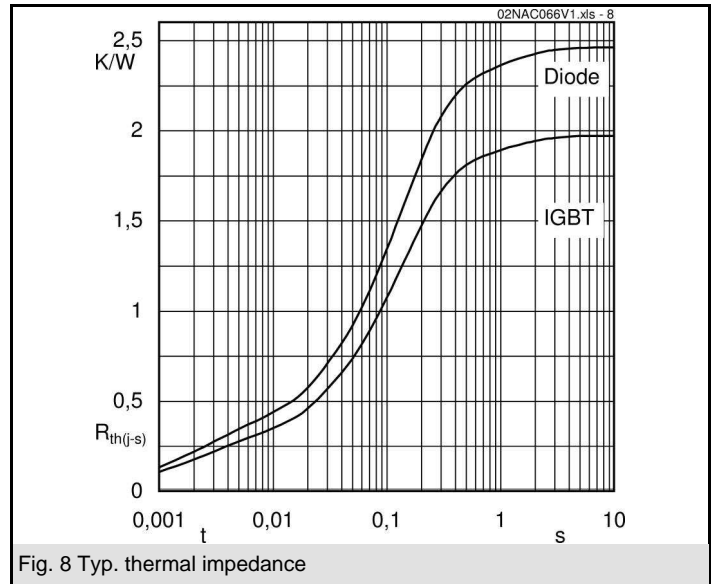
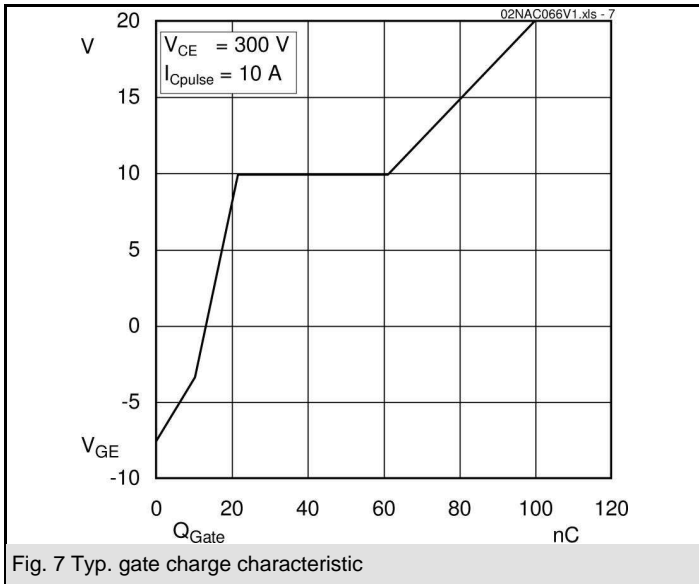

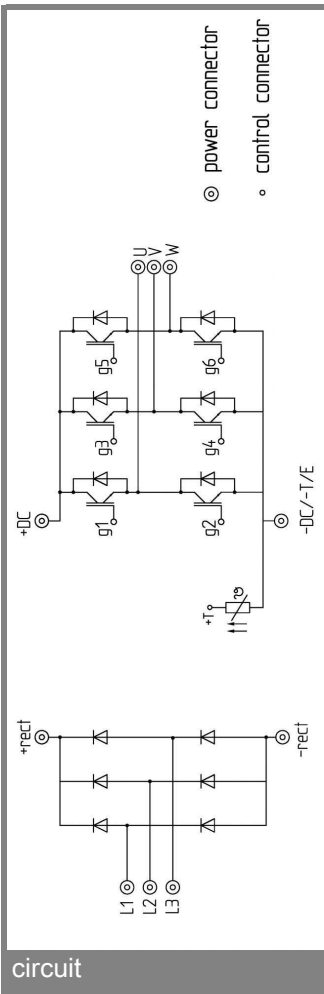

circuit

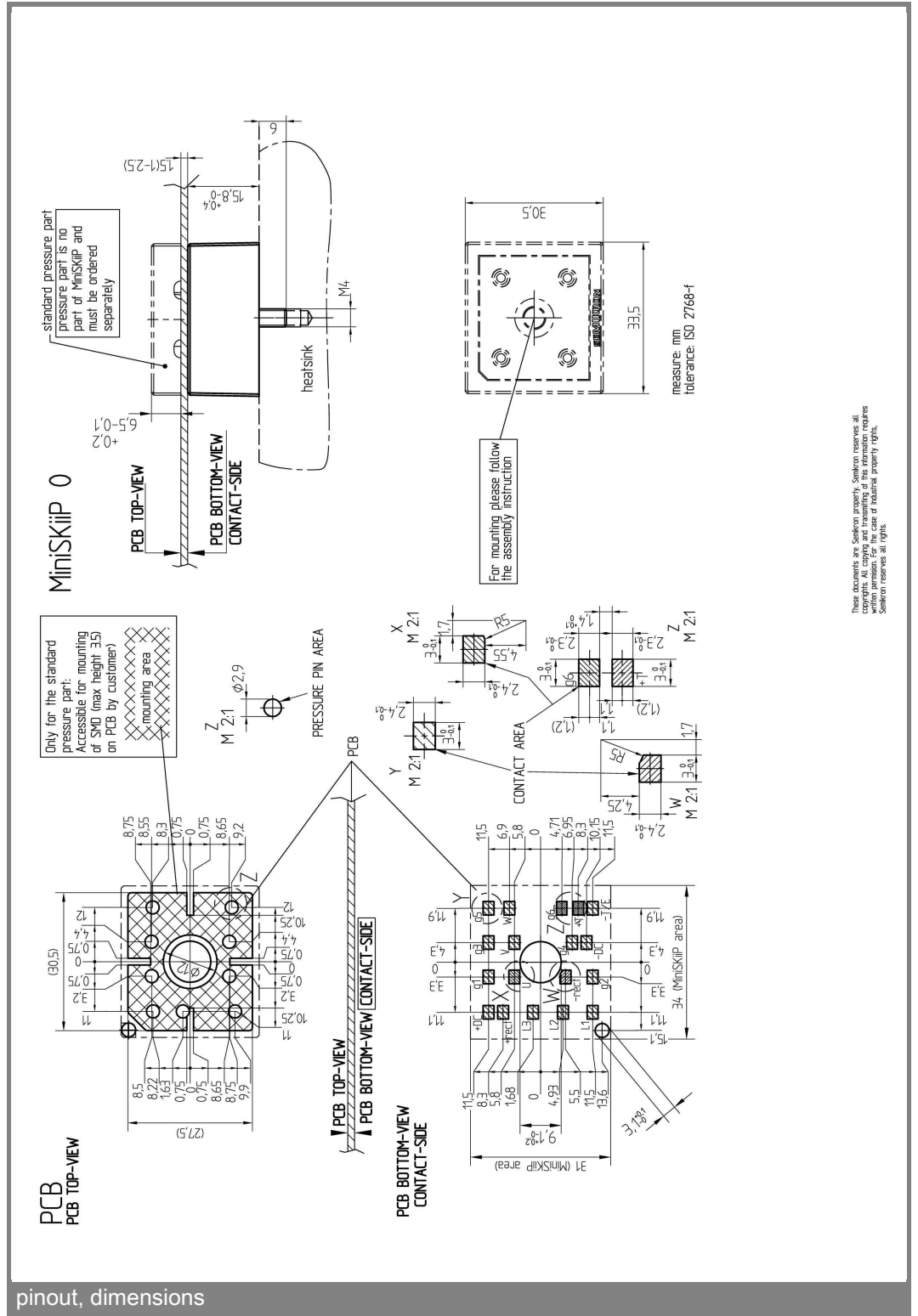

These documents are customer property. Customer reserves all copyrights. All copying and translating of this information requires written permission. For the case of industrial property rights, SEMIKRON reserves all rights.

This is an electrostatic discharge sensitive device (ESDS), international standard IEC 60747-1, Chapter IX.

\* The specifications of our components may not be considered as an assurance of component characteristics. Components have to be tested for the respective application. Adjustments may be necessary. The use of SEMIKRON products in life support appliances and systems is subject to prior specification and written approval by SEMIKRON. We therefore strongly recommend prior consultation of our personal.