



SEMIPACK® 3

Thyristor Modules

SKKT 273/16 E

Features

- Industrial standard package
- Electrically insulated base plate
- Heat transfer through aluminum oxide ceramic insulated metal base plate
- Chip soldered on direct copper bonded Al₂O₃ ceramic
- Thyristor with center gate
- UL recognition applied for file no. E63532

Typical Applications*

- DC motor control (e. g. for machine tools)
- Temperature control (e. g. for ovens, chemical processes)
- Professional light dimming (studios, theaters)

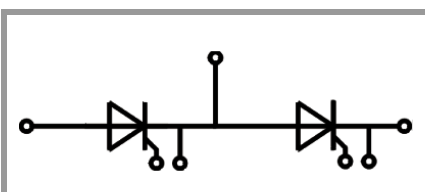

SKKT

Absolute Maximum Ratings				
Symbol	Conditions		Values	Unit
Chip				
I _{T(AV)}	sinus 180°	T _c = 85 °C	274	A
		T _c = 100 °C	204	A
I _{TSM}	10 ms	T _j = 25 °C	9000	A
		T _j = 130 °C	8000	A
i ² t	10 ms	T _j = 25 °C	405000	A ² s
		T _j = 130 °C	320000	A ² s
V _{RSM}			1700	V
V _{RRM}			1600	V
V _{DRM}			1600	V
(di/dt) _{cr}	T _j = 130 °C		130	A/μs
(dv/dt) _{cr}	T _j = 130 °C		1000	V/μs
T _j			-40 ... 130	°C
Module				
T _{stg}			-40 ... 125	°C
V _{isol}	a.c.; 50 Hz; r.m.s.	1 min	3000	V
		1 s	3600	V

Characteristics						
Symbol	Conditions		min.	typ.	max.	Unit
Chip						
V _T	T _j = 25 °C, I _T = 750 A				1.6	V
V _{T(TO)}	T _j = 130 °C				0.9	V
r _T	T _j = 130 °C				0.92	mΩ
I _{DD} ; I _{RD}	T _j = 130 °C, V _{DD} = V _{DRM} ; V _{RD} = V _{RRM}				100	mA
t _{gd}	T _j = 25 °C, I _G = 1 A, di _G /dt = 1 A/μs			1		μs
t _{gr}	V _D = 0.67 * V _{DRM}			2		μs
t _q	T _j = 130 °C			150		μs
I _H	T _j = 25 °C			150	500	mA
I _L	T _j = 25 °C, R _G = 33 Ω			300	2000	mA
V _{GT}	T _j = 25 °C, d.c.		2			V
I _{GT}	T _j = 25 °C, d.c.		150			mA
V _{GD}	T _j = 130 °C, d.c.				0.25	V
I _{GD}	T _j = 130 °C, d.c.				10	mA
R _{th(j-c)}	cont.	per chip			0.104	K/W
		per module			0.052	K/W
R _{th(j-c)}	sin. 180°	per chip			0.108	K/W
		per module			0.054	K/W
R _{th(j-c)}	rec. 120°	per chip			0.122	K/W
		per module			0.061	K/W
Module						
R _{th(c-s)}	chip			0.08	0.08	K/W
	module			0.04		K/W
M _s	to heatsink M5		4.25		5.75	Nm
M _t	to heatsink M8		7.65		10.34	Nm
a					5 * 9,81	m/s ²
w				410		g

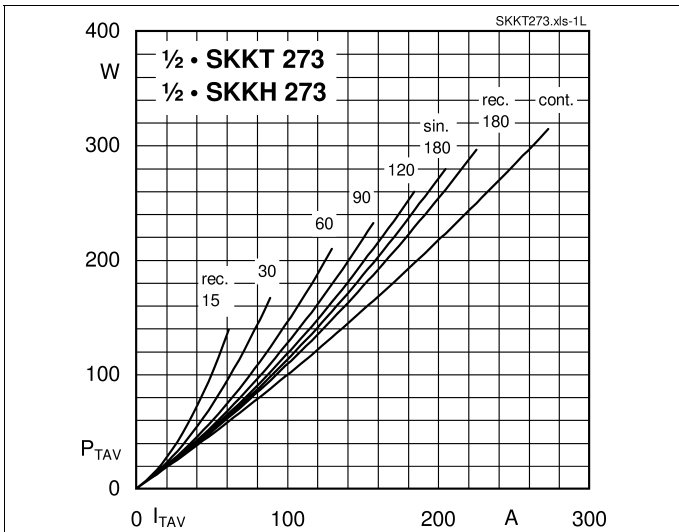

Fig. 1L: Power dissipation per thyristor/diode vs. on-state current

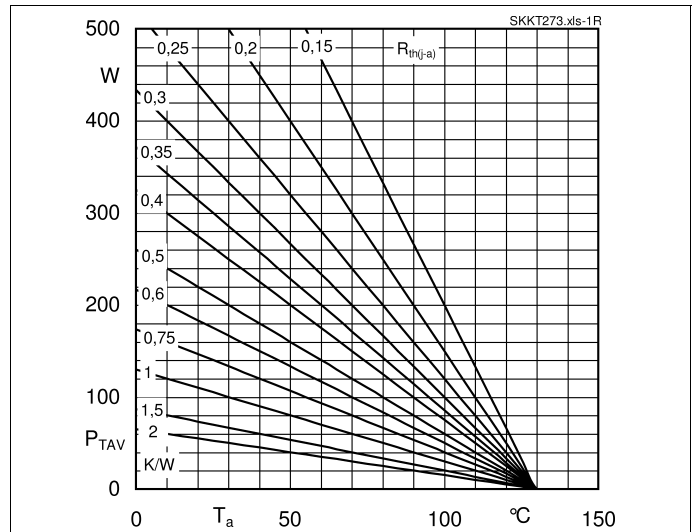

Fig. 1R: Power dissipation per thyristor/diode vs. ambient temperature

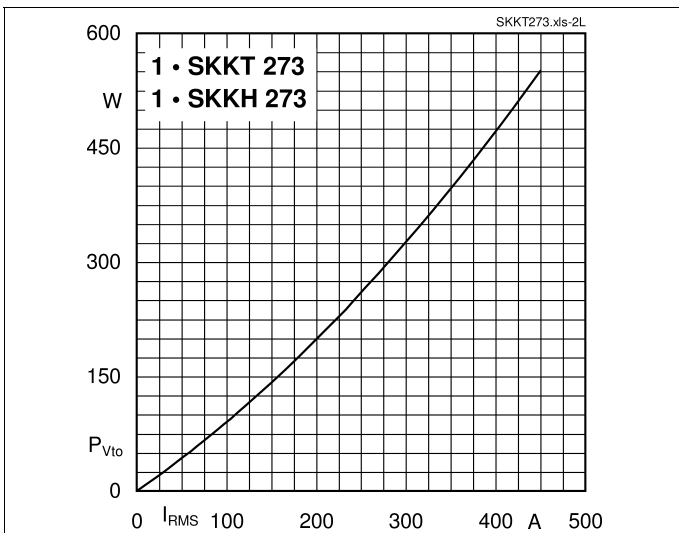

Fig. 2L: Power dissipation of one module vs. rms current

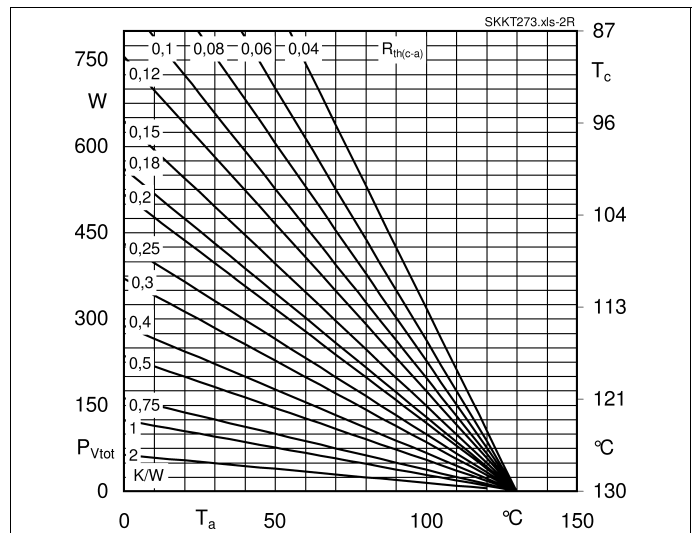

Fig. 2R: Power dissipation of one module vs. case temperature

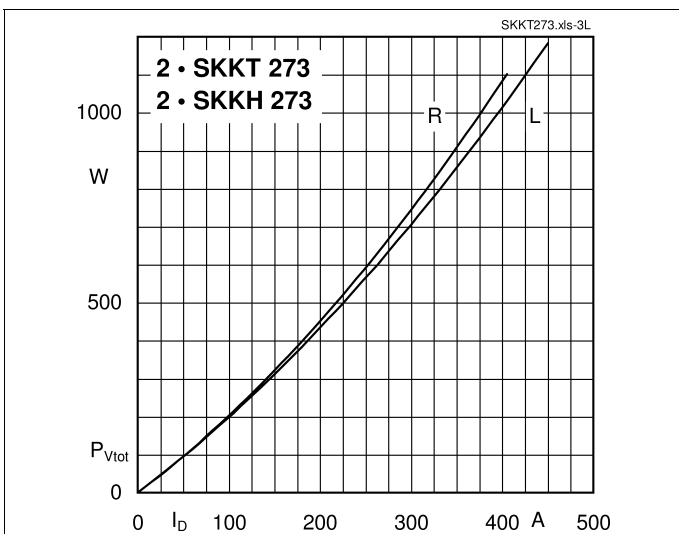

Fig. 3L: Power dissipation of two modules vs. direct current

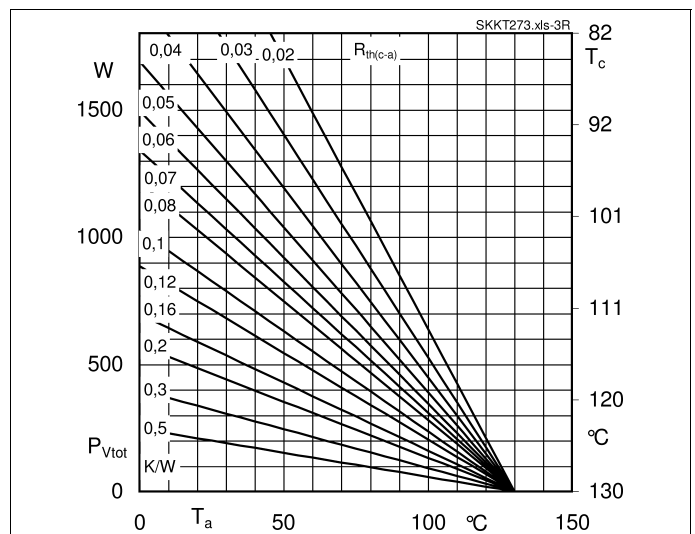

Fig. 3R: Power dissipation of two modules vs. case temperature

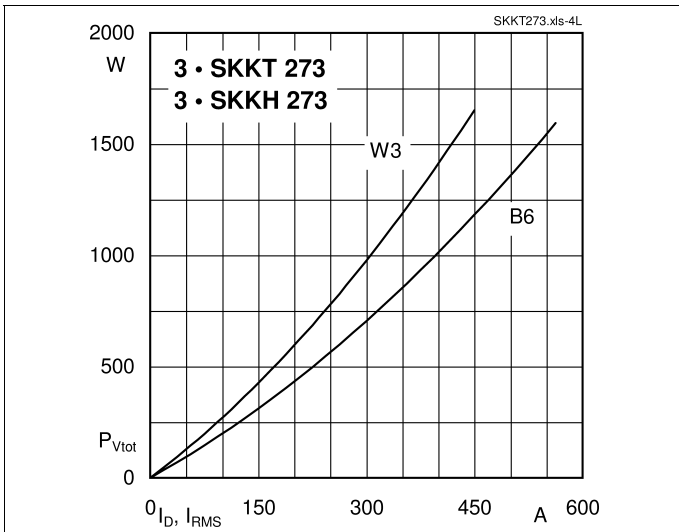

Fig. 4L: Power dissipation of three modules vs. direct and rms current

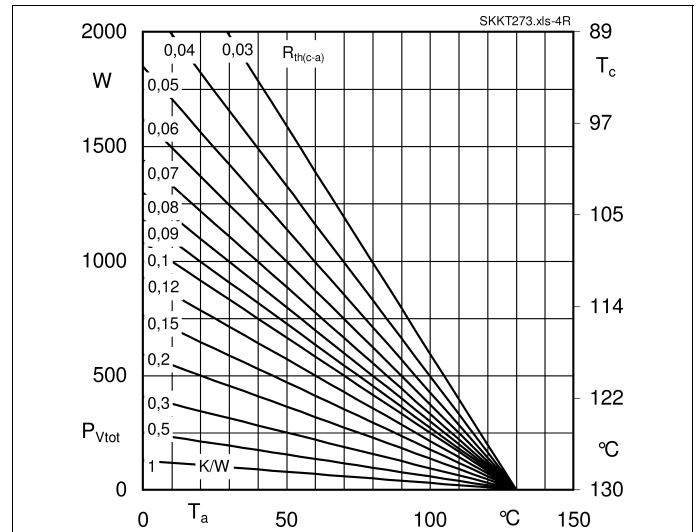

Fig. 4R: Power dissipation of three modules vs. case temperature

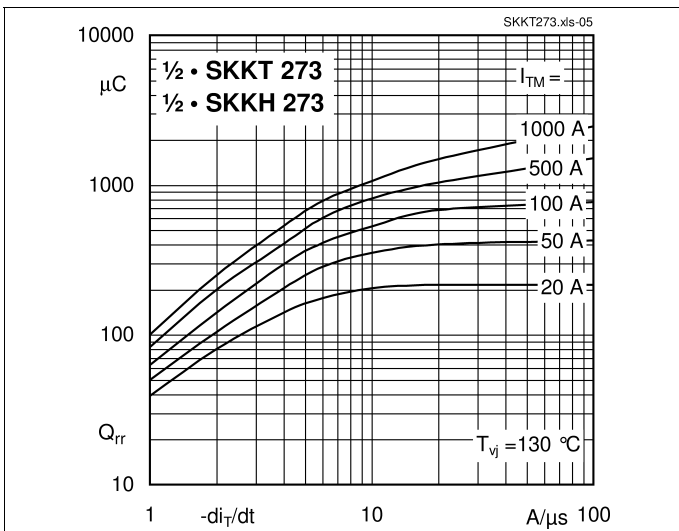

Fig. 5: Recovered charge vs. current decrease

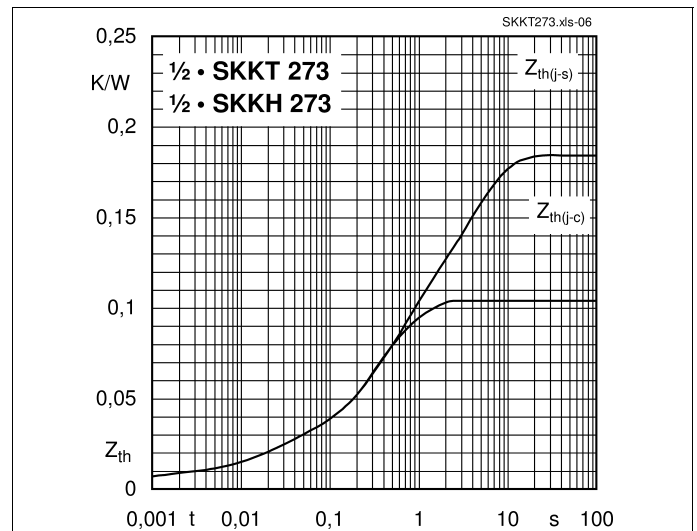

Fig. 6: Transient thermal impedance vs. time

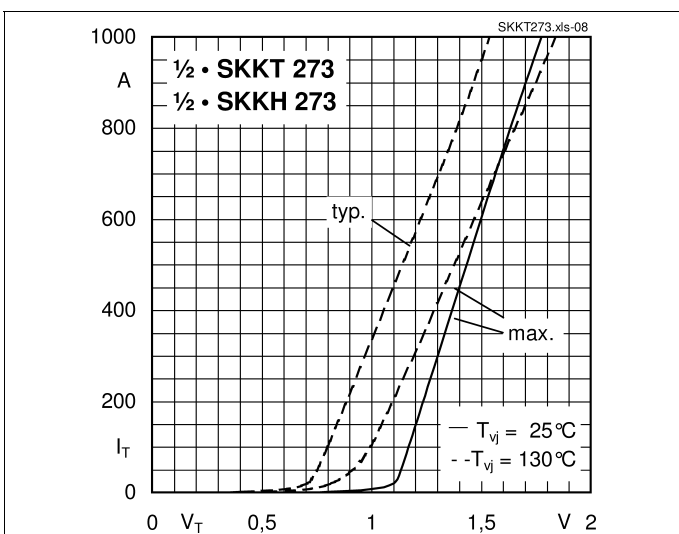

Fig. 7: On-state characteristics

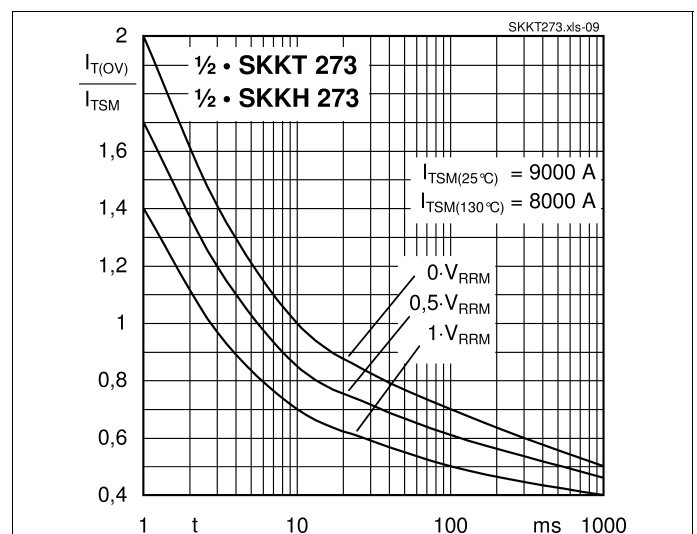

Fig. 8: Surge overload current vs. time

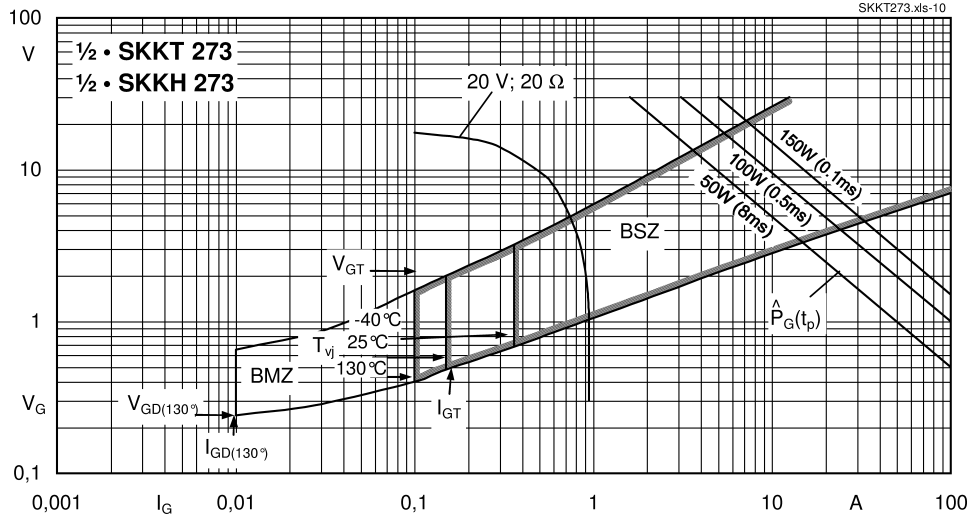
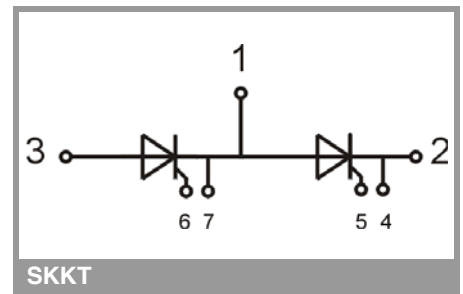
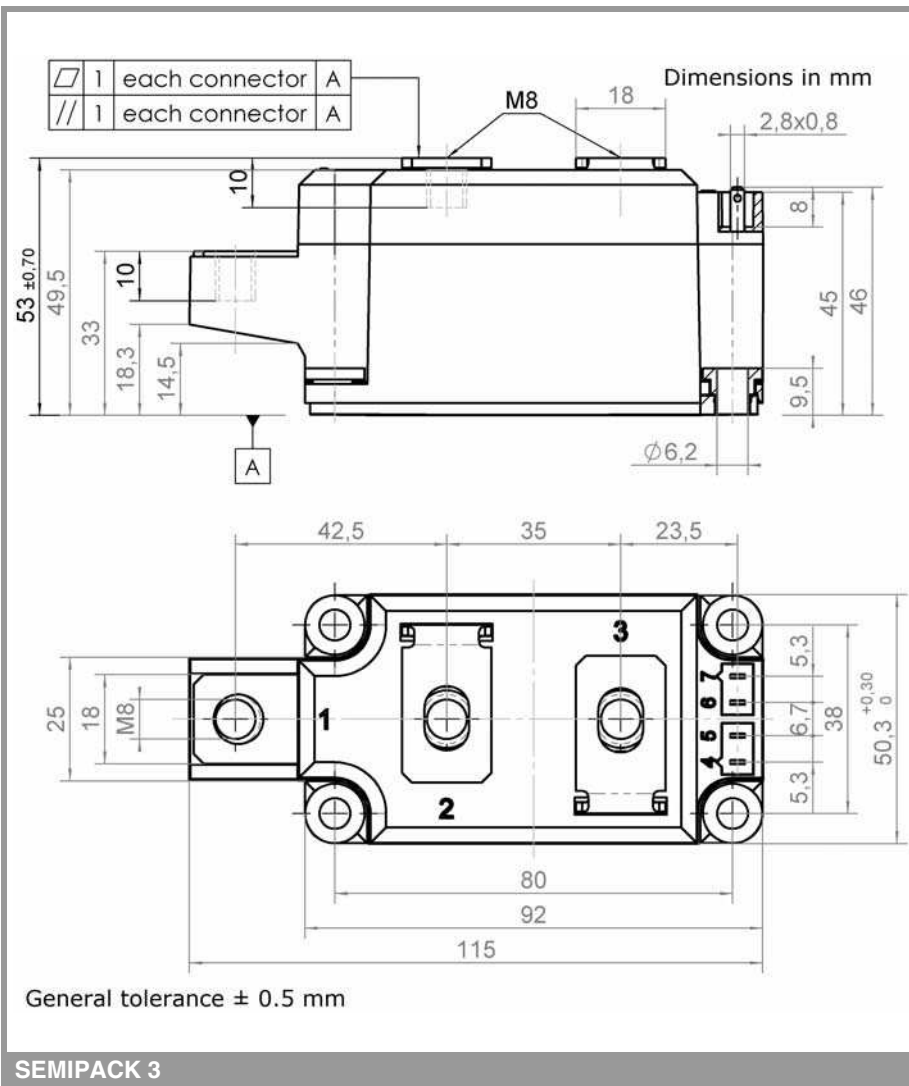

Fig. 9: Gate trigger characteristics



This is an electrostatic discharge sensitive device (ESDS), international standard IEC 60747-1, Chapter IX

* The specifications of our components may not be considered as an assurance of component characteristics. Components have to be tested for the respective application. Adjustments may be necessary. The use of SEMIKRON products in life support appliances and systems is subject to prior specification and written approval by SEMIKRON. We therefore strongly recommend prior consultation of our staff.