

# 5.0SMLJ11A THRU 5.0SMLJ170CA

## Transient Voltage Suppressor 11 to 170 Volts 5000 Watt

### Features

- Halogen free available upon request by adding suffix "-HF"
- For surface mount application in order to optimize board space
- Low profile package
- Lead Free Finish/Rohs Compliant (Note1) ("P" Suffix designates Compliant. See ordering information)
- Glass passivated junction
- Excellent clamping capability
- Repetition Rate( duty cycle): 0.01%
- Fast response time: typical less than 1ps from 0V to BV min
- Typical I<sub>D</sub> less than 1uA above 10V
- High temperature soldering: 260°C/10 seconds at terminals
- Low Inductance
- Built in strain relief
- UL Recognized File # E331408

### Mechanical Data

- Epoxy meets UL 94 V-0 flammability rating
- Moisture Sensitivity Level 1
- Terminals: solderable per MIL-STD-750, Method 2026
- Polarity: Color band denotes positive end( cathode) except Bi-directional types.
- Standard packaging: 16mm tape per ( EIA 481).
- Weight: 0.007 ounce, 0.21 gram

### Maximum Ratings @ 25°C Unless Otherwise Specified

Peak Pulse Current on 10/1000us waveform(Note2)	I <sub>PPM</sub>	See page 2,3	Amps
Peak Pulse Power Dissipation on 10/1000us waveform(Note2,3)	P <sub>PPM</sub>	Minimum 5000	Watts
Power Dissipation on infinite heat sink at T <sub>L</sub> =75°C	P <sub>D</sub>	6.5	Watts
Operation And Storage Temperature Range	T <sub>J</sub> , T <sub>STG</sub>	-55°C to +175°C	

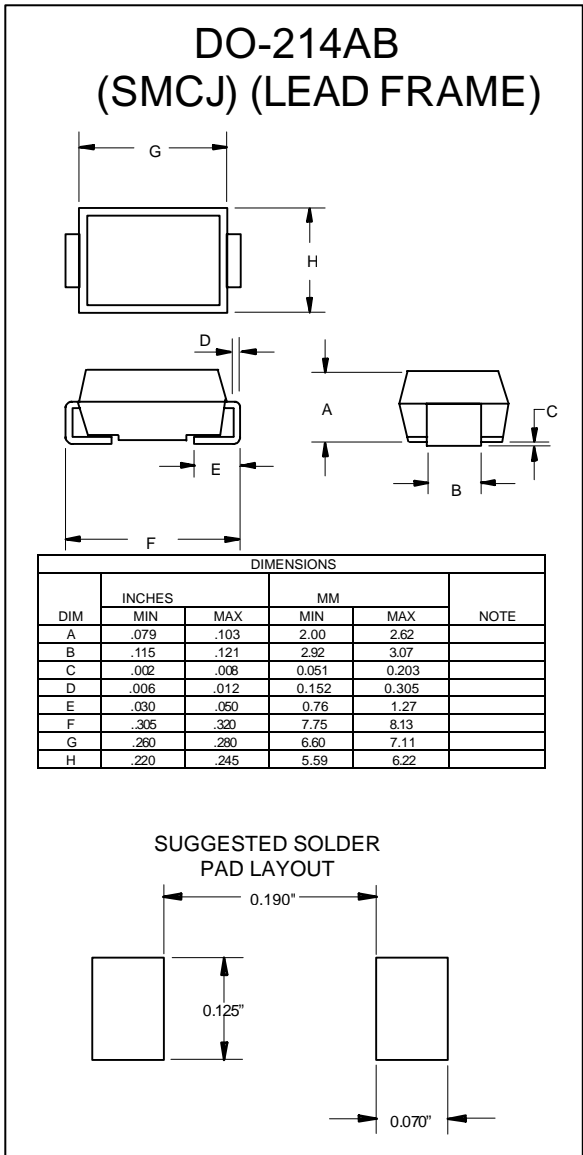

Note:

1. High Temperature Solder Exemptions Applied, see EU Directive Annex 7.
2. Non-repetitive current pulse and derated above T<sub>A</sub>=25°C
3. Mounted on 8.0mm<sup>2</sup> copper pads to each terminal.
4. 8.3ms, single half sine-wave or equivalent square wave, duty cycle=4 pulses per. Minutes maximum.

# 5.0SMLJ11A~ 5.0SMLJ170A

PART NUMBER	REVERSE STAND- OFF VOLTAGE $V_{RWM}(V)$	BREAKDOWN VOLTAGE $V_{BR}(V)$ MIN.@IT	BREAKDOWN VOLTAGE $V_{BR}(V)$ MAX.@IT	TEST CURRENT $I_T$ (mA)	MAXIMUM CLAMPING VOLTAGE @Ipp	PEAK PULSE CURRENT Ipp (A)	REVERSE LEAKAGE @ $V_{RWM}$	DEVICE MARKING CODE
					$V_C(V)$		$I_D(\mu A)$	
5.0SMLJ 11A	11	12.2	13.5	10	18.2	275	800	5PEN
5.0SMLJ 12A	12	13.3	14.7	10	19.9	252	800	5PEP
5.0SMLJ 13A	13	14.4	15.9	10	21.5	233	500	5PEQ
5.0SMLJ 14A	14	15.6	17.2	10	23.2	216	200	5PER
5.0SMLJ 15A	15	16.7	18.5	1	24.4	205	100	5PES
5.0SMLJ 16A	16	17.8	19.7	1	26	193	50	5PET
5.0SMLJ 17A	17	18.9	20.9	1	27.6	181	20	5PEU
5.0SMLJ 18A	18	20	22.1	1	29.2	172	10	5PEV
5.0SMLJ 20A	20	22.2	24.5	1	32.4	155	5	5PEW
5.0SMLJ 22A	22	24.4	26.9	1	35.5	141	5	5PEX
5.0SMLJ 24A	24	26.7	29.5	1	38.9	129	5	5PEZ
5.0SMLJ 26A	26	28.9	31.9	1	42.1	119	5	5PFE
5.0SMLJ 28A	28	31.1	34.4	1	45.4	110	5	5PFG
5.0SMLJ 30A	30	33.3	36.8	1	48.4	103	5	5PFK
5.0SMLJ 33A	33	36.7	40.6	1	53.3	93.9	5	5PFM
5.0SMLJ 36A	36	40	44.2	1	58.1	86.1	5	5PFP
5.0SMLJ 40A	40	44.4	49.1	1	64.5	77.6	5	5PFR
5.0SMLJ 43A	43	47.8	52.8	1	69.4	72.1	5	5PFT
5.0SMLJ 45A	45	50	55.3	1	72.7	68.8	5	5PFV
5.0SMLJ 48A	48	53.3	58.9	1	77.4	64.7	5	5PFX
5.0SMLJ 51A	51	56.7	62.7	1	82.4	60.7	5	5PFZ
5.0SMLJ 54A	54	60	66.3	1	87.1	57.5	5	5RGE
5.0SMLJ 58A	58	64.4	71.2	1	93.6	53.5	5	5PGG
5.0SMLJ 60A	60	66.7	73.7	1	96.8	51.7	5	5PGK
5.0SMLJ 64A	64	71.1	78.6	1	103	48.6	5	5PGM
5.0SMLJ 70A	70	77.8	86	1	113	44.3	5	5PGP
5.0SMLJ 75A	75	83.3	92.1	1	121	41.4	5	5PGR
5.0SMLJ 78A	78	86.7	95.8	1	126	39.7	5	5PGT
5.0SMLJ 85A	85	94.4	104	1	137	36.5	5	5PGV
5.0SMLJ 90A	90	100	111	1	146	34.3	5	5PGX
5.0SMLJ 100A	100	111	123	1	162	30.9	5	5PGZ
5.0SMLJ 110A	110	122	135	1	177	28.3	5	5PHE
5.0SMLJ 120A	120	133	147	1	193	26	5	5PHG
5.0SMLJ 130A	130	144	159	1	209	24	5	5PHK
5.0SMLJ 150A	150	167	185	1	243	20.6	5	5PHM
5.0SMLJ 160A	160	178	197	1	259	19.3	5	5PHP
5.0SMLJ 170A	170	189	209	1	275	18.2	5	5PHR

# 5.0SMLJ11CA~5.0SMLJ170CA

PART NUMBER	REVERSE STAND- OFF VOLTAGE V <sub>RWM</sub> (V)	BREAKDOWN VOLTAGE V <sub>BR</sub> (V) MIN.@IT	BREAKDOWN VOLTAGE V <sub>BR</sub> (V) MAX.@IT	TEST CURRENT I <sub>T</sub> (mA)	MAXIMUM CLAMPING VOLTAGE	PEAK PULSE CURRENT I <sub>pp</sub> (A)	REVERSE LEAKAGE	DEVICE MARKING CODE
					@I <sub>pp</sub> V <sub>c</sub> (V)		@V <sub>RWM</sub> I <sub>D</sub> (μA)	
5.0SMLJ 11CA	11	12.2	13.5	10	18.2	275	800	5BEN
5.0SMLJ 12CA	12	13.3	14.7	10	19.9	252	800	5BEP
5.0SMLJ 13CA	13	14.4	15.9	10	21.5	233	500	5BEQ
5.0SMLJ 14CA	14	15.6	17.2	10	23.2	216	200	5BER
5.0SMLJ 15CA	15	16.7	18.5	1	24.4	205	100	5BES
5.0SMLJ 16CA	16	17.8	19.7	1	26	193	50	5BET
5.0SMLJ 17CA	17	18.9	20.9	1	27.6	181	20	5BEU
5.0SMLJ 18CA	18	20	22.1	1	29.2	172	10	5BEV
5.0SMLJ 20CA	20	22.2	24.5	1	32.4	155	5	5BEW
5.0SMLJ 22CA	22	24.4	26.9	1	35.5	141	5	5BEX
5.0SMLJ 24CA	24	26.7	29.5	1	38.9	129	5	5BEZ
5.0SMLJ 26CA	26	28.9	31.9	1	42.1	119	5	5BFE
5.0SMLJ 28CA	28	31.1	34.4	1	45.4	110	5	5BFG
5.0SMLJ 30CA	30	33.3	36.8	1	48.4	103	5	5BFK
5.0SMLJ 33CA	33	36.7	40.6	1	53.3	93.9	5	5BFM
5.0SMLJ 36CA	36	40	44.2	1	58.1	86.1	5	5BFP
5.0SMLJ 40CA	40	44.4	49.1	1	64.5	77.6	5	5BFR
5.0SMLJ 43CA	43	47.8	52.8	1	69.4	72.1	5	5BFT
5.0SMLJ 45CA	45	50	55.3	1	72.7	68.8	5	5BFV
5.0SMLJ 48CA	48	53.3	58.9	1	77.4	64.7	5	5BFX
5.0SMLJ 51CA	51	56.7	62.7	1	82.4	60.7	5	5BFZ
5.0SMLJ 54CA	54	60	66.3	1	87.1	57.5	5	5BGE
5.0SMLJ 58CA	58	64.4	71.2	1	93.6	53.5	5	5BGG
5.0SMLJ 60CA	60	66.7	73.7	1	96.8	51.7	5	5BGK
5.0SMLJ 64CA	64	71.1	78.6	1	103	48.6	5	5BGM
5.0SMLJ 70CA	70	77.8	86	1	113	44.3	5	5BGP
5.0SMLJ 75CA	75	83.3	92.1	1	121	41.4	5	5BGR
5.0SMLJ 78CA	78	86.7	95.8	1	126	39.7	5	5BGT
5.0SMLJ 85CA	85	94.4	104	1	137	36.5	5	5BGV
5.0SMLJ 90CA	90	100	111	1	146	34.3	5	5BGX
5.0SMLJ 100CA	100	111	123	1	162	30.9	5	5BGZ
5.0SMLJ 110CA	110	122	135	1	177	28.3	5	5BHE
5.0SMLJ 120CA	120	133	147	1	193	26	5	5BHG
5.0SMLJ 130CA	130	144	159	1	209	24	5	5BHK
5.0SMLJ 150CA	150	167	185	1	243	20.6	5	5BHM
5.0SMLJ 160CA	160	178	197	1	259	19.3	5	5BHP
5.0SMLJ 170CA	170	189	209	1	275	18.2	5	5BHR

For Bidirectional type having V<sub>rwm</sub> of 20 volts and less,the I<sub>r</sub> limit is double.

# 5.0SMLJ11CA~5.0SMLJ170CA

Ratings and Characteristic Curves ( $T_A=25^\circ\text{C}$  unless otherwise noted)

**Figure 1 - Peak Pulse Power Rating Curve**

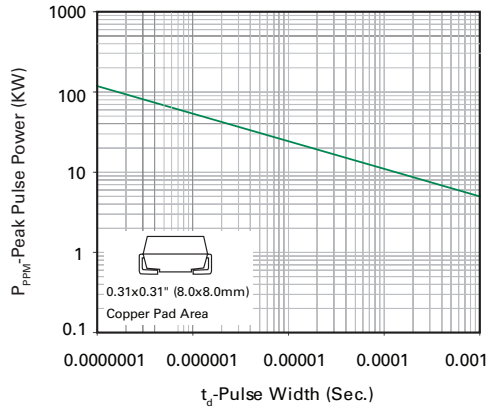

**Figure 2 - Peak Pulse Power or Current Derating Curve vs Initial Junction Temperature**

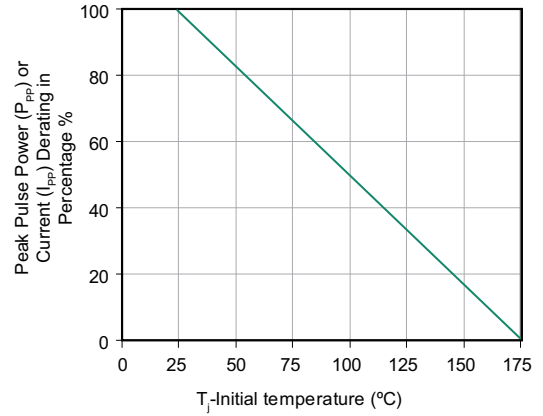

**Figure 3 - Pulse Waveform**

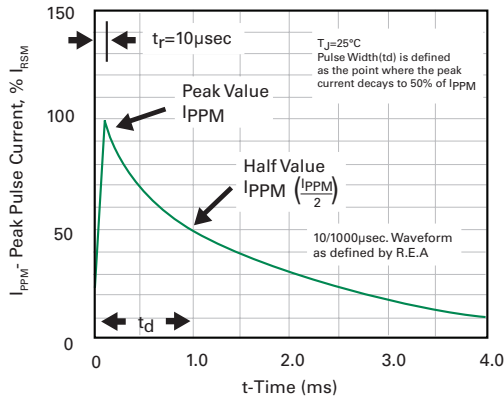

**Figure 4 - Typical Junction Capacitance**

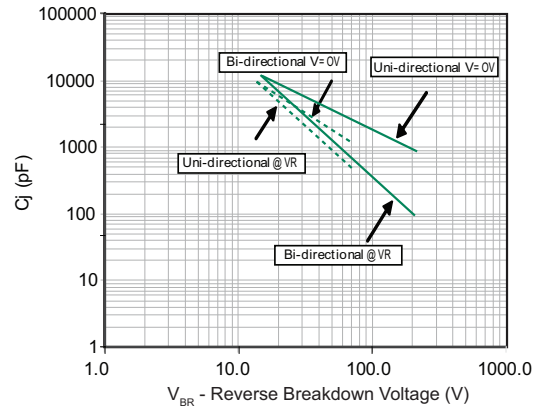

**Figure 5 - Steady State Power Derating Curve**

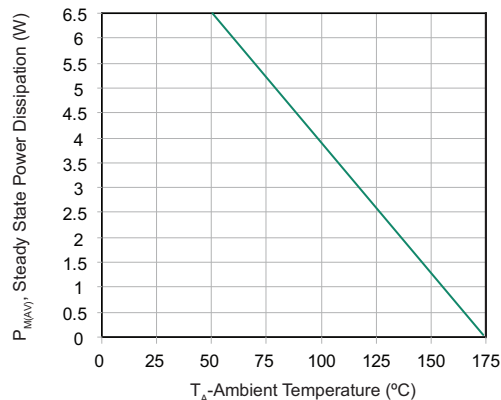

**Figure 6 - Maximum Non-Repetitive Peak Forward Surge Current Uni-Directional Only**

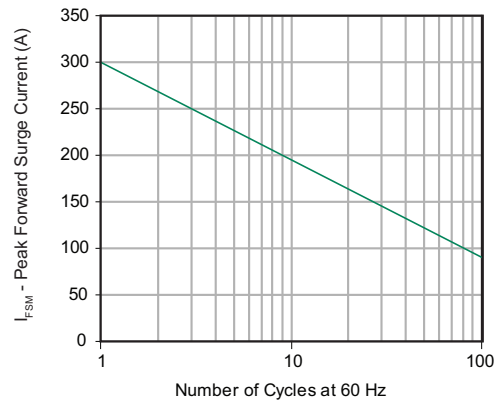



Micro Commercial Components

### Ordering Information :

Device	Packing
Part Number-TP	Tape&Reel: 3Kpcs/Reel

Note : Adding "-HF" suffix for halogen free, eg. Part Number-TP-HF

**\*\*\*IMPORTANT NOTICE\*\*\***

**Micro Commercial Components Corp.** reserves the right to make changes without further notice to any product herein to make corrections, modifications , enhancements , improvements , or other changes . **Micro Commercial Components Corp .** does not assume any liability arising out of the application or use of any product described herein; neither does it convey any license under its patent rights ,nor the rights of others . The user of products in such applications shall assume all risks of such use and will agree to hold **Micro Commercial Components Corp .** and all the companies whose products are represented on our website, harmless against all damages.

**\*\*\*LIFE SUPPORT\*\*\***

MCC's products are not authorized for use as critical components in life support devices or systems without the express written approval of Micro Commercial Components Corporation.

**\*\*\*CUSTOMER AWARENESS\*\*\***

Counterfeiting of semiconductor parts is a growing problem in the industry. Micro Commercial Components (MCC) is taking strong measures to protect ourselves and our customers from the proliferation of counterfeit parts. MCC strongly encourages customers to purchase MCC parts either directly from MCC or from Authorized MCC Distributors who are listed by country on our web page cited below. Products customers buy either from MCC directly or from Authorized MCC Distributors are genuine parts, have full traceability, meet MCC's quality standards for handling and storage. **MCC will not provide any warranty coverage or other assistance for parts bought from Unauthorized Sources.** MCC is committed to combat this global problem and encourage our customers to do their part in stopping this practice by buying direct or from authorized distributors.

**[www.mccsemi.com](http://www.mccsemi.com)**