



Micro Commercial Components



Micro Commercial Components
20736 Marilla Street Chatsworth
CA 91311
Phone: (818) 701-4933
Fax: (818) 701-4939

FR151S THRU FR157S

1.5 Amp Fast Recovery Rectifier 50 to 1000 Volts

Features

- Halogen free available upon request by adding suffix "-HF"
- Epoxy meets UL 94 V-0 flammability rating
- Moisture Sensitivity Level 1
- Fast Switching Speed For High Efficiency
- High Current Capability
- Lead Free Finish/RoHS Compliant (Note1) ("P" Suffix designates Compliant. See ordering information)

Maximum Ratings

- Operating Temperature: -55°C to +150°C
- Storage Temperature: -55°C to +150°C

MCC Catalog Number	Device Marking	Maximum Recurrent Peak Reverse Voltage	Maximum RMS Voltage	Maximum DC Blocking Voltage
FR151S	FR151S	50V	35V	50V
FR152S	FR152S	100V	70V	100V
FR153S	FR153S	200V	140V	200V
FR154S	FR154S	400V	280V	400V
FR155S	FR155S	600V	420V	600V
FR156S	FR156S	800V	560V	800V
FR157S	FR157S	1000V	700V	1000V

Electrical Characteristics @ 25°C Unless Otherwise Specified

Average Forward Current	$I_{F(AV)}$	1.5 A	$T_A = 55^\circ\text{C}$
Peak Forward Surge Current	I_{FSM}	50A	8.3ms, half sine
Maximum Instantaneous Forward Voltage	V_F	1.3V	$I_{FM} = 1.5\text{A};$ $T_A = 25^\circ\text{C}$
Maximum DC Reverse Current At Rated DC Blocking Voltage	I_R	5.0 μA 100 μA	$T_A = 25^\circ\text{C}$ $T_A = 100^\circ\text{C}$
Maximum Reverse Recovery Time FR151S-154S FR155S FR156S-157S	T_{rr}	150ns 250ns 500ns	$I_F=0.5\text{A}, I_R=1.0\text{A},$ $I_{rr}=0.25\text{A}$
Typical Junction Capacitance	C_J	20pF	Measured at 1.0MHz, $V_R=4.0\text{V}$

DO-41

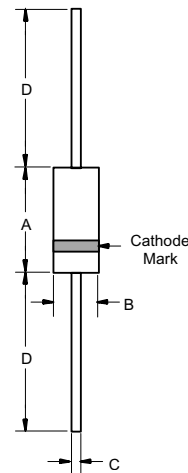

DIM	DIMENSIONS				NOTE
	INCHES		MM		
A	.166	.205	4.10	5.20	
B	.080	.107	2.00	2.70	
C	.028	.034	.70	.90	
D	1.000	---	25.40	---	

*Pulse Test: Pulse Width 300 μsec , Duty Cycle 1%

Note: 1. High Temperature Solder Exemption Applied, see EU Directive Annex 7.

www.mccsemi.com

FR151S thru FR157S

Figure 1
 Typical Forward Characteristics

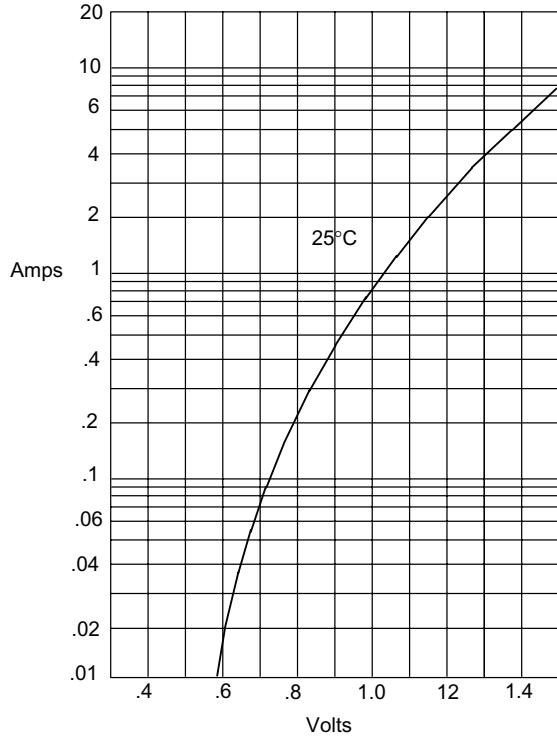

Instantaneous Forward Current - Amperes versus
 Instantaneous Forward Voltage - Volts

Figure 2
 Forward Derating Curve

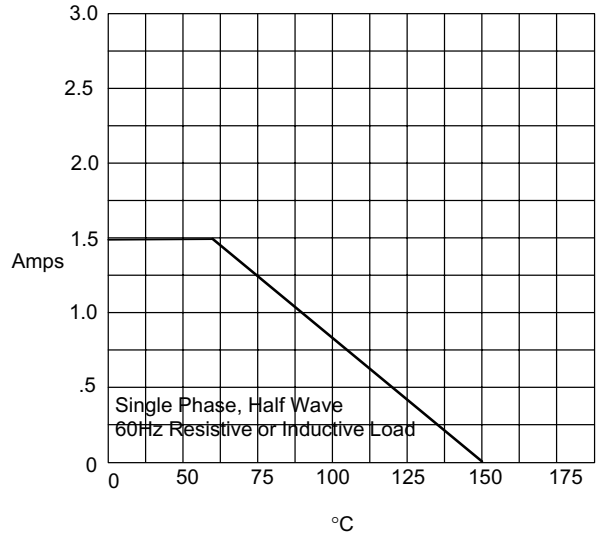

Average Forward Rectified Current - Amperes versus
 Ambient Temperature - °C

Figure 3
 Junction Capacitance

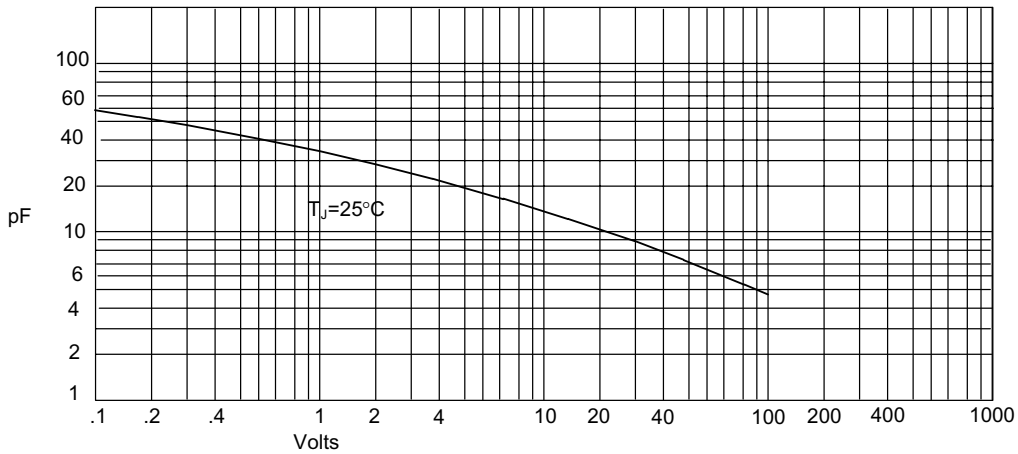

Junction Capacitance - pF versus
 Reverse Voltage - Volts

Figure 4
 Maximum Non-Repetitive Forward Surge Current

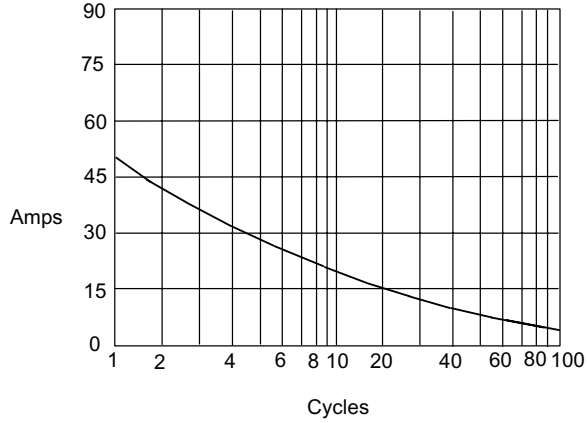

Peak Forward Surge Current - Amperes versus
 Number Of Cycles At 60Hz - Cycles

Figure 5
 Reverse Recovery Time Characteristic And Test Circuit Diagram

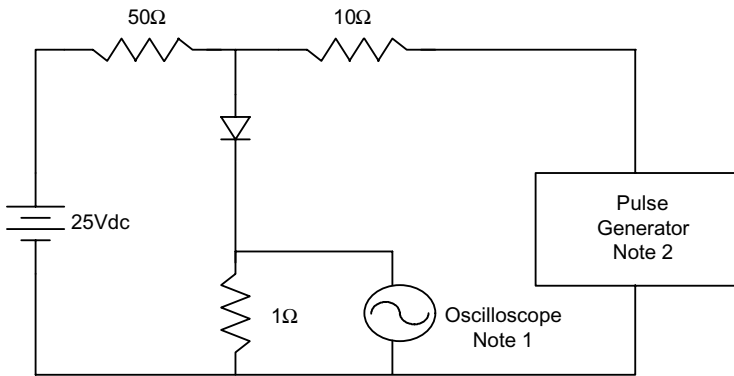

- Notes:
1. Rise Time = 7ns max.
 Input impedance = 1 megohm, 22pF
 2. Rise Time = 10ns max.
 Source impedance = 50 ohms
 3. Resistors are non-inductive

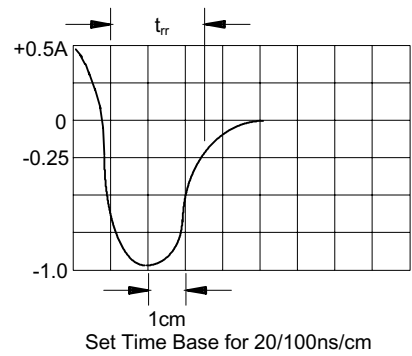



Micro Commercial Components

Ordering Information :

Device	Packing
Part Number-TP	Tape&Reel: 5Kpcs/Reel
Part Number-AP	Ammo Packing: 5Kpcs/Ammo Box
Part Number-BP	Bulk: 50Kpcs/Carton

Note : Adding "-HF" suffix for halogen free, eg. Part Number-TP-HF

IMPORTANT NOTICE

Micro Commercial Components Corp. reserves the right to make changes without further notice to any product herein to make corrections, modifications , enhancements , improvements , or other changes . **Micro Commercial Components Corp .** does not assume any liability arising out of the application or use of any product described herein; neither does it convey any license under its patent rights ,nor the rights of others . The user of products in such applications shall assume all risks of such use and will agree to hold **Micro Commercial Components Corp .** and all the companies whose products are represented on our website, harmless against all damages.

LIFE SUPPORT

MCC's products are not authorized for use as critical components in life support devices or systems without the express written approval of Micro Commercial Components Corporation.

CUSTOMER AWARENESS

Counterfeiting of semiconductor parts is a growing problem in the industry. Micro Commercial Components (MCC) is taking strong measures to protect ourselves and our customers from the proliferation of counterfeit parts. MCC strongly encourages customers to purchase MCC parts either directly from MCC or from Authorized MCC Distributors who are listed by country on our web page cited below. Products customers buy either from MCC directly or from Authorized MCC Distributors are genuine parts, have full traceability, meet MCC's quality standards for handling and storage. **MCC will not provide any warranty coverage or other assistance for parts bought from Unauthorized Sources.** MCC is committed to combat this global problem and encourage our customers to do their part in stopping this practice by buying direct or from authorized distributors.

www.mccsemi.com