



Micro Commercial Components



Micro Commercial Components  
 20736 Marilla Street Chatsworth  
 CA 91311  
 Phone: (818) 701-4933  
 Fax: (818) 701-4939

# ES1AE THRU ES1ME

## Features

- Lead Free Finish/Rohs Compliant (Note1) ("P" Suffix designates Compliant. See ordering information)
- Epoxy meets UL 94 V-0 flammability rating
- Moisture Sensitivity Level 1
- High Temp Soldering: 260°C for 10 Seconds At Terminals
- Superfast Recovery Times For High Efficiency

## Maximum Ratings

- Operating Temperature: -50°C to +150°C
- Storage Temperature: -50°C to +150°C
- Maximum Thermal Resistance; 15°C/W Junction To Lead

MCC Part Number	Device Marking	Maximum Recurrent Peak Reverse Voltage	Maximum RMS Voltage	Maximum DC Blocking Voltage
ES1AE	ES1A	50V	35V	50V
ES1BE	ES1B	100V	70V	100V
ES1CE	ES1C	150V	105V	150V
ES1DE	ES1D	200V	140V	200V
ES1GE	ES1G	400V	280V	400V
ES1JE	ES1J	600V	420V	600V
ES1KE	ES1K	800V	560V	800V
ES1ME	ES1M	1000V	700V	1000V

## Electrical Characteristics @ 25°C Unless Otherwise Specified

Average Forward Current	$I_{F(AV)}$	1.0A	$T_J = 75^\circ\text{C}$
Peak Forward Surge Current	$I_{FSM}$	30A	8.3ms, half sine
Maximum Instantaneous Forward Voltage	$V_F$	ES1AE-DE .975V ES1GE-JE 1.35V ES1KE~ME 1.70V	$I_{FM} = 1.0A$ ; $T_J = 25^\circ\text{C}^*$
Maximum DC Reverse Current At Rated DC Blocking Voltage	$I_R$	5 $\mu\text{A}$ 100 $\mu\text{A}$	$T_J = 25^\circ\text{C}$ $T_J = 100^\circ\text{C}$
Maximum Reverse Recovery Time	$T_{rr}$	ES1AE-DE 50ns ES1GE-KE 75ns ES1ME 100ns	$I_F = 0.5A$ , $I_R = 1.0A$ , $I_{rr} = 0.25A$
Typical Junction Capacitance	$C_J$	45pF	Measured at 1.0MHz, $V_R = 4.0V$

\*Pulse test: Pulse width 200  $\mu\text{sec}$ , Duty cycle 2%

Note: 1. High Temperature Solder Exemptions Applied, see EU Directive Annex 7.

## 1 Amp Ultra Fast Recovery Silicon Rectifier 50 to 1000 Volts

### DO-214AC (SMAE)

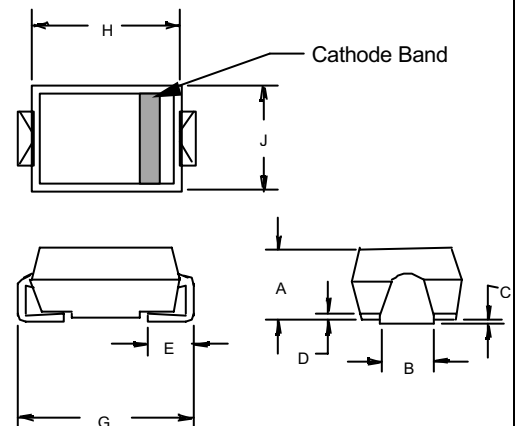

DIM	DIMENSIONS				NOTE
	INCHES		MM		
A	.079	.096	2.01	2.44	
B	.050	.075	1.27	1.90	
C	.002	.008	.05	.20	
D	—	.02	—	.51	
E	.030	.060	.76	1.52	
G	.189	.208	4.80	5.30	
H	.157	.180	4.00	4.57	
J	.090	.115	2.29	2.92	

### SUGGESTED SOLDER PAD LAYOUT

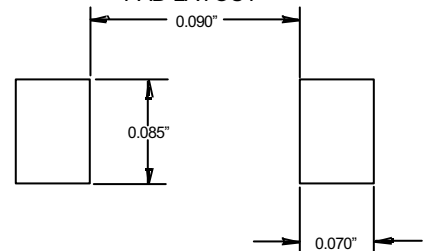

# ES1AE thru ES1ME

Figure 1  
Typical Forward Characteristics

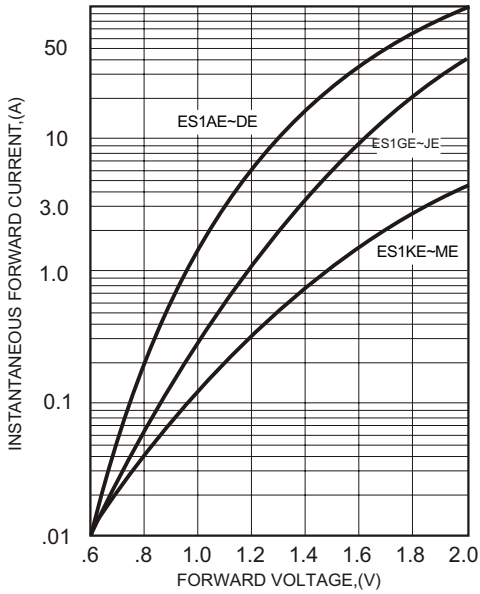

Instantaneous Forward Current - Amperes *versus*  
Instantaneous Forward Voltage - Volts

Figure 2  
Forward Derating Curve

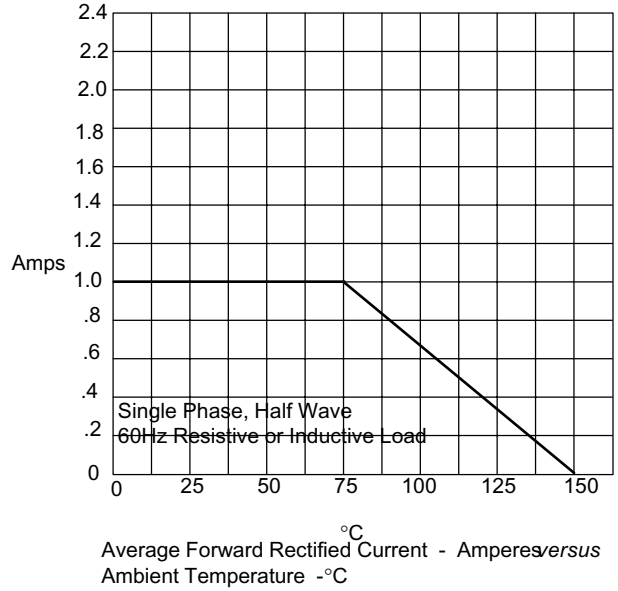
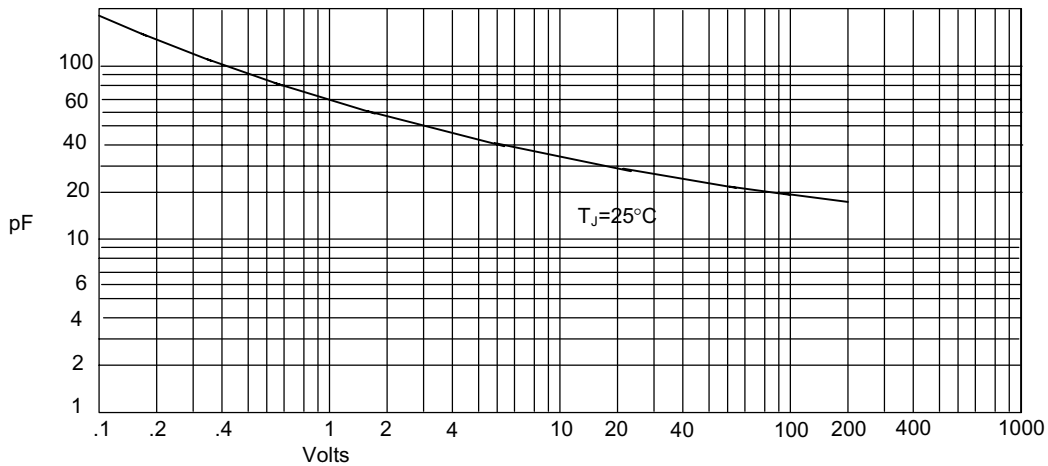
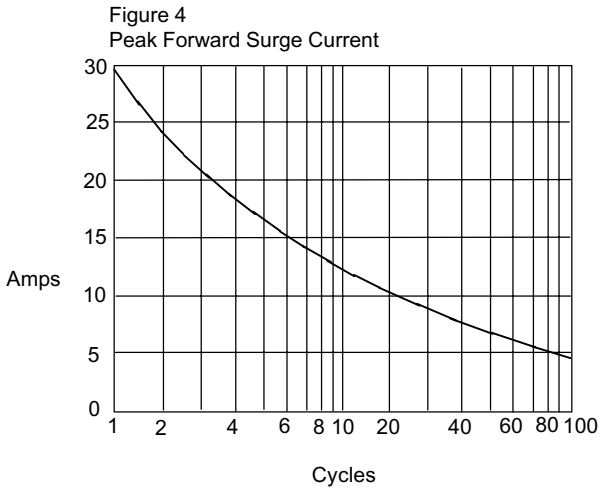

Figure 3  
Junction Capacitance



Junction Capacitance - pF *versus*  
Reverse Voltage - Volts

# ES1AE thru ES1ME



Peak Forward Surge Current - Amperes versus  
 Number Of Cycles At 60Hz - Cycles

Figure 6  
 Reverse Recovery Time Characteristic And Test Circuit Diagram

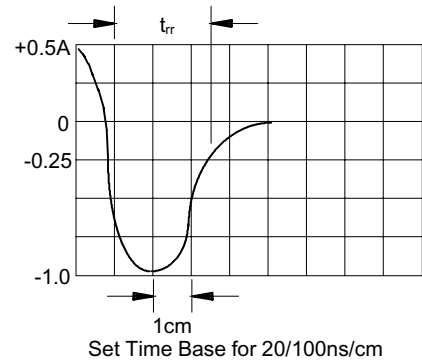
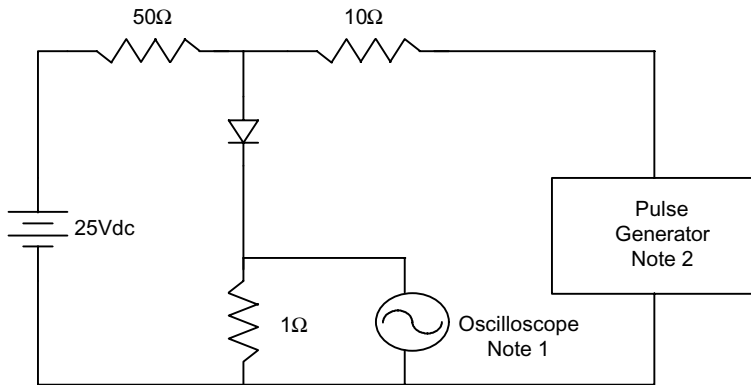

Notes:

1. Rise Time = 7ns max.  
 Input impedance = 1 megohm, 22pF
2. Rise Time = 10ns max.  
 Source impedance = 50 ohms
3. Resistors are non-inductive



Micro Commercial Components

Ordering Information :

Device	Packing
Part Number-TP	Tape&Reel: 6Kpcs/Reel

**\*\*\*IMPORTANT NOTICE\*\*\***

**Micro Commercial Components Corp.** reserves the right to make changes without further notice to any product herein to make corrections, modifications , enhancements , improvements , or other changes . **Micro Commercial Components Corp .** does not assume any liability arising out of the application or use of any product described herein; neither does it convey any license under its patent rights ,nor the rights of others . The user of products in such applications shall assume all risks of such use and will agree to hold **Micro Commercial Components Corp .** and all the companies whose products are represented on our website, harmless against all damages.

**\*\*\*LIFE SUPPORT\*\*\***

MCC's products are not authorized for use as critical components in life support devices or systems without the express written approval of Micro Commercial Components Corporation.

**\*\*\*CUSTOMER AWARENESS\*\*\***

Counterfeiting of semiconductor parts is a growing problem in the industry. Micro Commercial Components (MCC) is taking strong measures to protect ourselves and our customers from the proliferation of counterfeit parts. MCC strongly encourages customers to purchase MCC parts either directly from MCC or from Authorized MCC Distributors who are listed by country on our web page cited below. Products customers buy either from MCC directly or from Authorized MCC Distributors are genuine parts, have full traceability, meet MCC's quality standards for handling and storage. **MCC will not provide any warranty coverage or other assistance for parts bought from Unauthorized Sources.** MCC is committed to combat this global problem and encourage our customers to do their part in stopping this practice by buying direct or from authorized distributors.

[www.mccsemi.com](http://www.mccsemi.com)