



Micro Commercial Components



Micro Commercial Components  
20736 Marilla Street Chatsworth  
CA 91311  
Phone: (818) 701-4933  
Fax: (818) 701-4939

# MC78M05ACDT

## Features

- Output current in excess of 0.5 Ampere
- Internal thermal overload protection
- Internal short-circuit current limiting
- High power dissipation capability
- Epoxy meets UL 94 V-0 flammability rating
- Moisture Sensitivity Level 1

## Maximum Ratings @ T<sub>a</sub>=25°C, Unless Otherwise Noted

Parameter	Symbol	Value	Unit
Input Voltage	V <sub>i</sub>	35	V
Power Dissipation	P <sub>D</sub>	1.25	W
Operating Junction Temperature	T <sub>OPR</sub>	0 ---+125	°C
Storage Temperature Range	T <sub>STG</sub>	-65---+150	°C

## Electrical Characteristics (V<sub>i</sub>=10V, I<sub>o</sub>=350mA, 0°C<T<sub>j</sub><125°C, C<sub>i</sub>=0.33µF, C<sub>o</sub>=0.1µF, Unless Otherwise Specified)

Parameter	Sym	Min	Typ	Max	Test conditions
Output Voltage	V <sub>o</sub>	4.9V	5.0V	5.1V	T <sub>J</sub> =25°C
		4.85V	5.0V	5.15V	7V ≤ V <sub>i</sub> ≤ 20V, 5mA ≤ I <sub>o</sub> ≤ 350mA, P <sub>D</sub> =15W
Load Regulation	ΔV <sub>o</sub>		15mV	100mV	5mA ≤ I <sub>o</sub> ≤ 0.5A, T <sub>J</sub> =25°C
			5.0mV	50mV	5mA ≤ I <sub>o</sub> ≤ 200mA, T <sub>J</sub> =25°C
Line regulation	ΔV <sub>o</sub>		3.0mV	100mV	7V ≤ V <sub>i</sub> ≤ 25V, I <sub>o</sub> =0.2A
			1.0mV	50mV	8V ≤ V <sub>i</sub> ≤ 25V, I <sub>o</sub> =0.2A
Quiescent Current	I <sub>q</sub>		4.2mA	6.0mA	T <sub>J</sub> =25°C
Quiescent Current Change	ΔI <sub>q</sub>			0.8mA	8V ≤ V <sub>i</sub> ≤ 25V, I <sub>o</sub> =0.2A
				0.5mA	5mA ≤ I <sub>o</sub> ≤ 350mA
Output Noise Voltage	V <sub>N</sub>		40µV	200µV	10Hz ≤ f ≤ 120Hz
Ripple Rejection	RR	62dB	80dB		8V ≤ V <sub>i</sub> ≤ 18V f=120Hz, I <sub>o</sub> =0.3A T <sub>J</sub> =25°C
Dropout Voltage	V <sub>d</sub>		2.0V	2.5V	I <sub>o</sub> =0.35A, T <sub>J</sub> =25°C
Output Short Circuit Current	I <sub>sc</sub>		300mA		V <sub>i</sub> =10V, T <sub>J</sub> =25°C
Peak Output Current	I <sub>pk</sub>		0.7A		T <sub>J</sub> =25°C

## TYPICAL APPLICATION

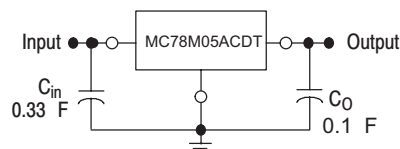

## Three-Terminal Positive Voltage Regulators

### DPAK

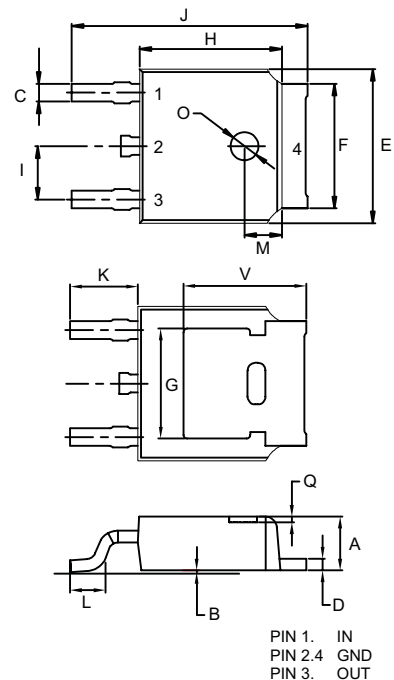

DIM	DIMENSIONS				NOTE
	INCHES		MM		
	MIN	MAX	MIN	MAX	
A	0.087	0.094	2.20	2.40	
B	0.000	0.005	0.00	0.13	
C	0.026	0.034	0.66	0.86	
D	0.018	0.023	0.46	0.58	
E	0.256	0.264	6.50	6.70	
F	0.201	0.215	5.10	5.46	
G	0.190		4.83		
H	0.236	0.244	6.00	6.20	
I	0.086	0.094	2.18	2.39	
J	0.386	0.409	9.80	10.40	
K	0.114		2.90		
L	0.055	0.067	1.40	1.70	
M	0.063		1.60		
O	0.043	0.051	1.10	1.30	
Q	0.000	0.012	0.00	0.30	
V	0.211		5.35		

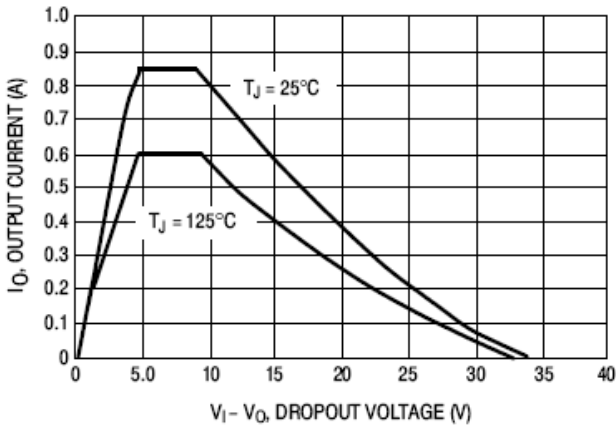

Figure 1. Peak Output Current versus Dropout Voltage

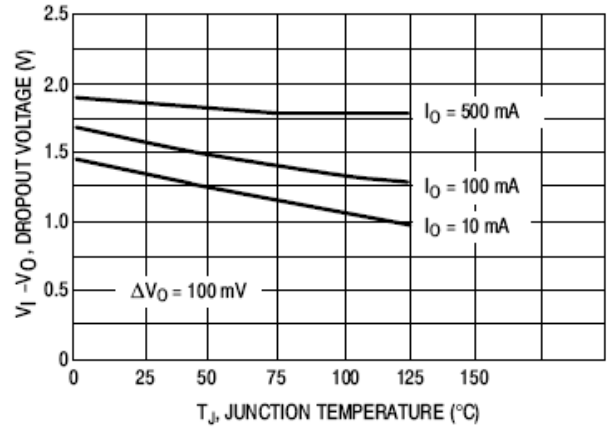

Figure 2. Dropout Voltage versus Junction Temperature

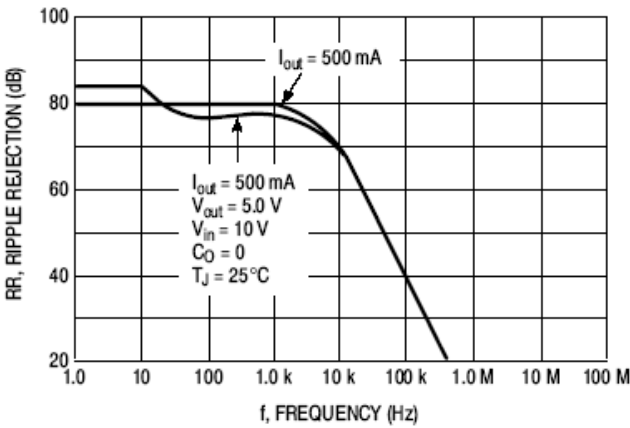

Figure 3. Ripple Rejection versus Frequency

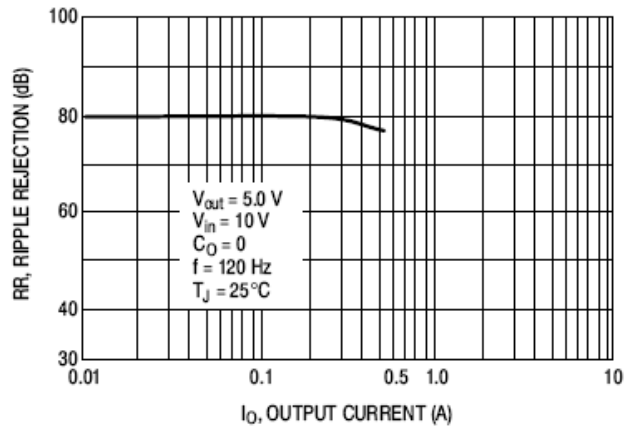

Figure 4. Ripple Rejection versus Output Current

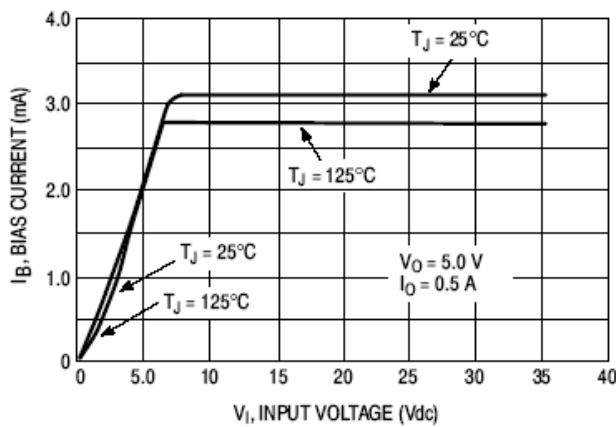

Figure 5. Bias Current versus Input Voltage

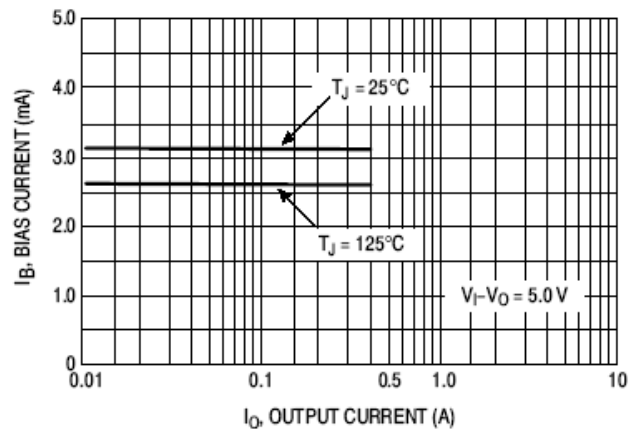

Figure 6. Bias Current versus Output Current



Micro Commercial Components

Ordering Information :

Device	Packing
Part Number-TP	Tape&Reel: 2.5Kpcs/Reel

**\*\*\*IMPORTANT NOTICE\*\*\***

**Micro Commercial Components Corp.** reserves the right to make changes without further notice to any product herein to make corrections, modifications , enhancements , improvements , or other changes . **Micro Commercial Components Corp .** does not assume any liability arising out of the application or use of any product described herein; neither does it convey any license under its patent rights ,nor the rights of others . The user of products in such applications shall assume all risks of such use and will agree to hold **Micro Commercial Components Corp .** and all the companies whose products are represented on our website, harmless against all damages.

**\*\*\*LIFE SUPPORT\*\*\***

MCC's products are not authorized for use as critical components in life support devices or systems without the express written approval of Micro Commercial Components Corporation.

**\*\*\*CUSTOMER AWARENESS\*\*\***

Counterfeiting of semiconductor parts is a growing problem in the industry. Micro Commercial Components (MCC) is taking strong measures to protect ourselves and our customers from the proliferation of counterfeit parts. MCC strongly encourages customers to purchase MCC parts either directly from MCC or from Authorized MCC Distributors who are listed by country on our web page cited below. Products customers buy either from MCC directly or from Authorized MCC Distributors are genuine parts, have full traceability, meet MCC's quality standards for handling and storage. **MCC will not provide any warranty coverage or other assistance for parts bought from Unauthorized Sources.** MCC is committed to combat this global problem and encourage our customers to do their part in stopping this practice by buying direct or from authorized distributors.