

Capacitive sensor BC20-CP40-VP4X2-H1141

TURCK

Industrial
Automation

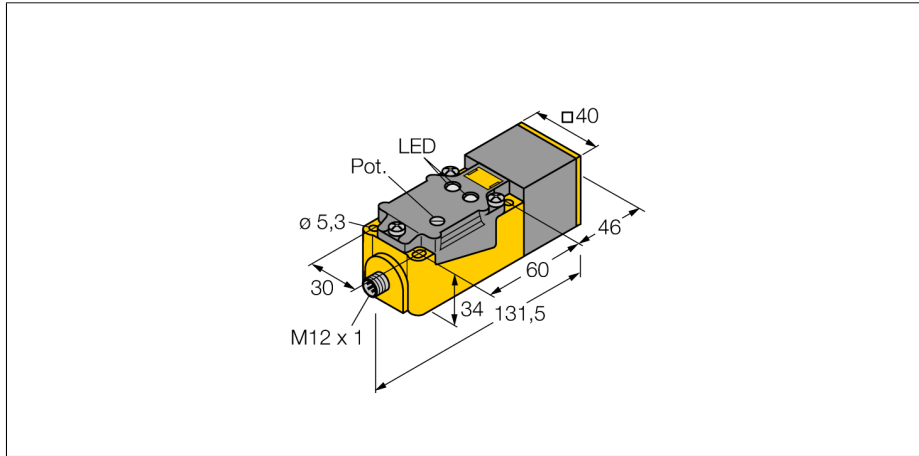

- Rectangular, height 40 mm
- 9 selectable sensor head positions
- Plastic, PBT-GF30-V0
- Fine adjustment via potentiometer
- DC 4-wire, 10...65 VDC
- Changeover contact, PNP output
- M12 x 1 connector

Wiring diagram

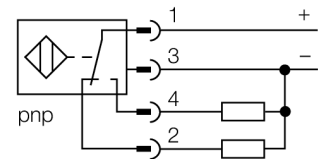

Functional principle

Capacitive proximity switches are designed for non-contact and wear-free detection of electrically conductive as well as non-conductive metal objects.

Type code	BC20-CP40-VP4X2-H1141
Ident no.	2516102
Rated operating distance Sn	20 mm
Rated operating distance Sn	20 mm, non-flush mounting
Assured sensing range	≤ (0.72 x Sn) mm
Hysteresis	2...20 %
Temperaturdrift	type ≤ ± 20 %
Repeatability	≤ 2 % of full scale
Ambient temperature	-25...+70 °C
Operating voltage	10...65VDC
Residual ripple	≤ 10 % U _{is}
DC rated operational current	≤ 200 mA
No-load current I ₀	≤ 15 mA
Residual current	≤ 0.1 mA
Switching frequency	0.1 kHz
Rated insulation voltage	≤ 0.5 kV
Output function	4-wire, changover contact, PNP
Short-circuit protection	yes/ cyclic
Voltage drop at I ₀	≤ 1.8 V
Wire breakage / Reverse polarity protection	yes/ complete
Design	rectangular, CP40
Dimensions	114x 40x 40 mm
Housing material	Plastic, PBT
Material active face	Plastic, PBT, yellow
Connection	male, M12 x 1
Vibration resistance	55 Hz (1 mm)
Shock resistance	30 g (11 ms)
Protection class	IP67
MTTF	1080 years acc. to SN 29500 (Ed. 99) 40 °C
Operating voltage	LED green
Switching state	● yellow
Diameter of the active area B	Ø 40 mm

Capacitive sensor
BC20-CP40-VP4X2-H1141

Accessories

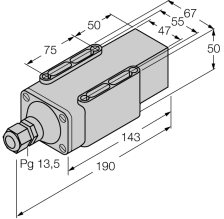
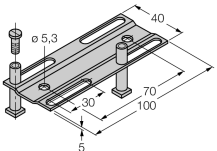
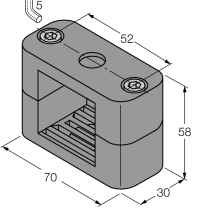
Type code	Ident no.	Description	Dimension drawing
SG40	69500	Protective housing; housing material: PA (per UL94/V-2); cover: PBT-GF30; for harsh environments; protection degree IP68, 5 m w.g.	
Adjusting bar JS 025/037	69429	Adjusting bar for rectangular housings CK/CP40; material: VA 1.4301	
BSS-CP40	6901318	Mounting bracket for rectangular devices; material: Polypropylene	

Wiring accessories

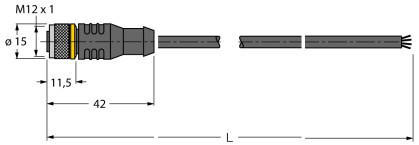
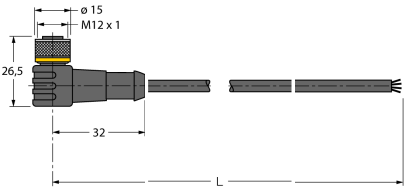
Type code	Ident no.	Description	Dimension drawing
RKC4.4T-2/TXL	6625503	Connection cable, female M12, straight, 4-pin, cable length: 2 m, sheath material: PVC, black; cULus approval; other cable lengths and qualities available, see www.turck.com	
WKC4.4T-2/TXL	6625515	Connection cable, female M12, angled, 4-pin, cable length: 2 m, sheath material: PVC, black; cULus approval; other cable lengths and qualities available, see www.turck.com	

Capacitive sensor
BC20-CP40-VP4X2-H1141

Wiring accessories

Type code	Ident no.	Description	Dimension drawing
RKC4.4T-2/TEL	6625013	Connection cable, female M12, straight, 4-pin, cable length: 2 m, sheath material: PVC, black; cULus approval; other cable lengths and qualities available, see www.turck.com	
WKC4.4T-2/TEL	6625025	Connection cable, female M12, angled, 4-pin, cable length: 2 m, sheath material: PVC, black; cULus approval; other cable lengths and qualities available, see www.turck.com	