

Inductive sensor
NI3-EG08K-AN6X-H1341

- Threaded barrel, M8 x 1
- Stainless steel, 1.4404
- DC 3-wire, 10...30 VDC
- NO contact, NPN output
- M12 x 1 connector

Wiring diagram

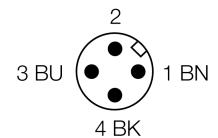
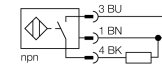

Functional principle

Inductive sensors detect metal objects contactless and wear-free. For this purpose they use a high-frequency electromagnetic AC field that interacts with the target. The sensors hosting a ferrite core coil generate the AC field through an LC resonant circuit.

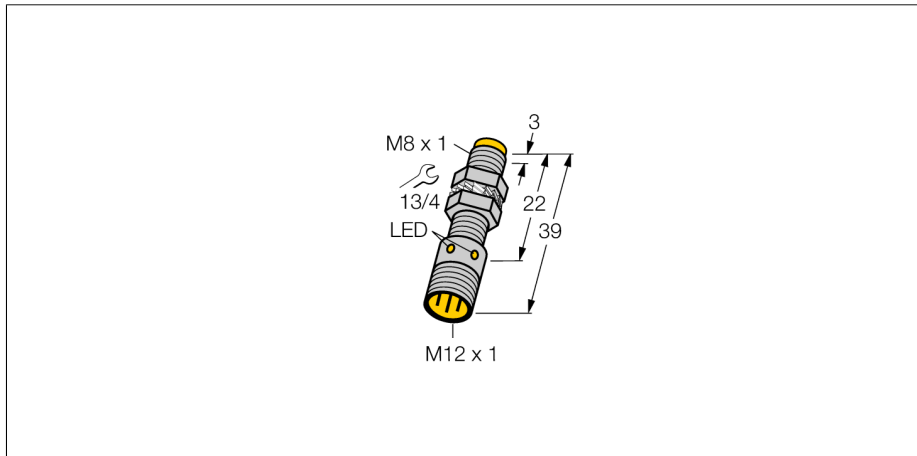

Type code	NI3-EG08K-AN6X-H1341
Ident no.	4669760
Rated operating distance Sn	3 mm
Mounting condition	non-flush
Assured sensing range	≤ (0,81 x Sn) mm
Correction factors	St37 = 1; Al = 0.3; stainless steel = 0.7; Ms = 0.4
Repeatability	≤ 2 % of full scale
Temperaturdrift	10 %
Hysteresis	3...15 %
Ambient temperature	-25...+70 °C
Operating voltage	10...30VDC
Residual ripple	≤ 10 % U _{ss}
DC rated operational current	≤ 150 mA
No-load current I ₀	≤ 15 mA
Residual current	≤ 0.1 mA
Rated insulation voltage	≤ 0.5 kV
Short-circuit protection	yes/ cyclic
Voltage drop at I ₀	≤ 1.8 V
Wire breakage / Reverse polarity protection	yes/ complete
Output function	3-wire, NO contact, NPN
Switching frequency	3 kHz
Design	threaded barrel, M8 x 1
Dimensions	39 mm
Housing material	Metal, V4A (1.4404)
Material active face	Plastic, PA
Max. tightening torque housing nut	10 Nm
Connection	male, M12 x 1
Vibration resistance	55 Hz (1 mm)
Shock resistance	30 g (11 ms)
Protection class	IP67
MTTF	2283 years acc. to SN 29500 (Ed. 99) 40 °C
Switching state	• yellow

Inductive sensor
NI3-EG08K-AN6X-H1341

Distance D	3 x B
Distance W	3 x Sn
Distance T	3 x B
Distance S	1.5 x B
Distance G	6 x Sn
Distance N	2 x Sn
<hr/>	
Diameter of the active area B	Ø 8 mm

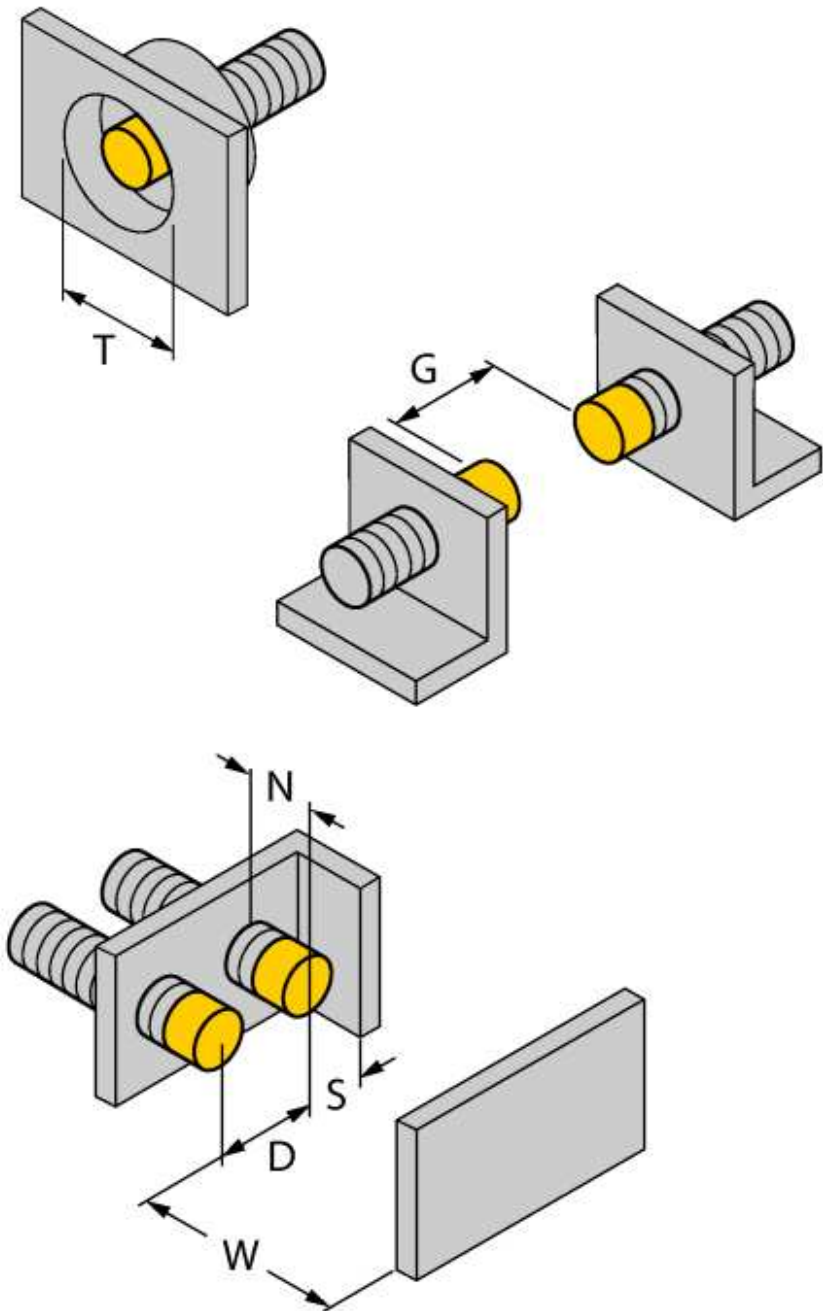

**Inductive sensor
NI3-EG08K-AN6X-H1341**

TURCK

Industrial
Automation

Accessories

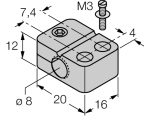
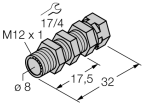
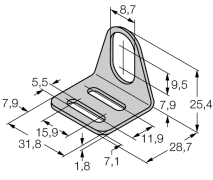
Type code	Ident no.	Description	Dimension drawing
BST-08B	6947210	Fixing clamp for threaded barrel devices, with dead-stop; material: PA6	
QM-08	6945100	Quick-mount bracket with dead-stop, chrome-plated brass, male thread M12 x 1. Note: The switching distance of proximity switches may be reduced through the use of quick-mount brackets.	
MW-08	6945008	Mounting bracket for threaded barrel devices; material: Stainless steel A2 1.4301 (AISI 304)	
BSS-08	6901322	Mounting bracket for smooth and threaded barrel devices; material: Polypropylene	