

- Threaded barrel, M18 x 1
- Chrome-plated brass
- Factor 1 for all metals
- Protection class IP68
- Magnetic field immune
- High switching distance
- Recessed mounting possible
- DC 3-wire, 10...30 VDC
- NO contact, PNP output
- M12 x 1 connector

Wiring diagram

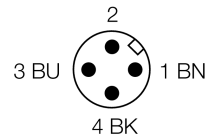
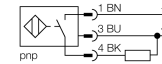

Functional principle

Inductive sensors detect metal objects contactless and wear-free. Due to the patented multi-coil system, *Uprox*®+ sensors have distinct advantages compared to conventional sensors. They excel in highest switching distances, maximum flexibility and operational reliability as well as efficient standardization.

Type code	BI8U-M18-AP6X-H1141
Ident no.	1644731
Rated operating distance Sn	8 mm
Mounting condition	flush
Assured sensing range	≤ (0,81 x Sn) mm
Repeatability	≤ 2 % of full scale
Temperaturdrift	10 %
	≤ ± 15 %, ≤ -25 °C v ≥ +70 °C
Hysteresis	3...15 %
Ambient temperature	-30...+85 °C
Operating voltage	10...30VDC
Residual ripple	≤ 10 % U _{ss}
DC rated operational current	≤ 200 mA
No-load current I ₀	≤ 15 mA
Residual current	≤ 0.1 mA
Rated insulation voltage	≤ 0.5 kV
Short-circuit protection	yes/ cyclic
Voltage drop at I _e	≤ 1.8 V
Wire breakage / Reverse polarity protection	yes/ complete
Output function	3-wire, NO contact, PNP
Protection class	☐
Switching frequency	1.5 kHz
Design	threaded barrel, M18 x 1
Dimensions	52 mm
Housing material	Metal, CuZn, chrome-plated
Material active face	Plastic, LCP
Max. tightening torque housing nut	25 Nm
Connection	male, M12 x 1
Vibration resistance	55 Hz (1 mm)
Shock resistance	30 g (11 ms)
Protection class	IP68
MTTF	874 years acc. to SN 29500 (Ed. 99) 40 °C
Switching state	• yellow

Distance D	36 mm
Distance W	24 mm
Distance T	54 mm
Distance S	27 mm
Distance G	48 mm

Diameter of the active area B \varnothing 18 mm

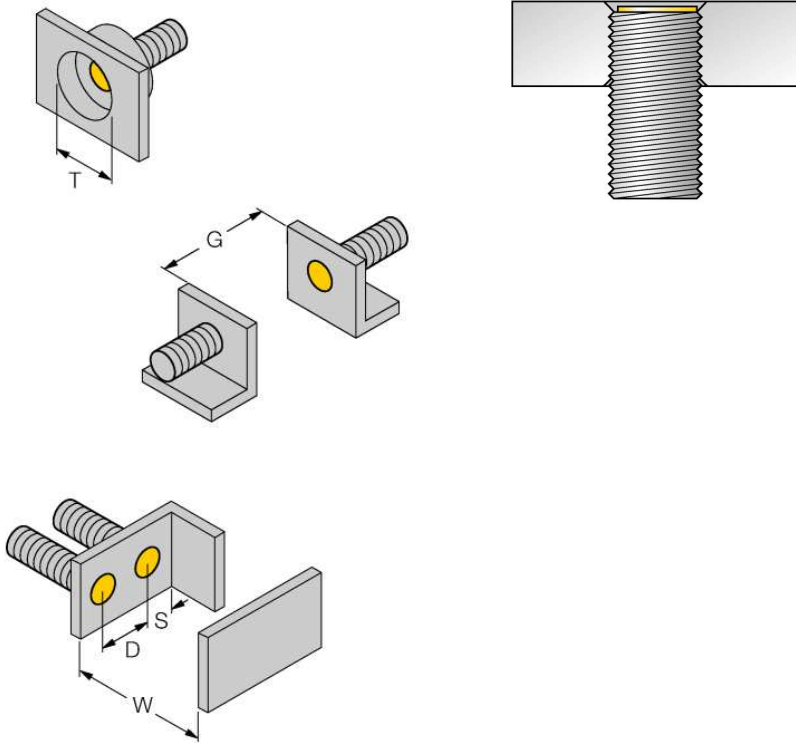

Flush and recessed mounting of all *uprox[®]+* threaded barrel sensors. Safe operation is ensured if the sensor is screwed in by half a turn.

Accessories

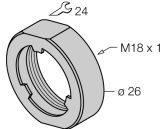
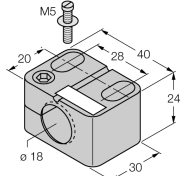
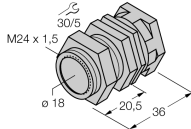
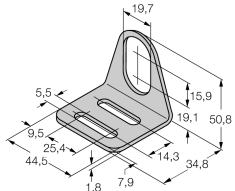
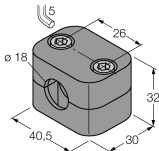
Type code	Ident no.	Description	Dimension drawing
PN-M18	6905310	Protective nut for M18 x 1 threaded barrels; material: Stainless steel A2 1.4305 (AISI 303)	
BST-18B	6947214	Fixing clamp for threaded barrel devices, with dead-stop; material: PA6	
QM-18	6945102	Quick-mount bracket with dead-stop; material: Chrome-plated brass Male thread M24 x 1.5. Note: The switching distance of proximity switches can be reduced by the use of quick-mount brackets.	
MW-18	6945004	Mounting bracket for threaded barrel devices; material: Stainless steel A2 1.4301 (AISI 304)	
BSS-18	6901320	Mounting bracket for smooth and threaded barrel devices; material: Polypropylene	

Wiring accessories

Type code	Ident no.	Description	Dimension drawing
RKC4T-2/TEL	6625010	Connection cable, female M12, straight, 3-pin, cable length: 2 m, sheath material: PVC, black; cULus approval; other cable lengths and qualities available, see www.turck.com	