

**Temperature measurement  
Probe  
TP-203A-CF-H1141-L100**

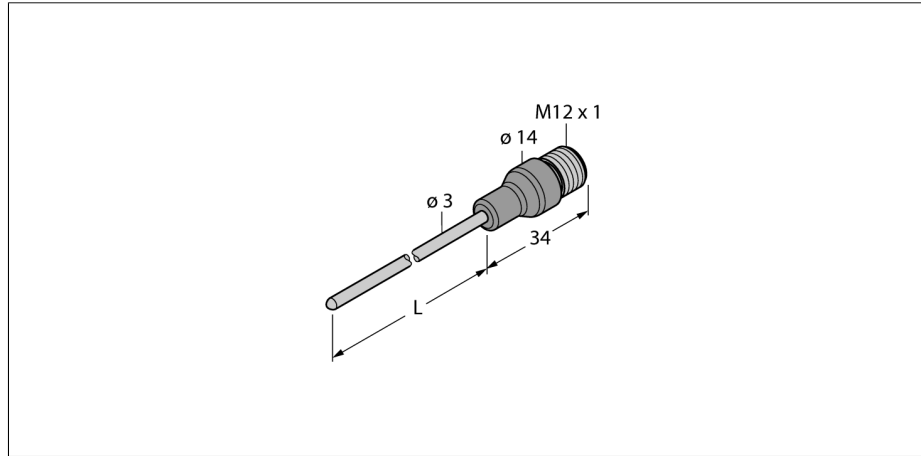

- Pt-100 probe acc. to DIN EN 60751
- Vibration and shock-resistant
- Connectable to TS, TTM, IM34, BL20, BL67
- Temperature range -50...500 °C
- 4-wire technology

**Wiring diagram**

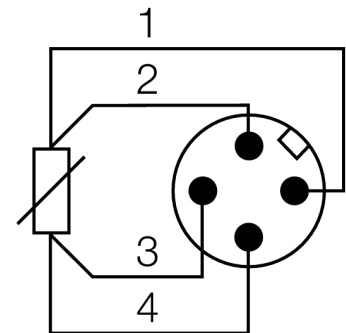

**General description**

Resistance thermometers come into operation when temperatures must be measured and monitored to control and optimize processes.

Typical applications are process plants, manufacturing facilities and units, as well as air-conditioning systems. The core element of the temperature sensors is a Pt 100 measuring resistor in 4-wire technology.



<b>Type code</b>	TP-203A-CF-H1141-L100
Ident no.	9910402
<b>Temperature operating range</b>	-50...500 °C
Measuring element	Pt-100 platinum measuring element, DIN EN 60751
Accuracy	Class A
Response time	t0.5 = 1.5 s / t0.9 = 6.0 s in water at @ 0.2 m/s
Immersion depth (L)	100 mm
<b>Protection type and class</b>	IP67
MTTF	2283 years acc. to SN 29500 (Ed. 99) 40 °C
<b>Ambient conditions</b>	
Ambient temperature	-40 ... 120 °C
Storage temperature	-40...+85°C
Pressure resistance	100 bar
<b>Housing</b>	
Housing material	Stainless steel/plastic, V4A (1.4404)
Sensor material	stainless steel, AISI 316L
Mechanical connection	for compression ferrule fittings, protective tubing or direct mounting
Connection	male, M12 x 1
Pressure resistance	100 bar
<b>Reference conditions acc. to IEC 61298-1</b>	
temperature	15...25 °C
Atmospheric pressure	860...1060 hPa abs.
Humidity	45...75 % rel.
Auxiliary power	24 VDC

**Temperature measurement  
Probe  
TP-203A-CF-H1141-L100**

**TURCK**

Industrial  
Automation

**Accessories**

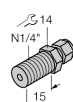
Type code	Ident no.	Description	Dimension drawing
CF-M-3-G1/8-A4	9910405	Compression ferrule fittings for direct mounting of temperature probes	
CF-M-3-N1/8-A4	9910406	Compression ferrule fittings for direct mounting of temperature probes	
CF-M-3-G1/4-A4	9910407	Compression ferrule fittings for direct mounting of temperature probes	
CF-M-3-N1/4-A4	9910408	Compression ferrule fittings for direct mounting of temperature probes	

**Wiring accessories**

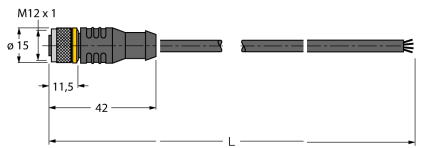
Type code	Ident no.	Description	Dimension drawing
RKC4.4T-2/TEL	6625013	Connection cable, female M12, straight, 4-pin, cable length: 2 m, sheath material: PVC, black; cULus approval; other cable lengths and qualities available, see <a href="http://www.turck.com">www.turck.com</a>	

**Temperature measurement  
Probe  
TP-203A-CF-H1141-L100**

**Wiring accessories**

Type code	Ident no.	Description	Dimension drawing
WKC4.4T-2/TEL	6625025	Connection cable, female M12, angled, 4-pin, cable length: 2 m, sheath material: PVC, black; cULus approval; other cable lengths and qualities available, see <a href="http://www.turck.com">www.turck.com</a>	
RKC4.4T-2/TXL	6625503	Connection cable, female M12, straight, 4-pin, cable length: 2 m, sheath material: PVC, black; cULus approval; other cable lengths and qualities available, see <a href="http://www.turck.com">www.turck.com</a>	
WKC4.4T-2/TXL	6625515	Connection cable, female M12, angled, 4-pin, cable length: 2 m, sheath material: PVC, black; cULus approval; other cable lengths and qualities available, see <a href="http://www.turck.com">www.turck.com</a>	