

**Temperature measurement
Accessories thermowell
THW-6-N1/2-A4-L150**

- Thermowell for temperature probes (6 mm diameter, TP series)
- Process connection 1/2" NPT male thread

General description

Thermowells protect the probes against aggressive media and high pressures. Direct contact with the medium is avoided when using thermowells for mounting. The probe can be replaced without interrupting the process.

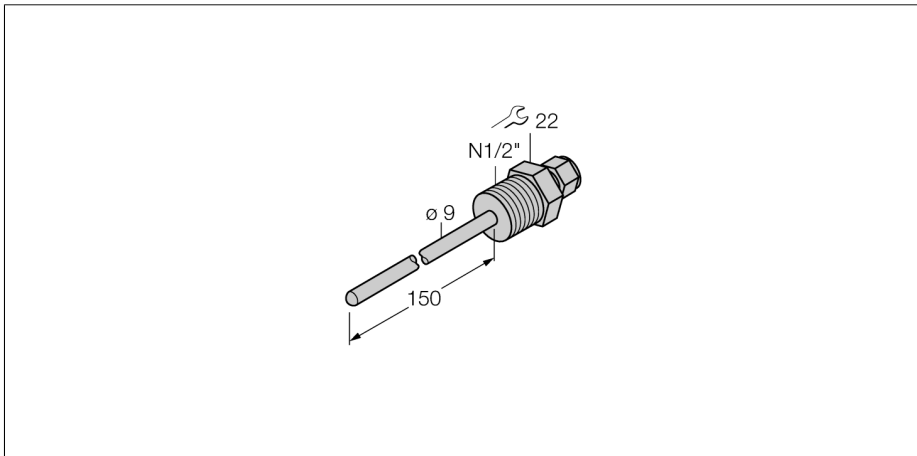

Type code	THW-6-N1/2-A4-L150
Ident no.	9910465
Temperature operating range	-50...350 °C
Immersion depth (L)	150 mm
Pressure resistance	400 bar
Housing	
Housing material	stainless steel 1.4404 (AISI 316L), V4A (1.4404)
Sealing material	stainless steel
Mechanical connection	NPT 1/2"
Pressure resistance	400 bar
Max. tightening torque housing nut	100 Nm