



RD0506LS-SB

Planar Ultrafast Rectifier 5A, 600V, TO-220F-2FS

ON Semiconductor®

<http://onsemi.com>

Features

- High breakdown voltage ($V_{RRM}=600V$)
- Easy to be mounted, good heat dissipation
- Low noise at the time of reverse recovery
- High reliability
- Reverse recovery time is fast
- Halogen free compliance

Specifications

Absolute Maximum Ratings at $T_a=25^\circ C$

Parameter	Symbol	Conditions	Ratings	Unit
Repetitive Peak Reverse Voltage	V_{RRM}		600	V
Average Output Current	I_O		5	A
Peak Output Current	I_{OP}	$PW \leq 100\mu s$, duty cycle $\leq 50\%$	20	A
Surge Forward Current	I_{FSM}	Sine wave, 10ms 1pulse	120	A
Junction Temperature	T_j		150	$^\circ C$
Storage Temperature	T_{stg}		-55 to +150	$^\circ C$

Stresses exceeding Maximum Ratings may damage the device. Maximum Ratings are stress ratings only. Functional operation above the Recommended Operating Conditions is not implied. Extended exposure to stresses above the Recommended Operating Conditions may affect device reliability.

Electrical Characteristics at $T_a=25^\circ C$

Parameter	Symbol	Conditions	Ratings			Unit
			min	typ	max	
Reverse Voltage	V_R	$I_R=1mA$	600			V
Forward Voltage	V_F	$I_F=5A$		1.3	1.6	V
Reverse Current	I_R	$V_R=600V$			50	μA
Reverse Recovery Time	t_{rr}	$I_F=5A$, $di/dt=100A/\mu s$			50	ns
Thermal Resistance	$R_{th(j-c)}$	Between the junction part and the case smoothing current			6.25	$^\circ C / W$

Package Dimensions

unit : mm (typ)

7532-001

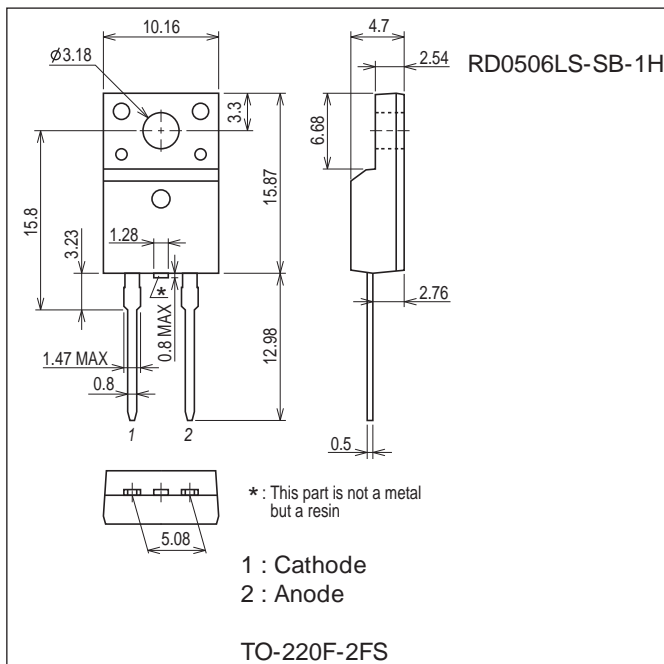

Ordering & Package Information

Device	Package	Shipping	memo
RD0506LS-SB-1H	TO-220F-2FS, SC-67 TO-220Full pack, 2-Lead	50pcs./ tube	Pb-Free and Halogen Free

Marking

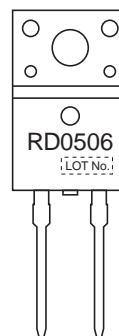

Electrical Connection



RD0506LS-SB

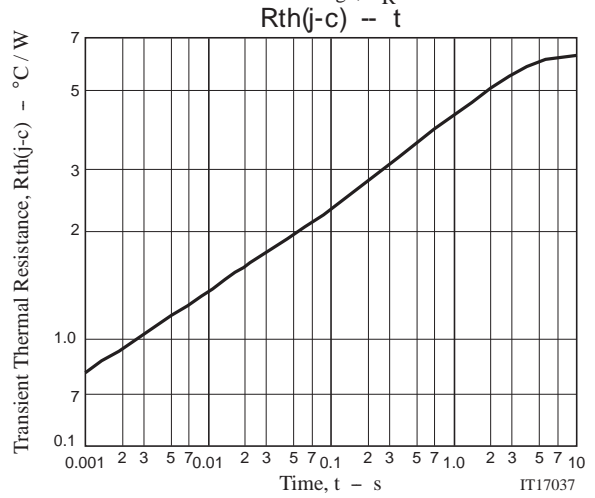
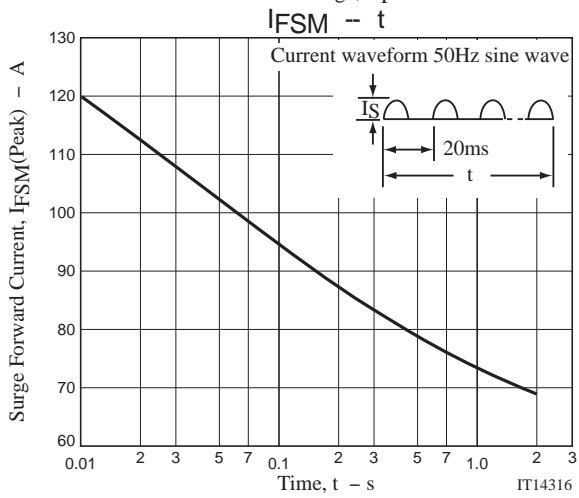
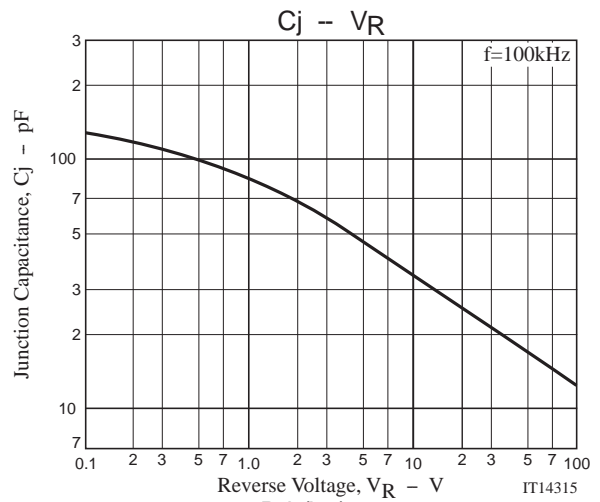
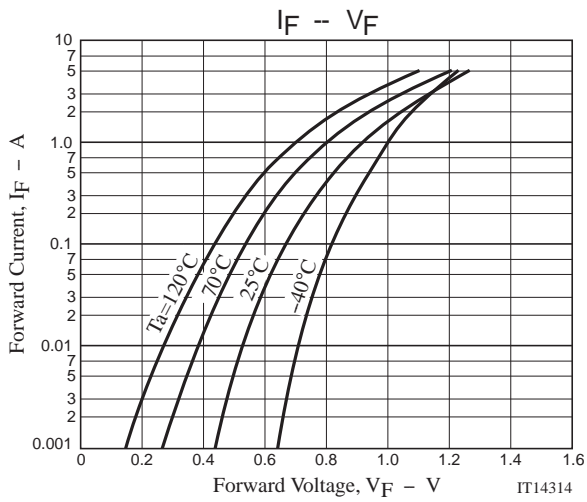

RD0506LS-SB

Magazine Specification

RD0506LS-SB-1H

1. Packing Format

Package Name	Magazine Name	Maximum Number of devices contained (pcs)			Packing format	
		Magazine	Inner box	Outer box	Inner BOX	Outer BOX
TO-220F-2FS	TO-220F	50	1,000	4,000	SPD-0V0001 20 magazines contained Dimensions:mm (external) 568×150×55	SPT-081029 4 inner boxes contained Dimensions:mm (external) 590×225×178

2. Magazine dimensions

(unit:mm)

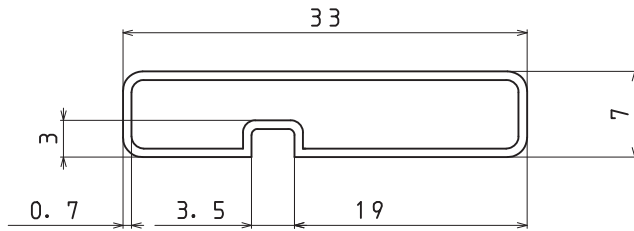

Tolerance=±0.3mm
 Thickness=0.7±0.2mm
 Length =532.5±2mm
 Material =PVC (Antistatic treatment)

3. Storage method to magazine

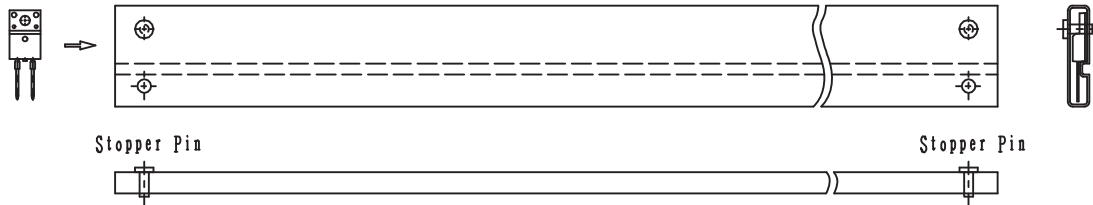

4. Inner box label (unit:mm)

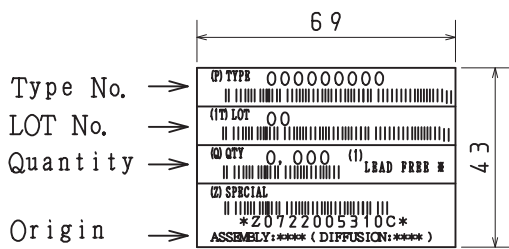

5. Outer box label (unit:mm)

It is a label at the time of factory shipments.
 The form of a label may change in physical
 distribution process.

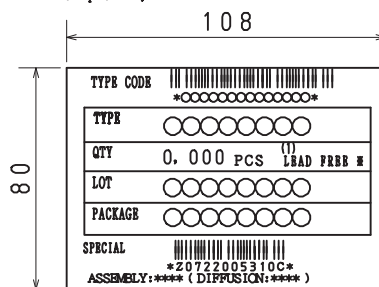

NOTE (1)

The LEAD FREE # description shows that the surface treatment of the terminal is lead free.

Label	JEITA Phase
LEAD FREE 3	JEITA Phase 3A

RD0506LS-SB

Outline Drawing RD0506LS-SB-1H

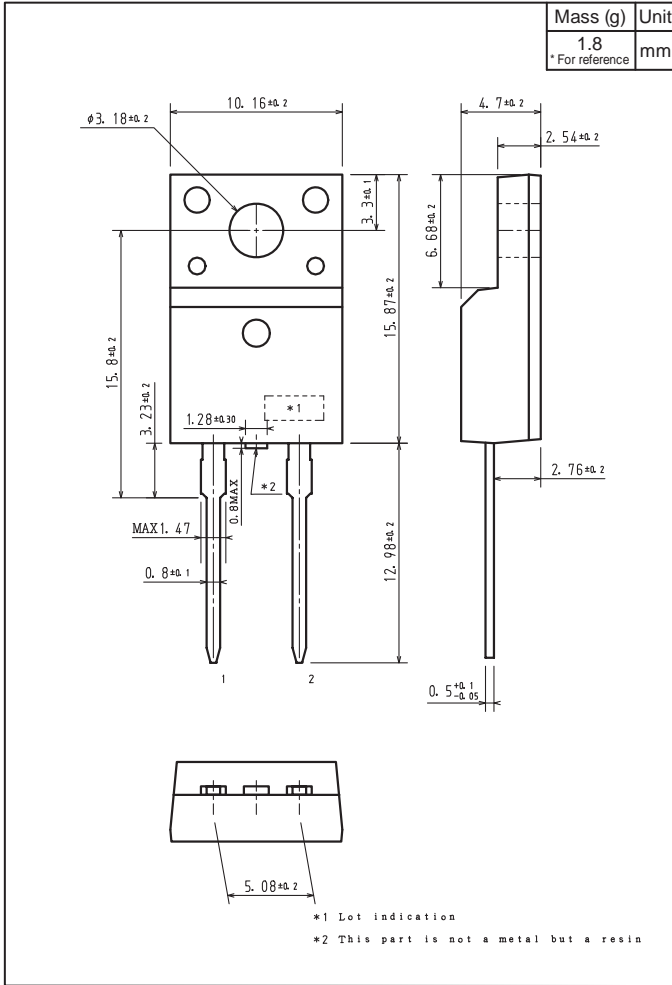

ON Semiconductor and the ON logo are registered trademarks of Semiconductor Components Industries, LLC (SCILLC). SCILLC owns the rights to a number of patents, trademarks, copyrights, trade secrets, and other intellectual property. A listing of SCILLC's product/patent coverage may be accessed at www.onsemi.com/site/pdf/Patent-Marking.pdf. SCILLC reserves the right to make changes without further notice to any products herein. SCILLC makes no warranty, representation or guarantee regarding the suitability of its products for any particular purpose, nor does SCILLC assume any liability arising out of the application or use of any product or circuit, and specifically disclaims any and all liability, including without limitation special, consequential or incidental damages. "Typical" parameters which may be provided in SCILLC data sheets and/or specifications can and do vary in different applications and actual performance may vary over time. All operating parameters, including "Typicals" must be validated for each customer application by customer's technical experts. SCILLC does not convey any license under its patent rights nor the rights of others. SCILLC products are not designed, intended, or authorized for use as components in systems intended for surgical implant into the body, or other applications intended to support or sustain life, or for any other application in which the failure of the SCILLC product could create a situation where personal injury or death may occur. Should Buyer purchase or use SCILLC products for any such unintended or unauthorized application, Buyer shall indemnify and hold SCILLC and its officers, employees, subsidiaries, affiliates, and distributors harmless against all claims, costs, damages, and expenses, and reasonable attorney fees arising out of, directly or indirectly, any claim of personal injury or death associated with such unintended or unauthorized use, even if such claim alleges that SCILLC was negligent regarding the design or manufacture of the part. SCILLC is an Equal Opportunity/Affirmative Action Employer. This literature is subject to all applicable copyright laws and is not for resale in any manner.