



## LPC1766-STK development board

## Users Manual



All boards produced by Olimex are ROHS compliant

Revision Initial, October 2009

Copyright(c) 2009, OLIMEX Ltd, All rights reserved

## **INTRODUCTION:**

LPC1766-STK is development board with LPC1766 Cortex M3 microcontroller from NXP. This powerful microcontroller supports various serial interfaces such as USB Device/Host/OTG, UART, CAN and other. On the board are available audio input and output, digital accelerometer, JTAG, Ethernet, TFT LCD and mini SD/MMC card connector. All this allows you to build a diversity of powerful applications to be used in a wide range of applications.

## **BOARD FEATURES:**

- MCU: **LPC1766** Cortex M3, 100 Mhz, 256KB Flash, 64KB RAM, Ethernet MAC, USB Host/ Device/OTG, x4 UARTS, CAN, SPI, SSP, I2C, I2S, ADC, DAC, TC
- LCD NOKIA 6610 128x128 x12bit color TFT with Epson LCD controller
- 3-axis digital accelerometer with 11 bit accuracy
- temperature sensor
- Ethernet 100Mbit
- CAN interface and connector
- USB host connector
- USB device connector
- USB OTG connector
- two user LEDs
- three user buttons
- joystick
- potentiometer
- micro SD/MMC card connector
- JTAG and TRACE connectors
- power supply
- RESET circuit
- UEXT connector
- Audio IN
- Audio OUT
- RTC battery
- FR-4, 1.5 mm, red soldermask, component print
- Dimensions:134.6x101.6mm (5.3 x 4.0")

## **ELECTROSTATIC WARNING:**

The **LPC1766-STK** board is shipped in protective anti-static packaging. The board must not be subject to high electrostatic potentials. General practice for working with static sensitive devices should be applied when working with this board.

## **BOARD USE REQUIREMENTS:**

**Cables:** The cable you will need depends on the programmer/debugger you use. If you use [ARM-JTAG-EW](#), you will need USB A-B cable. If you use a software programmer such as FlashMagic, you will need RS232 cable.

**Hardware:** Programmer/Debugger [ARM-JTAG-EW](#) or other compatible programming/debugging tool if you work with EW-ARM.

You can use also [ARM-USB-OCD](#), [ARM-USB-TINY](#), [ARM-USB-TINY-H](#) with CrossWorks or OpenOCD.

## **PROCESSOR FEATURES:**

**LPC1766-STK** board use ARM 32-bit Cortex™-M3 microcontroller **LPC1766FBD100** from NXP Semiconductors with these features:

- ARM Cortex-M3 processor, running at frequencies of up to 100 MHz. A Memory Protection Unit (MPU) supporting eight regions is included.
- ARM Cortex-M3 built-in Nested Vectored Interrupt Controller (NVIC).
- 256 kB on-chip flash programming memory. Enhanced flash memory accelerator enables high-speed 100 MHz operation with zero wait states.
- In-System Programming (ISP) and In-Application Programming (IAP) via on-chip bootloader software.
- On-chip SRAM includes:
  - 32 kB of SRAM on the CPU with local code/data bus for high-performance CPU access.
  - Two 16 kB SRAM blocks with separate access paths for higher throughput. These SRAM blocks may be used for Ethernet, USB, and DMA memory, as well as for general purpose CPU instruction and data storage.
- Eight channel General Purpose DMA controller (GPDMA) on the AHB multilayer matrix that can be used with the SSP, I2S-bus, UART, the Analog-to-Digital and Digital-to-Analog converter peripherals, timer match signals, and for memory-to-memory transfers.
- Multilayer AHB matrix interconnect provides a separate bus for each AHB master. AHB masters include the CPU, General Purpose DMA controller, Ethernet MAC, and the USB interface. This interconnect provides communication with no arbitration delays.

- Split APB bus allows high throughput with few stalls between the CPU and DMA.
- Serial interfaces:
  - Ethernet MAC with RMIi interface and dedicated DMA controller.
  - USB 2.0 full-speed device/Host/OTG controller with dedicated DMA controller and on-chip PHY for device, Host, and OTG functions.
  - Four UARTs with fractional baud rate generation, internal FIFO, DMA support, and RS-485 support. One UART has modem control I/O, and one UART has IrDA support.
  - CAN 2.0B controller with two channels.
  - SPI controller with synchronous, serial, full duplex communication and programmable data length.
  - Two SSP controllers with FIFO and multi-protocol capabilities. The SSP interfaces can be used with the GPDMA controller.
  - Two I2C-bus interfaces supporting fast mode with a data rate of 400 kbits/s with multiple address recognition and monitor mode.
  - One I2C-bus interface supporting full I2C-bus specification and fast mode plus with a data rate of 1 Mbit/s with multiple address recognition and monitor mode.
  - I2S (Inter-IC Sound) interface for digital audio input or output, with fractional rate control. The I2S-bus interface can be used with the GPDMA. The I2S-bus interface supports 3-wire and 4-wire data transmit and receive as well as master clock input/output.
- Other peripherals:
  - 70 General Purpose I/O (GPIO) pins with configurable pull-up/down resistors and a new, configurable open-drain operating mode.
  - 12-bit Analog-to-Digital Converter (ADC) with input multiplexing among eight pins, conversion rates up to 1 MHz, and multiple result registers. The 12-bit ADC can be used with the GPDMA controller.
  - 10-bit Digital-to-Analog Converter (DAC) with dedicated conversion timer and DMA support.
  - Four general purpose timers/counters, with a total of eight capture inputs and ten compare outputs. Each timer block has an external count input and DMA support.
  - One motor control PWM with support for three-phase motor control.
  - Quadrature encoder interface that can monitor one external quadrature encoder.
  - One standard PWM/timer block with external count input.
  - RTC with a separate power domain and dedicated RTC oscillator. The RTC block includes 64 bytes of battery-powered backup registers.
  - Watchdog Timer (WDT) resets the microcontroller within a reasonable amount of time if it enters an erroneous state.
  - System tick timer, including an external clock input option.

- Repetitive interrupt timer provides programmable and repeating timed interrupts.
  - Each peripheral has its own clock divider for further power savings.
- Standard JTAG test/ debug interface for compatibility with existing tools. Serial Wire Debug and Serial Wire Trace Port options.
- Emulation trace module enables non-intrusive, high-speed real-time tracing of instruction execution.
- Integrated PMU (Power Management Unit) automatically adjusts internal regulators to minimize power consumption during Sleep, Deep sleep, Power-down, and Deep power-down modes.
- Four reduced power modes: Sleep, Deep-sleep, Power-down, and Deep power-down.
- Single 3.3 V power supply (2.4 V to 3.6 V).
- Four external interrupt inputs configurable as edge/level sensitive. All pins on PORT0 and PORT2 can be used as edge sensitive interrupt sources.
- Non-maskable Interrupt (NMI) input.
- Clock output function that can reflect the main oscillator clock, IRC clock, RTC clock, CPU clock, and the USB clock.
- The Wakeup Interrupt Controller (WIC) allows the CPU to automatically wake up from any priority interrupt that can occur while the clocks are stopped in deep sleep, Power-down, and Deep power-down modes.
- Processor wake-up from Power-down mode via interrupts from various peripherals.
- Brownout detect with separate threshold for interrupt and forced reset.
- Power-On Reset (POR).
- Crystal oscillator with an operating range of 1 MHz to 25 MHz.
- 4 MHz internal RC oscillator trimmed to 1 % accuracy that can optionally be used as a system clock.
- PLL allows CPU operation up to the maximum CPU rate without the need for a high-frequency crystal. May be run from the main oscillator, the internal RC oscillator, or the RTC oscillator.
- USB PLL for added flexibility.
- Code Read Protection (CRP) with different security levels.

# BLOCK DIAGRAM:

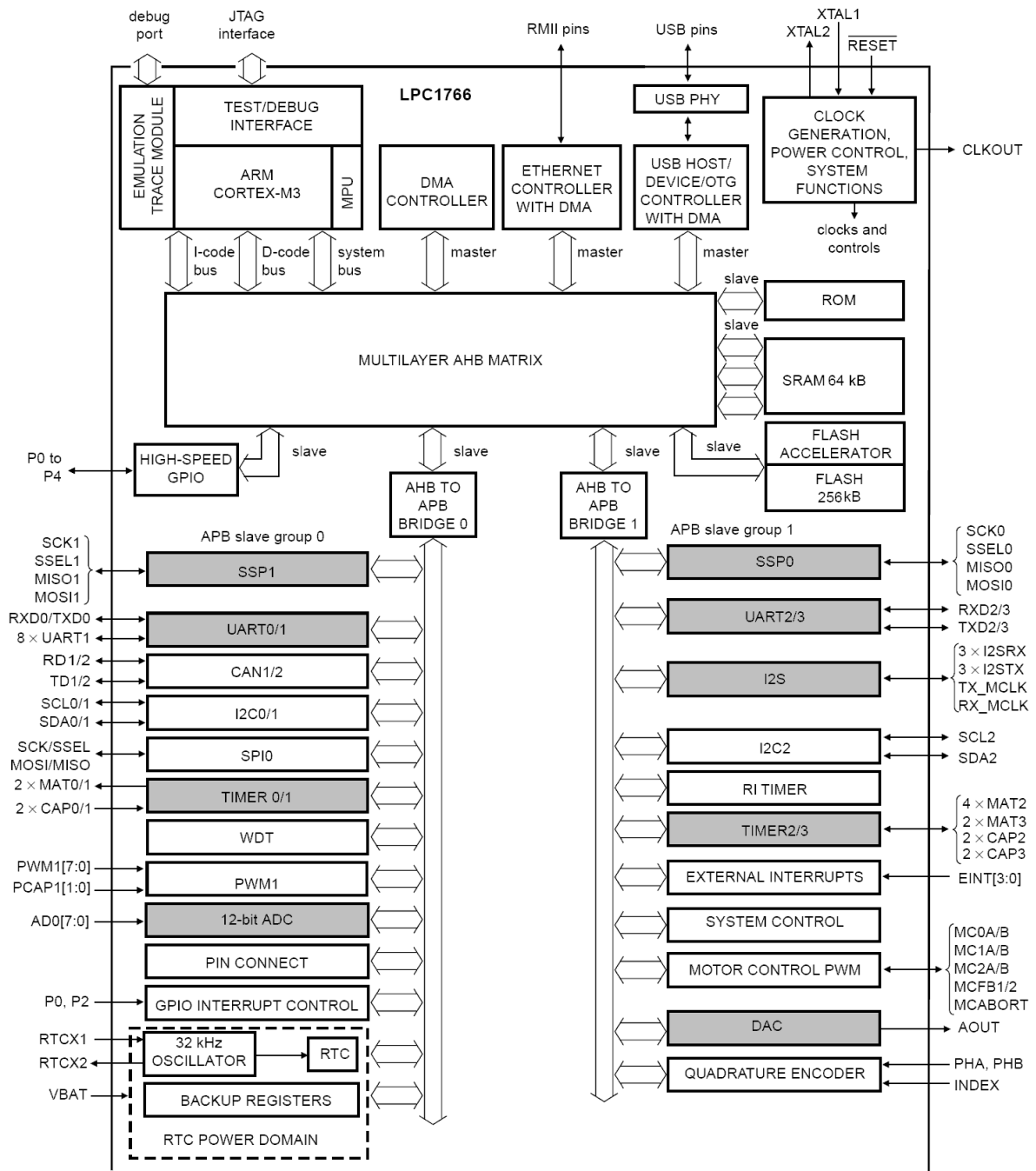

Grey-shaded blocks represent peripherals with connection to the GPDMA.

# MEMORY MAP:

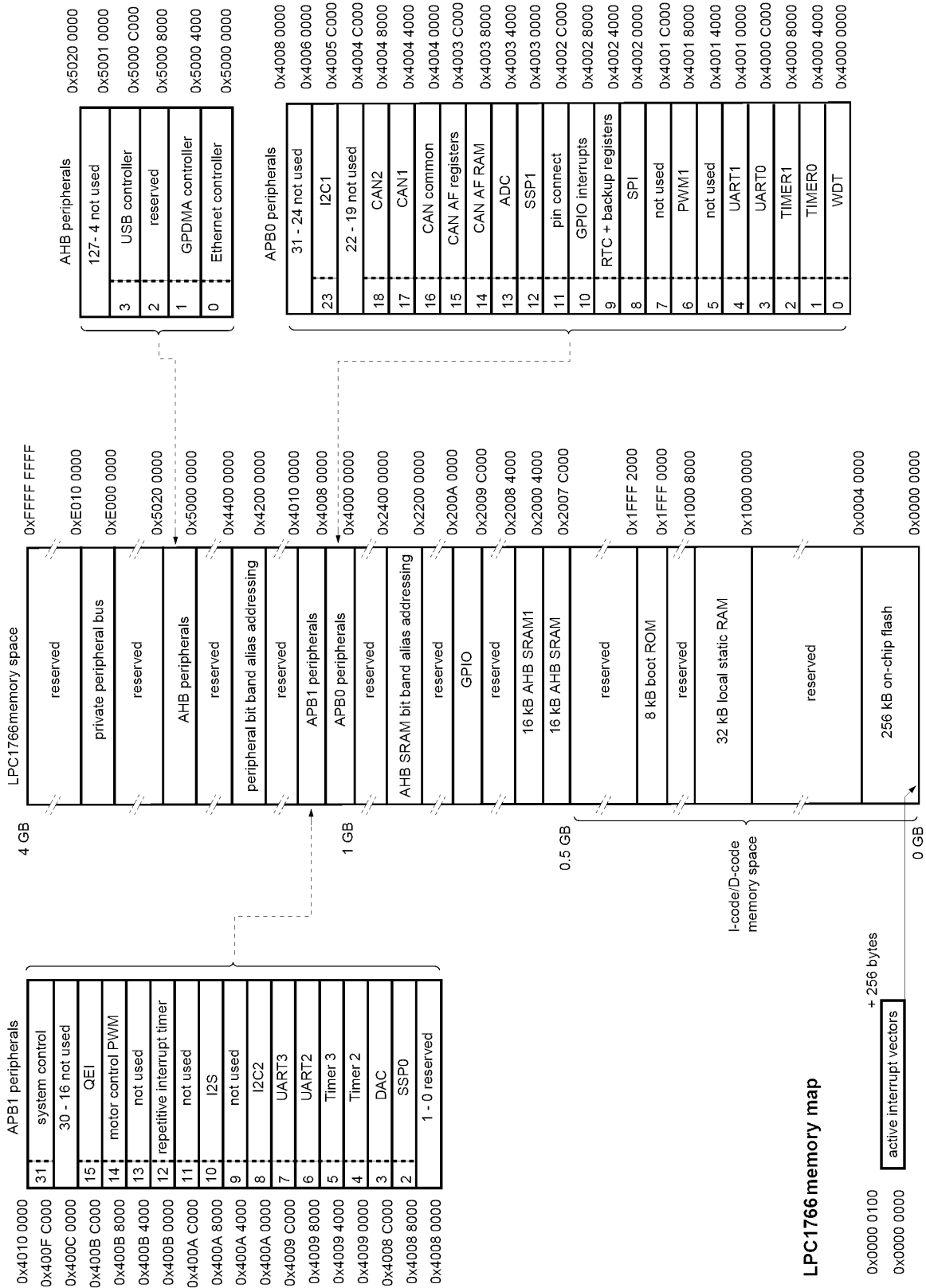

**SCHEMATIC:**

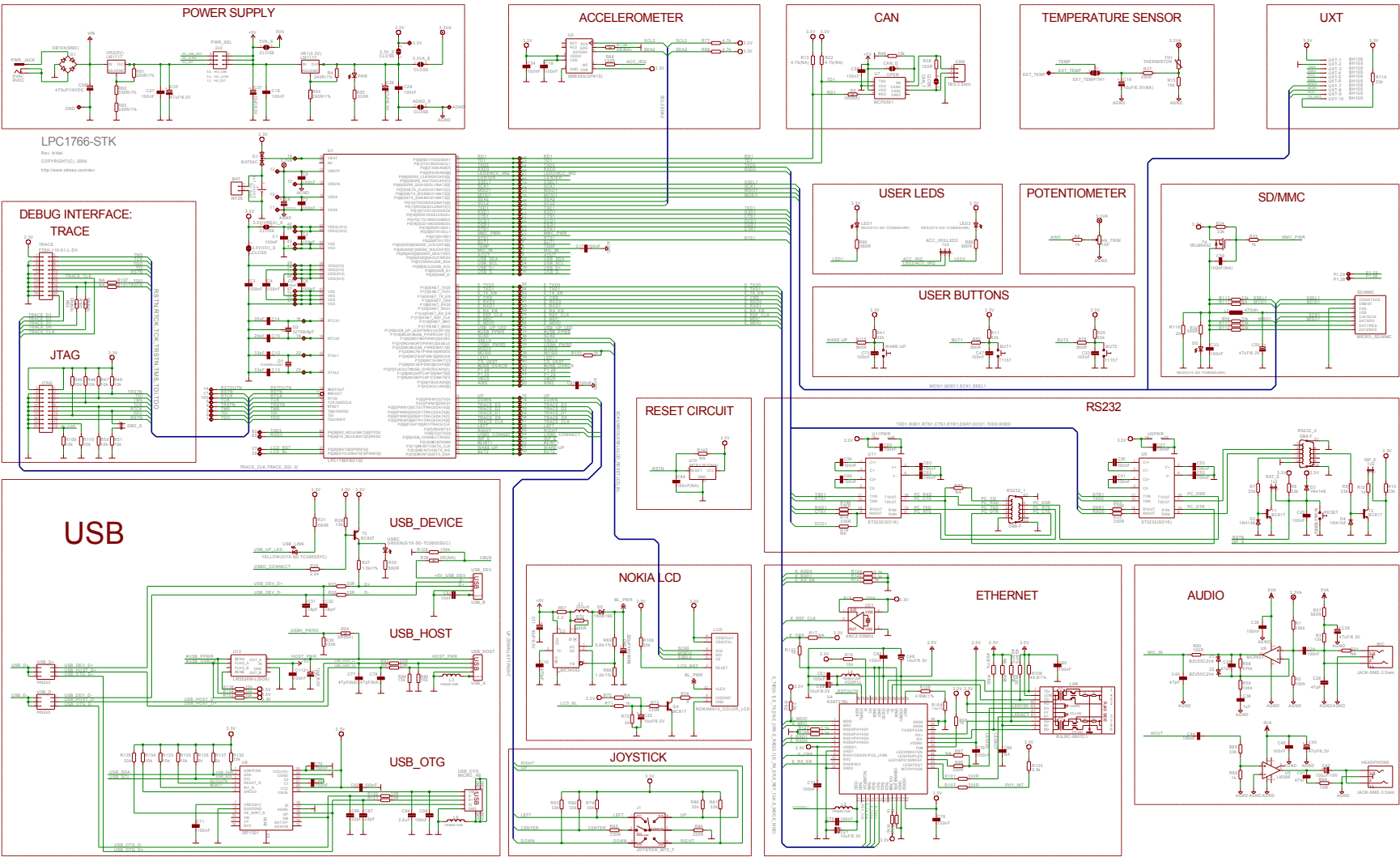



## BOARD LAYOUT:

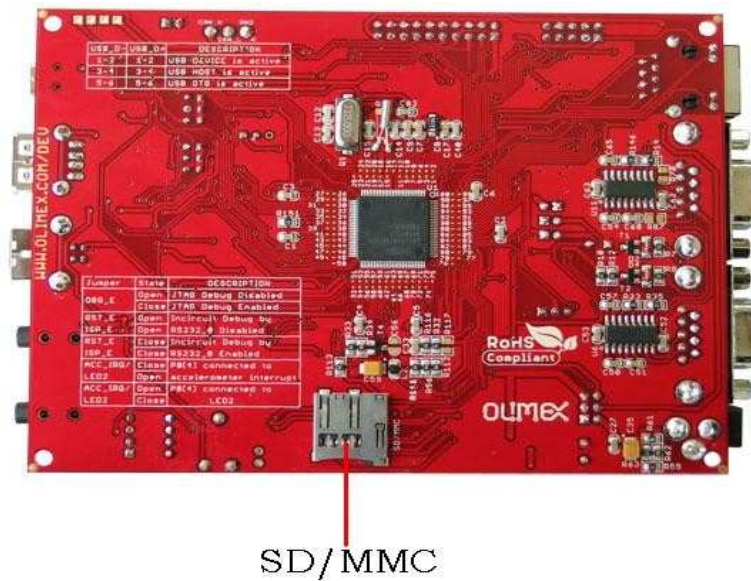
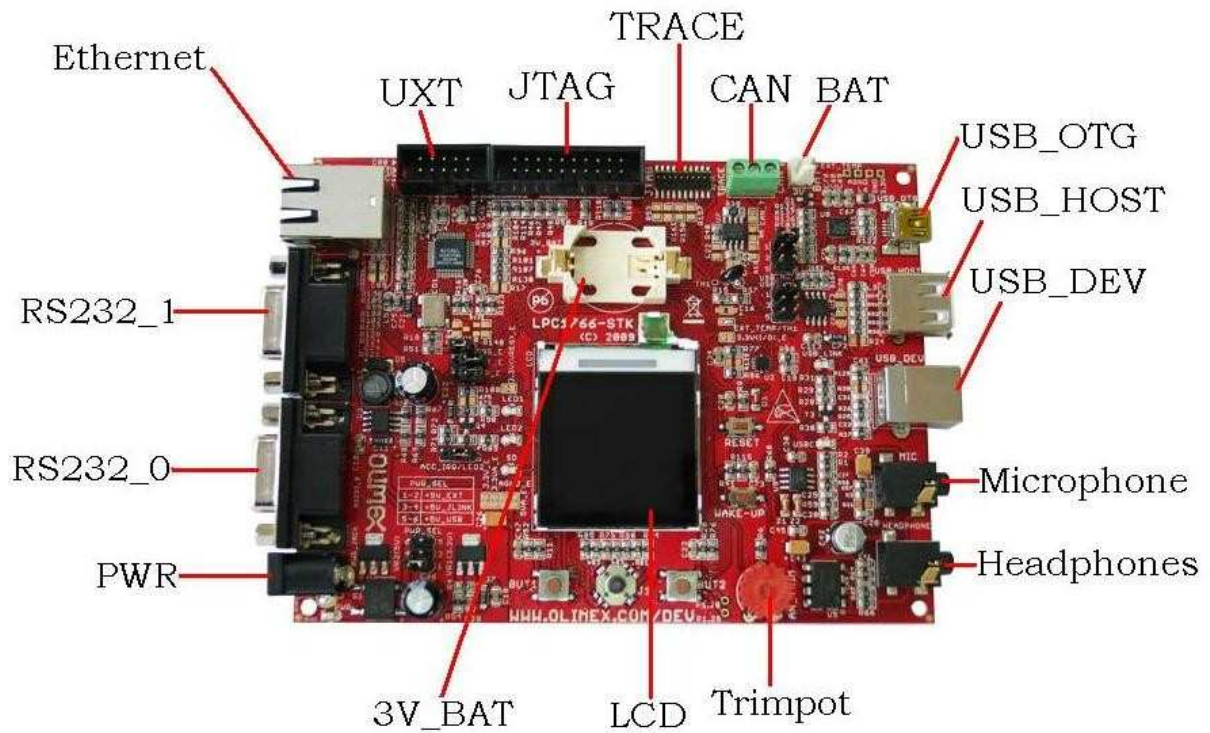

## POWER SUPPLY CIRCUIT:

LPC1766-STK is typically power supplied with 9 VDC.

The programmed board power consumption is about 200 mA with all peripherals enabled

## **RESET CIRCUIT:**

LPC1766-STK reset circuit includes jumper RST\_E, pin 15 of JTAG connector, pin 10 of TRACE connector and RESET button.

## **CLOCK CIRCUIT:**

Quartz crystal 12 MHz is connected to LPC1766 pin 22 (XTAL1) and pin 23 (XTAL2).

Quartz crystal 32.768 kHz is connected to LPC1766 pin 16 (RTCX1) and pin 18 (RTCX2).

## **JUMPER DESCRIPTION:**

### **CAN\_D**



CAN Disable. If this jumper is closed, the CAN is disabled.  
Default state is open.

### **CAN\_T**



This jumper assures correct work of the CAN. At each end of the bus it should be closed. This means that if you have only two devices with CAN, the jumpers of both devices should be closed. If you have more than two devices, only the two end-devices should be closed.

Default state is closed.

### **3.3V(VREG)\_E**



This jumper, when closed, supplies 3.3 V voltage for the on-chip voltage regulator only - 42 and 84 pins of the MCU.

Default state is closed.

### **3.3V\_E**



This jumper, when closed, enable the main 3.3 V regulator VR1(3.3V) - LM1117.  
Default state is closed.

### **3.3VA\_E**



This jumper, when closed, supplies 3.3 V voltage to the VDDA and VREFP pins of the MCU.

Default state is closed.

### **3.3V(I/O)\_E**



This jumper, when closed, supplies 3.3 V voltage to the VDD - 4 pins of the MCU.  
Default state is closed.

## 5VA\_E



This jumper, when closed, supplies analog 5V voltage supply to the audio amplifiers.

Default state is closed.

## AGND\_E



This jumper, when closed, connects analog GND to the GND of the MCU.

Default state is closed.

## EXT\_TEMP/TH1



This jumper, when is in position EXT\_TEMP – takes signal from external temperature sensor and when is in position TH1 – takes signal from the thermistor TH1 of the board.

Default state is in position TH1.

## DBG\_E



The position of this jumper doesn't matter.

Default state is closed.

## RST\_E



This jumper, when closed, enables programing via RS232.

Default state is open.

## ISP\_E



This jumper, when closed, enables programing via RS232.

Default state is open.

## ACC\_IRQ/LED2



This jumper when is in position ACC\_IRQ – enables interrupt request from the accelerometer and when is in position LED2 – enables LED2.

Default state is LED2.

## USB\_D-

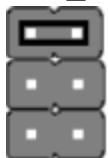

This jumper, when 1-2 are shorted – enables USB DEVICE, when 3-4 are shorted – enables USB HOST and when 5-6 are shorted – enables USB OTG.

Default state is 1-2.

## USB\_D+

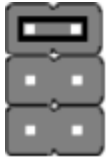

This jumper, when 1-2 are shorted – enables USB DEVICE, when 3-4 are shorted – enables USB HOST and when 5-6 are shorted – enables USB OTG.

Default state is 1-2.

## PWR\_SEL

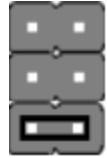

When 1-2 are shorted – the board is supplied from PWR\_JACK, when 3-4 are shorted – the board is supplied from JTAG and when 5-6 are shorted – the board is supplied from USB\_DEV.

Default state is 1-2.

## INPUT/OUTPUT:

**LED1 (red)** connected to LPC1766 pin 39 (P1[25]/MC1A/MAT1[1]).

**LED2 (red)** connected to LPC1766 pin 81 (P0[4]/I2SRX\_CLK/RD2/CAP2[0]) via jumper ACC\_IRQ/LED2, when this jumper is in position LED2.

**SD/MMC LED (red)** connected to SD/MMC pin 4 (VDD).

**Power-on LED (red)** with name **PWR** – this LED shows that +3.3V is applied to the board.

**USB\_UP\_LED** with name **USB\_LINK (yellow)** connected to **LPC1766** pin 32 (P1[18]/USB\_UP\_LED/PWM1[1]/CAP1[0]).

**USBD\_CONNECT LED** with name **USBC(green)** connected to **LPC1766** pin 64 (P2[9]/USB\_CONNECT/RXD2) through T3 and R29.

**User button** with name **BUT1** connected to **LPC1766** pin 9 (P0[23]/AD0[0]/I2SRX\_CLK/CAP3[0]).

**User button** with name **BUT2** connected to **LPC1766** pin 50 (P2[13]/#EINT3/I2STX\_SDA).

**User button** with name **WAKE-UP** connected to **LPC1766** pin 51 (P2[12]/#EINT2/I2STX\_WS).

**User button** with name **RESET** connected to **LPC1766** pin 17 (#RESET).

**Joystick button** with name **J1** this is 4 directions plus center button, in the schematic the joystick four directions switches are connected through 33k resistors to **LPC1766** pins - 65 (P2[8]/TD2/TXD2) – RIGHT, 66 (P2[7]/RD2/RTS1) – LEFT, 74 (P2[1]/PWM1[2]/RXD1) – DOWN, 75 (P2[0]/PWM1[1]/TXD1) – UP, the center button is connected to pin 80 (P0[5]/I2SRX\_WS/TD2/CAP2[1]).

**Trimpot** with name **AN\_TRIM** connected to **LPC1766** pin 20 (P1[31]/SCK1/AD0[5]).

**TFT LCD** - 128x128 12 bit color with backlight.

## EXTERNAL CONNECTORS DESCRIPTION:

### RS232 0:

Pin #	Signal Name
1	NC
2	T2OUT
3	R2IN
4	RST_E
5	GND
6	NC
7	ISP_E
8	NC
9	NC

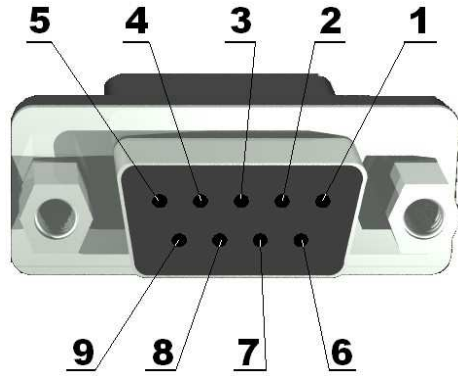

### RS232 1:

Pin #	Signal Name
1	PC_CD
2	PC_RXD
3	PC_TXD
4	PC_DTR
5	GND
6	PC_DSR
7	PC_RTS
8	PC_CTS
9	NC

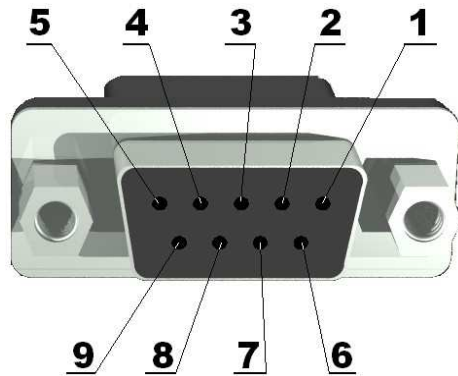

## PWR JACK:

Pin #	Signal Name
1	Power Input
2	GND

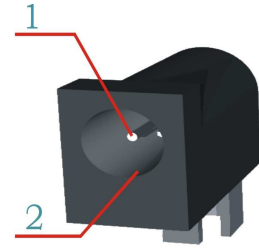

## UXT:

Pin #	Signal Name
1	3.3V
2	GND
3	TXD3
4	RXD3
5	SCL2
6	SDA2
7	MISO1
8	MOSI1
9	SCK1
10	CS_UEXT

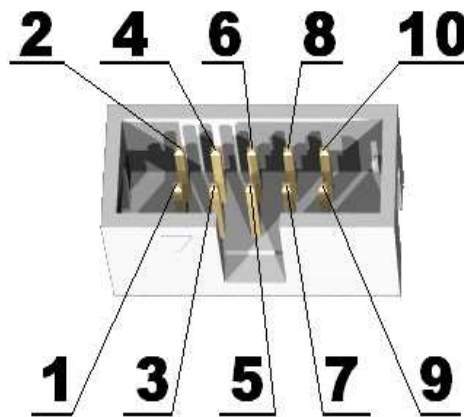

## JTAG:

The JTAG connector allows the software debugger to talk via a JTAG (Joint Test Action Group) port directly to the core. Instructions may be inserted and executed by the core thus allowing LPC1766 memory to be programmed with code and executed step by step by the host software.

For more details refer to IEEE Standard 1149.1 - 1990 Standard Test Access Port and Boundary Scan Architecture and LPC1766 datasheets and users manual.

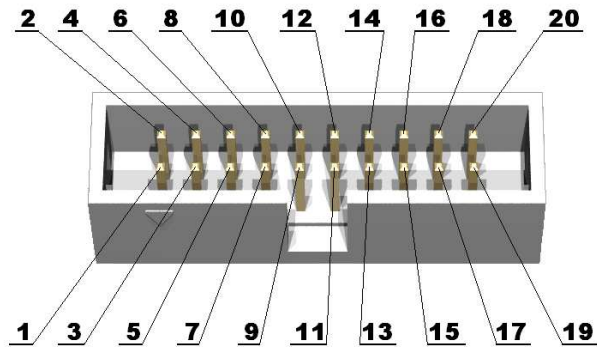

Pin #	Signal Name	Pin #	Signal Name
1	3.3V	2	3.3V
3	TRSTN	4	GND
5	TDI	6	GND
7	TMS	8	GND
9	TCK	10	GND
11	RTCK	12	GND
13	TDO	14	GND
15	RSTN	16	GND
17	through 10K to GND	18	GND
19	+5V_JLINK	20	GND

**LAN:**

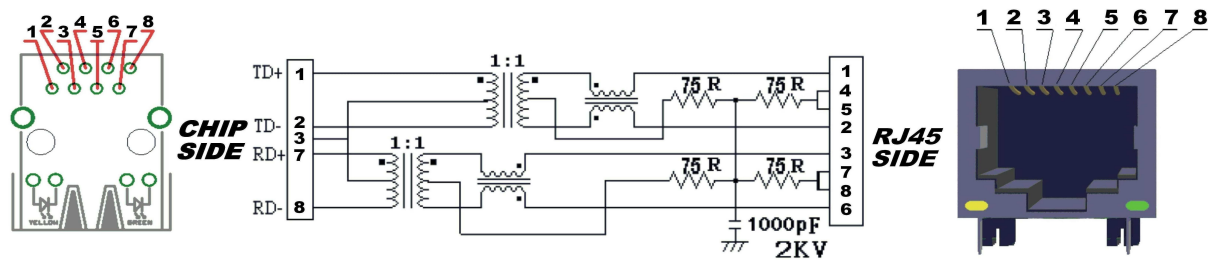

Pin #	Signal Name Chip Side	Pin #	Signal Name Chip Side
1	TPOUT+	5	Not Connected (NC)
2	TPOUT-	6	Not Connected (NC)
3	2.5V	7	TPIN+
4	Not Connected (NC)	8	TPIN-

LED	Color	Usage
Right	Yellow	Activity
Left	Green	100MBits/s (Half/Full duplex)

## CAN

Pin#	Signal	Description
1	GND	Ground
2	CANL	CAN LOW
3	CANH	CAN HIGH



## TRACE

Pin#	Signal	Description	Pin#	Signal	Description
1	VCC	3,3V	2	TMS	
3	GND		4	TCK	
5	GND		6	TDO	
7	NC		8	TDI	
9	GND		10	RSTN	
11	GND		12	TRACE_CLK	
13	GND		14	TRACE_D0/TDO	Depends on R150/R157
15	GND		16	TRACE_D1/TRST	Depends on R153/R161
17	GND		18	TRACE_D2	
19	GND		20	TRACE_D3	



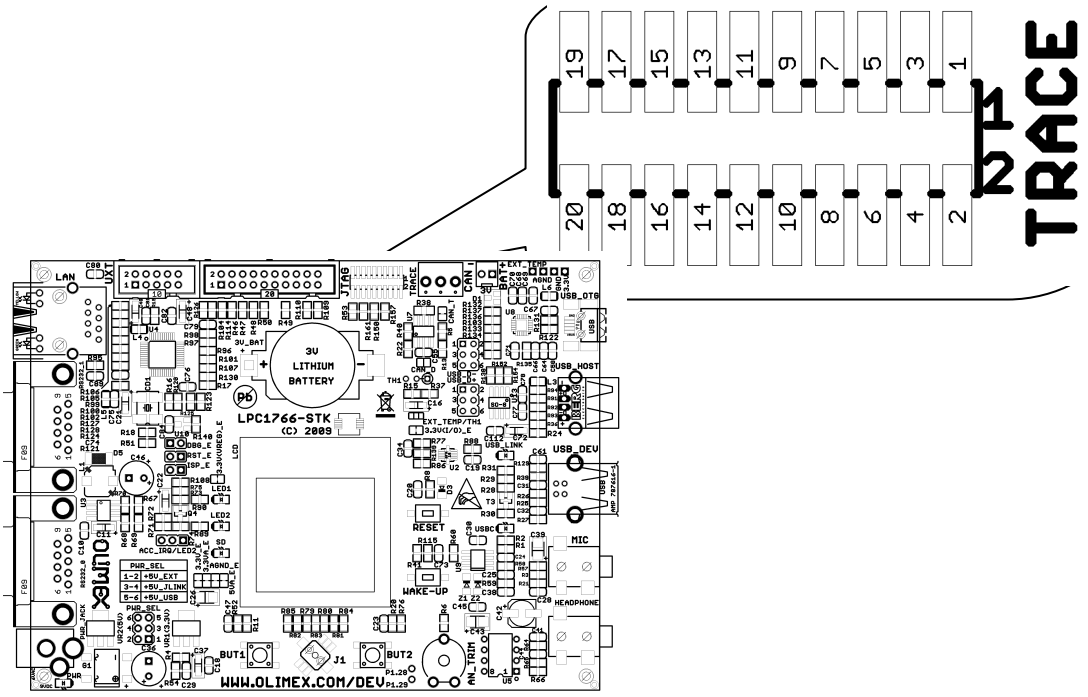

## USB HOST

Pin #	Signal Name
1	HOST_PWR
2	USB_HOST_D-
3	USB_HOST_D+
4	GND

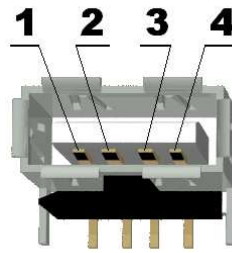

USB 2.0 full-speed Host controller with dedicated DMA controller and on-chip PHY. The host controller enables full- and low-speed data exchange with USB devices attached to the bus. It consists of a register interface, a serial interface engine, and a DMA controller. The register interface complies with the OHCI specification.

## USB DEVICE

Pin #	Signal Name
1	+5V_USB_DEV
2	USB_DEV_D-
3	USB_DEV_D+
4	GND

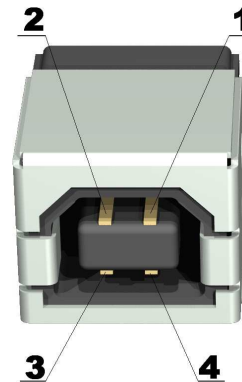

The device controller enables 12 Mbit/s data exchange with a USB Host controller. It consists of a register interface, serial interface engine, endpoint buffer memory, and a DMA controller. The serial interface engine decodes the USB data stream and writes data to the appropriate endpoint buffer. The status of a completed USB transfer or error condition is indicated via status registers. An interrupt is also generated if enabled. When enabled, the DMA controller transfers data between the endpoint buffer and the on-chip SRAM.

## USB OTG

Pin #	Signal Name
1	VBUS
2	USB_OTG_D-
3	USB_OTG_D+
4	USB_OTG_ID
5	GND

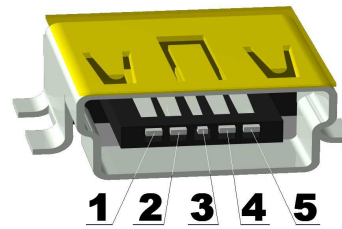

USB OTG is a supplement to the USB 2.0 specification that augments the capability of existing mobile devices and USB peripherals by adding host functionality for connection to USB peripherals.

The OTG Controller integrates the host controller, device controller, and a master-only I2C-bus interface to implement OTG dual-role device functionality. The dedicated I2C-bus interface controls an external OTG transceiver.

## BAT

Pin #	Signal Name
1	to 3.3V
2	GND

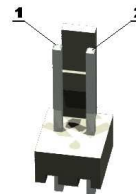

## MIC

Pin #	Signal Name
1	AGND
2	NC
3	MIC

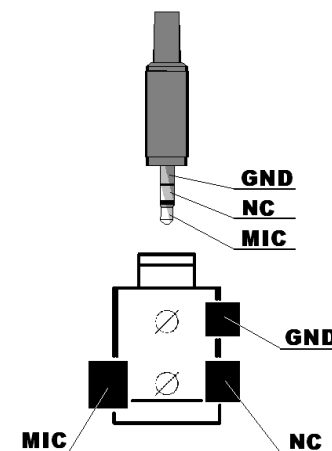

## HEADPHONE

Pin #	Signal Name
1	AGND
2	IN1=IN2
3	IN2=IN1

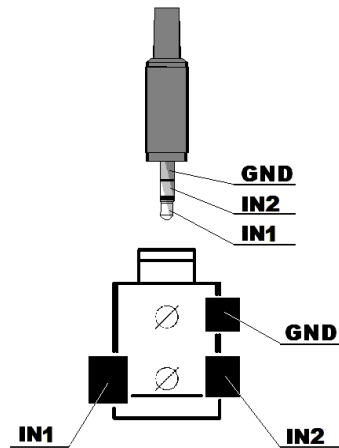

## SD/MMC

Pin #	Signal Name
1	Pull-up
2	SSEL1
3	MOSI1
4	VDD (power supply)
5	SCK1
6	GND
7	MISO1
8	Pull-up
9	Not connected
10	Not connected
11	Not connected
12	Not connected

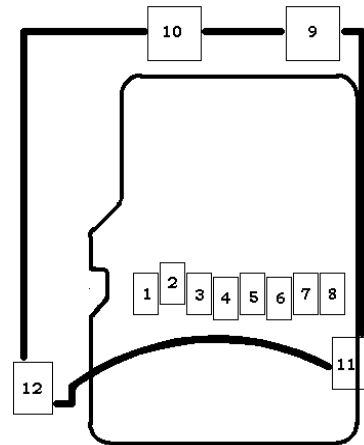

# MECHANICAL DIMENSIONS:

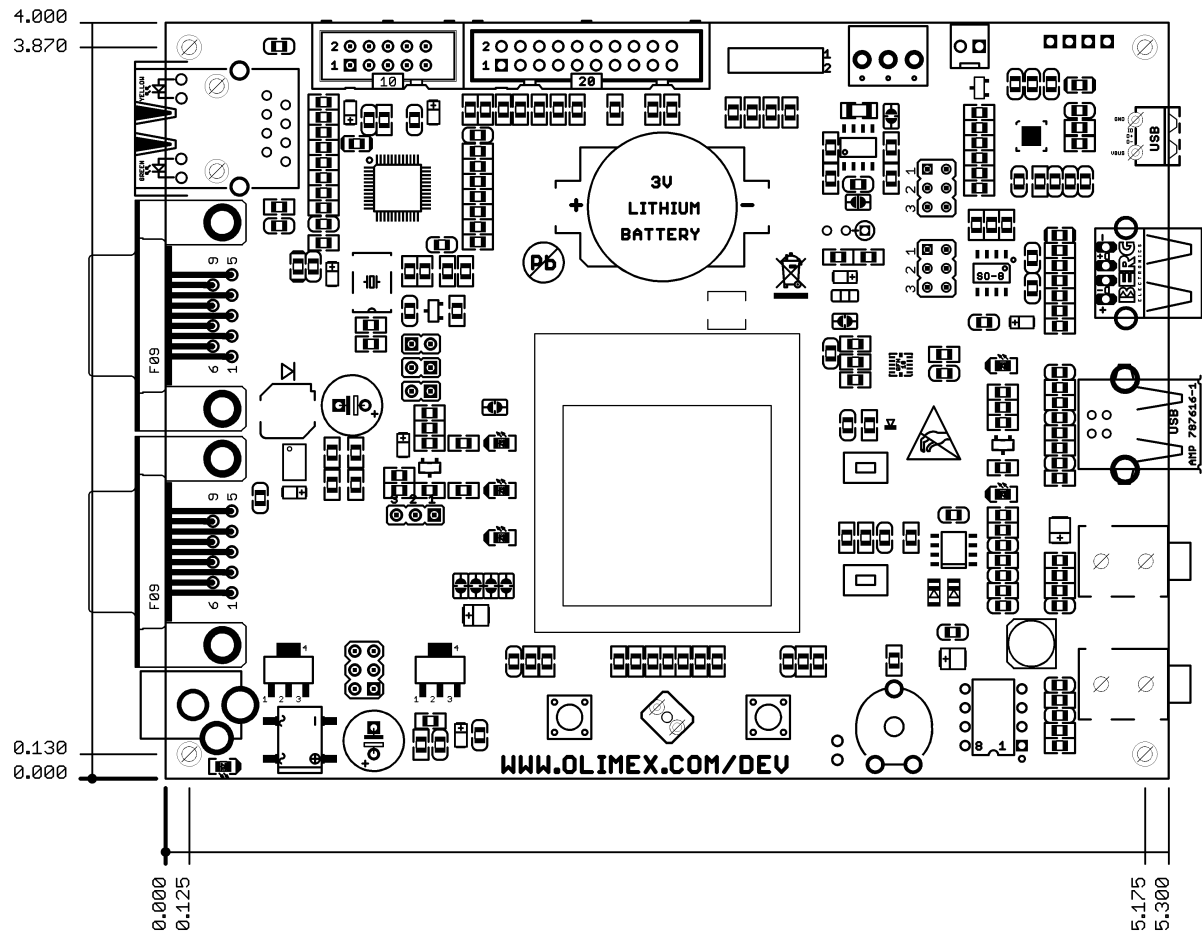

All measures are in Inches.

## AVAILABLE DEMO SOFTWARE:

- **Accelerometer Demo** - Basic use of I/O, timer, interrupt controllers, LDC module and the on board accelerometer EW-ARM 5.40.
- **Audio Device Class** - USB audio device class with one output and one input EW-ARM 5.40.
- **Getting Started** - Basic use of I/O, timer and interrupt controllers EW-ARM 5.40.
- **LCD Demo** - Basic use of the I/O, timer, interrupt controllers and LDC module for graphic and text drawing EW-ARM 5.40.
- **Mass Storage Class** - USB mass storage class with MMC/SD card drive EW-ARM 5.40.
- **Simple peripherals** - Simple ADC demo, Basic use of ADC, Simple DAC demo, Basic use of DAC, Simple DMA demo, Basic use of DMA, Simple EMAC demo, Basic use of EMAC, Simple EXTINT demo, Basic use of EXTINT, Simple GPIO demo, Basic use of GPIO, Simple RTC demo, Basic use of RTC, Simple SSP demo, Basic use of SSP, Simple Timer demo, Basic use of Timer, Simple UART demo, Basic use of UART, Simple WDT demo, Basic use of WDT EW-ARM 5.40.
- **uIP WEB Server** - WEB server application running on the top of the uIP 1.0 TCP-IP stack EW-ARM 5.40.
- **USB Host Demo** - USB host masstorage class framework EW-ARM 5.40.
- **USB Mouse** - USB HID class (Mouse) EW-ARM 5.40.
- **Virtual COM Port** - USB communication device class EW-ARM 5.40.

**ORDER CODE: LPC-1766STK** - assembled and tested board

**How to order?**

You can order to us directly or by any of our distributors.  
Check our web [www.olimex.com/dev](http://www.olimex.com/dev) for more info.

**Revision history:**

Revision Initial, October 2009

**Disclaimer:**

© 2009 Olimex Ltd. All rights reserved. Olimex®, logo and combinations thereof, are registered trademarks of Olimex Ltd. Other terms and product names may be trademarks of others.

The information in this document is provided in connection with Olimex products. No license, express or implied or otherwise, to any intellectual property right is granted by this document or in connection with the sale of Olimex products.

Neither the whole nor any part of the information contained in or the product described in this document may be adapted or reproduced in any material from except with the prior written permission of the copyright holder.

The product described in this document is subject to continuous development and improvements. All particulars of the product and its use contained in this document are given by OLIMEX in good faith. However all warranties implied or expressed including but not limited to implied warranties of merchantability or fitness for purpose are excluded.

This document is intended only to assist the reader in the use of the product. OLIMEX Ltd. shall not be liable for any loss or damage arising from the use of any information in this document or any error or omission in such information or any incorrect use of the product.