

## AVR- M16L development board

## Users Manual



All boards produced by Olimex are ROHS compliant

Rev. C, January 2005

Copyright(c) 2009, OLIMEX Ltd, All rights reserved

## INTRODUCTION

AVR-M16L is header board with JTAG connector and Atmega16L - 8-bit Microcontroller with 16K Bytes In-System Programmable Flash.

## BOARD FEATURES

- JTAG 5x2 pin connector for in-circuit programming and debugging with AVR-JTAG-L or AVR-JTAG-USB
- pin to pin compatible to AT90S8535 and may be used with AVR-P40B-8535-xMhz prototype boards
- ATmega16L-08AC avr microcontroller
- power supply filtering capacitors
- extension pin headers for each uC pin
- FR-4, 1.5 mm (0,062"), green soldermask, white silkscreen component print
- dimensions 51x19 mm (2"x0.73")

## ELECTROSTATIC WARNING

The AVR-M16L board is shipped in protective anti-static packaging. The board must not be subject to high electrostatic potentials. General practice for working with static sensitive devices should be applied when working with this board.

## BOARD USE REQUIREMENTS

**Cables:** The cable you will need depends on the programmer/debugger you use. If you use AVR-JTAG, if you use AVR-USB-JTAG you will need 1.8 m A-B USB cable.

**Hardware:** One of OLIMEX Programmers/Debuggers - [AVR-JTAG](#), [AVR-USB-JTAG](#), or other compatible Programmer/Debugger.

**Software:** AVR C compiler.

## PROCESSOR FEATURES

AVR-M16L board use High-performance, Low-power AVR® 8-bit Microcontroller

- ATmega16L from Atmel Corporation with these features:
  - Advanced RISC Architecture
    - 131 Powerful Instructions - Most Single-clock Cycle Execution
    - 32 x 8 General Purpose Working Registers
    - Fully Static Operation
    - Up to 16 MIPS Throughput at 16 MHz
    - On-chip 2-cycle Multiplier
  - High Endurance Non-volatile Memory segments
    - 16K Bytes of In-System Self-programmable Flash program memory
    - 512 Bytes EEPROM
    - 1K Byte Internal SRAM
    - Write/Erase Cycles: 10,000 Flash/100,000 EEPROM
    - Data retention: 20 years at 85°C/100 years at 25°C
    - Optional Boot Code Section with Independent Lock Bits
    - In-System Programming by On-chip Boot Program
    - True Read-While-Write Operation
    - Programming Lock for Software Security
  - JTAG (IEEE std. 1149.1 Compliant) Interface
    - Boundary-scan Capabilities According to the JTAG Standard
    - Extensive On-chip Debug Support
    - Programming of Flash, EEPROM, Fuses, and Lock Bits through the JTAG Interface
  - Peripheral Features
    - Two 8-bit Timer/Counters with Separate Prescalers and Compare Modes
    - One 16-bit Timer/Counter with Separate Prescaler, Compare Mode, and Capture Mode
    - Real Time Counter with Separate Oscillator
    - Four PWM Channels
    - 8-channel, 10-bit ADC
      - 8 Single-ended Channels
      - 7 Differential Channels in TQFP Package Only
      - 2 Differential Channels with Programmable Gain at 1x, 10x, or 200x
    - Byte-oriented Two-wire Serial Interface
    - Programmable Serial USART

- Master/Slave SPI Serial Interface
  - Programmable Watchdog Timer with Separate On-chip Oscillator
  - On-chip Analog Comparator
- Special Microcontroller Features
  - Power-on Reset and Programmable Brown-out Detection
  - Internal Calibrated RC Oscillator
  - External and Internal Interrupt Sources
  - Six Sleep Modes: Idle, ADC Noise Reduction, Power-save, Power-down, Standby and Extended Standby
- 32 Programmable I/O Lines
- Operating Voltages
  - 2.7 - 5.5V
- Speed Grades
  - 0 - 8 MHz

# BLOCK DIAGRAM

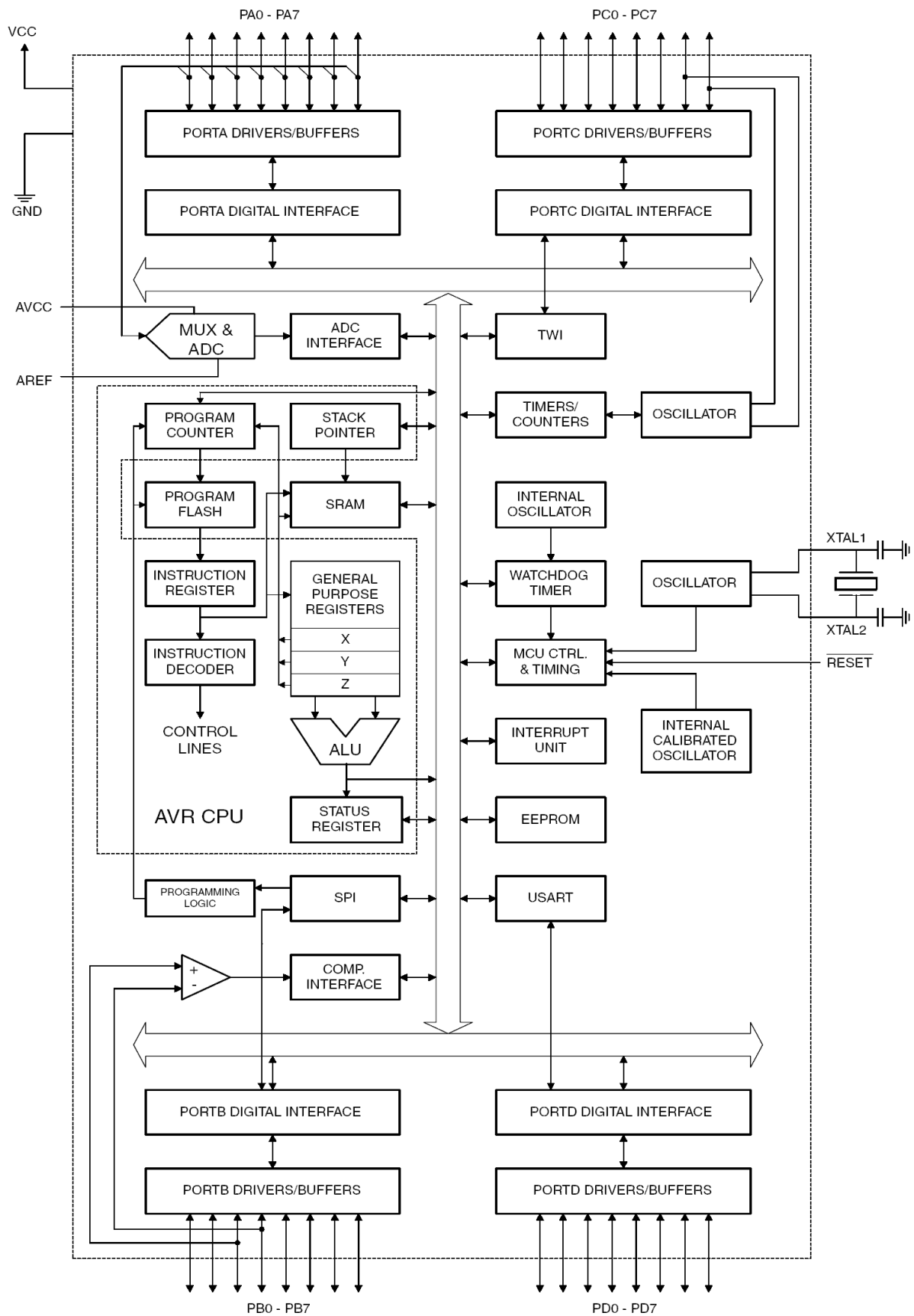

MEMORY MAP:

# Program Memory Map

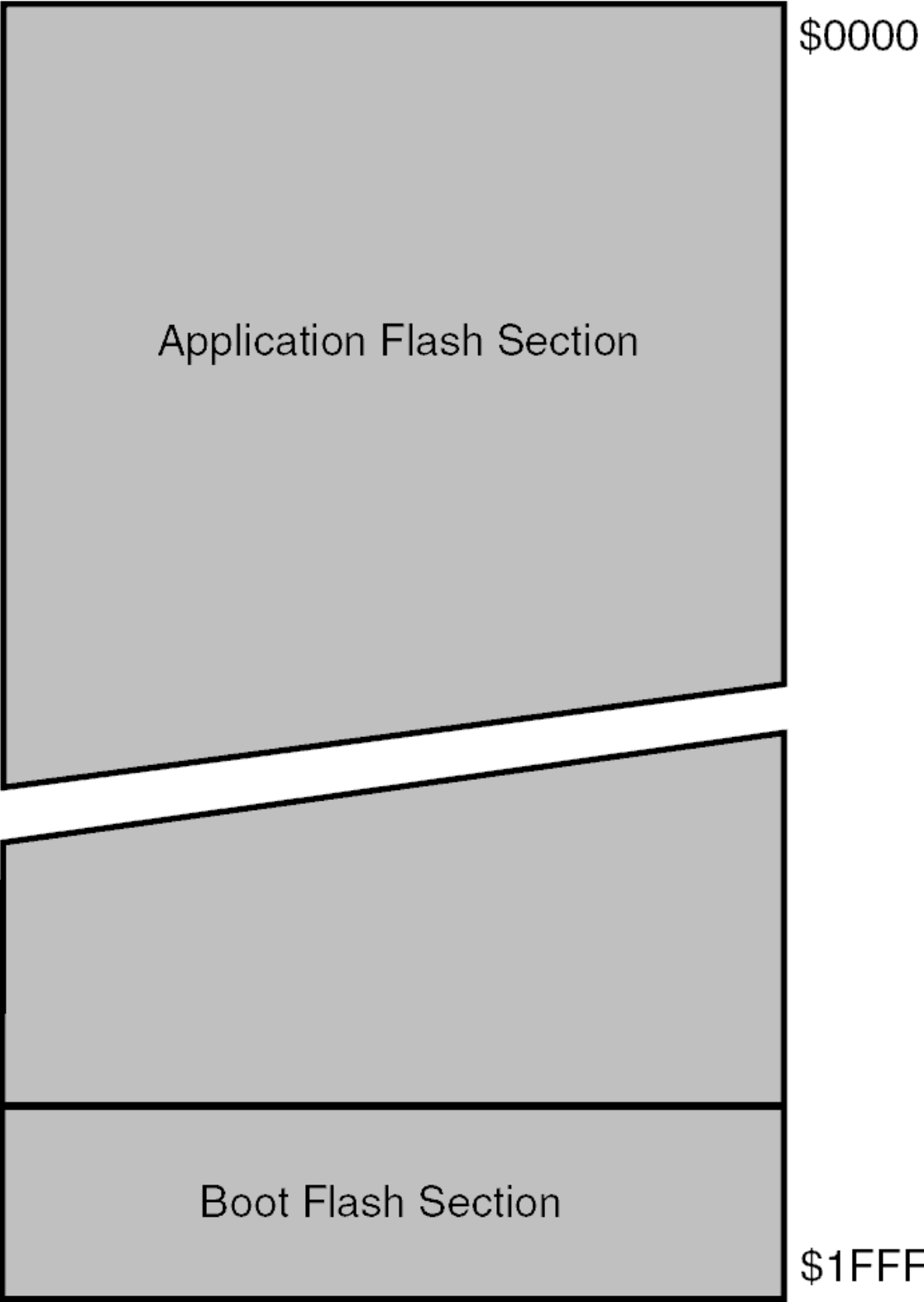

# Data Memory Map

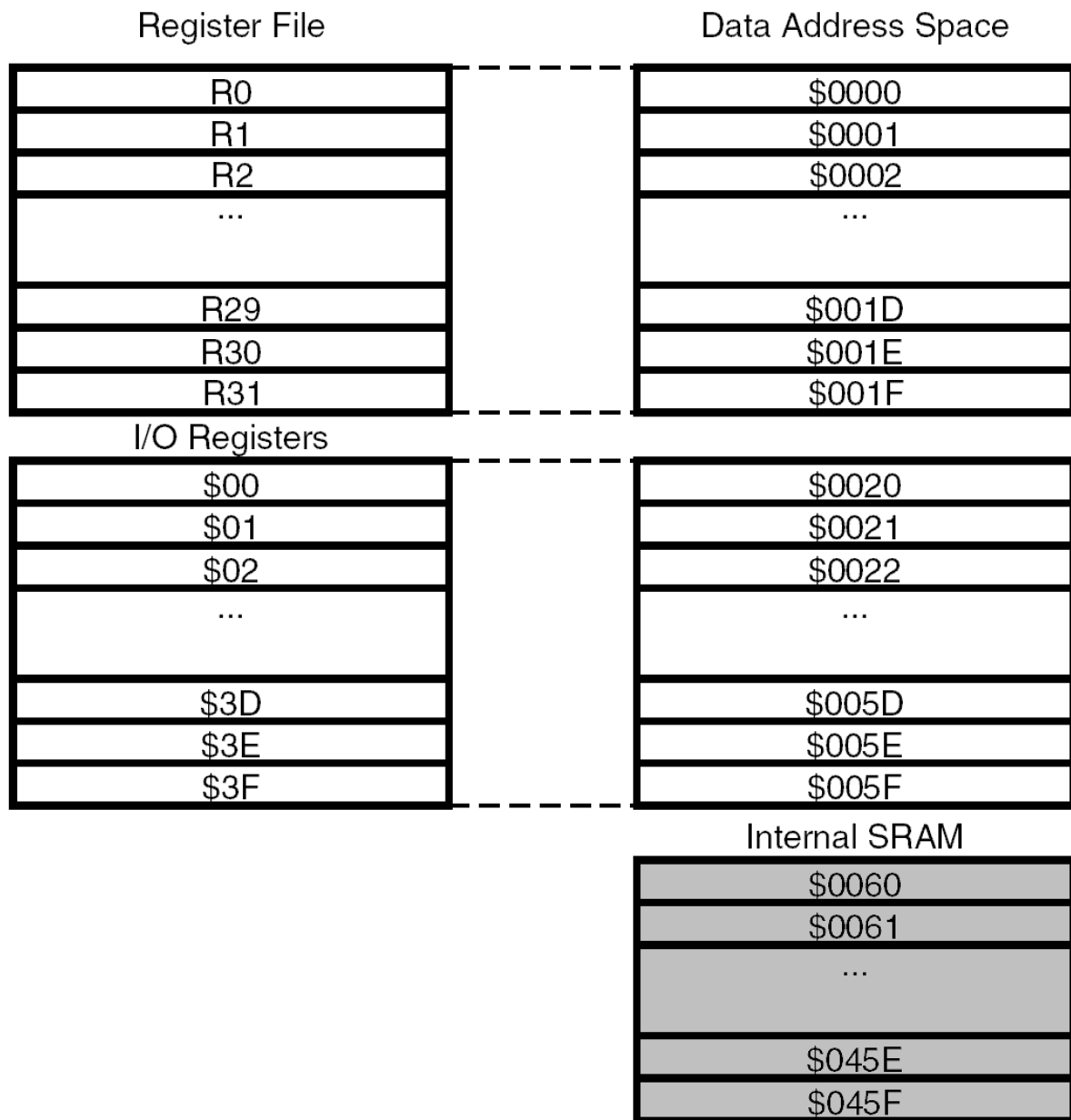

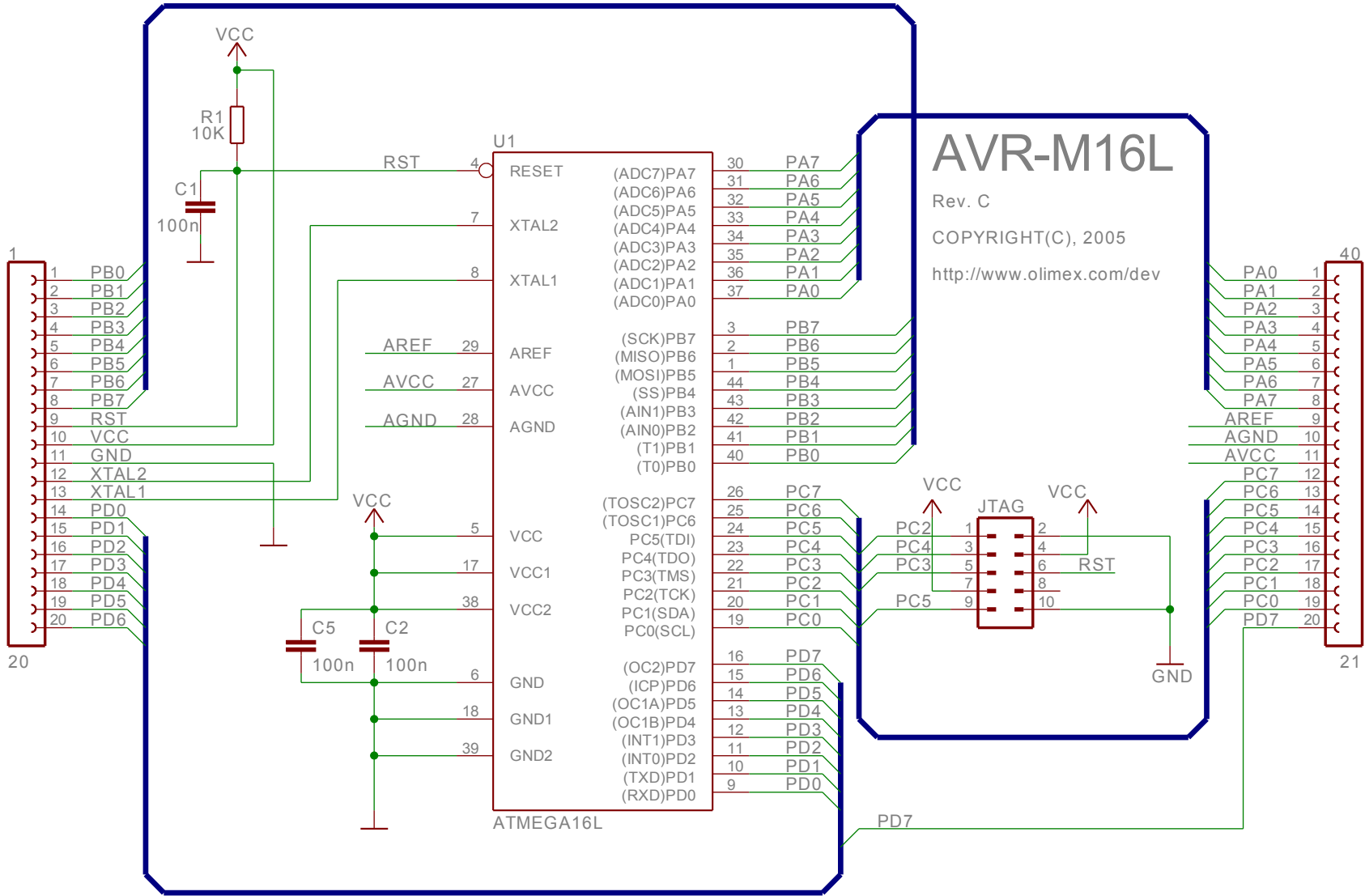



## BOARD LAYOUT

### **Header (21-40)**



### **Header (1-20)**

## POWER SUPPLY CIRCUIT

The board is power supplied from header connector (1-20) pin 10 and pin 11 with 3.3 V DC.

## RESET CIRCUIT

AVR-M16L reset circuit is made with RC group (R1 and C1) and includes pin 6 of JTAG connector, pin 9 of header connector (1-20), and ATmega16L pin 4.

## JUMPER DESCRIPTION

There are no jumpers on this board.

## CONNECTOR DESCRIPTIONS

### JTAG

Pin #	Signal Name
1	PC2
2	GND
3	PC4
4	+3.3V
5	PC3
6	RST
7	+3.3V
8	NC
9	PC5
10	GND

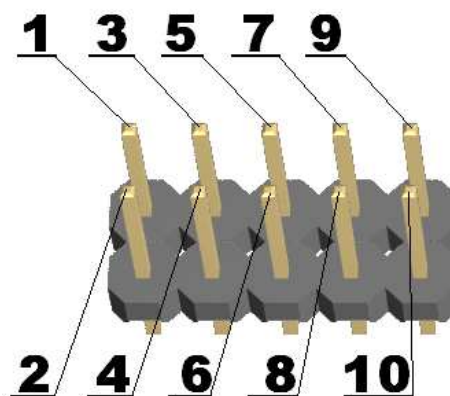

## HEADER CONNECTOR (1-20)

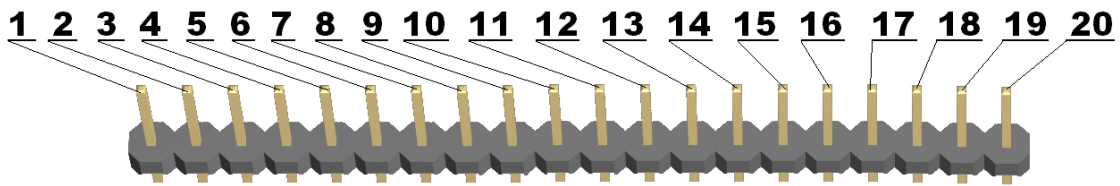

Pin #	Signal Name	Pin #	Signal Name
1	PB0	2	PB1
3	PB2	4	PB3
5	PB4	6	PB5
7	PB6	8	PB7
9	RST	10	+3.3V
11	GND	12	XTAL2
13	XTAL1	14	PD0
15	PD1	16	PD2
17	PD3	18	PD4
19	PD5	20	PD6

## HEADER CONNECTOR (21-40)

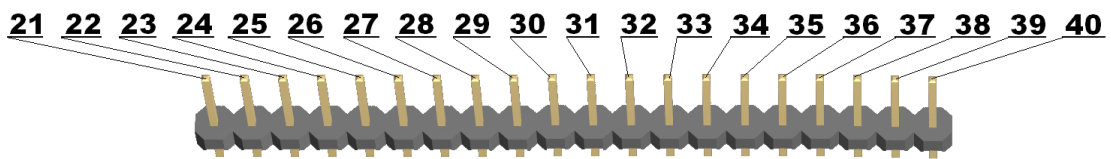

Pin #	Signal Name	Pin #	Signal Name
21	PD7	22	PC0
23	PC1	24	PC2
25	PC3	26	PC4
27	PC5	28	PC6
29	PC7	30	AVCC
31	AGND	32	AREF
33	PA7	34	PA6
35	PA5	36	PA4
37	PA3	38	PA2
39	PA1	40	PA0

MECHANICAL DIMENSIONS

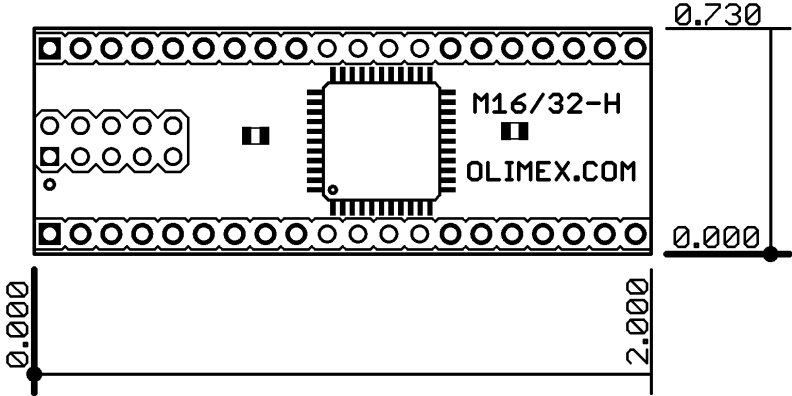

All measures are in Inches.

**AVAILABLE DEMO SOFTWARE**

n. a.

## **ORDER CODE**

**AVR-M16L** - Fully assembled and tested with ATMega16L-08AC microcontroller

How to order?

You can order to us directly or by any of our distributors.

Check our web [www.olimex.com/dev](http://www.olimex.com/dev) for more info.

### **Revision history:**

REV. C            - create   January 2005

**Disclaimer:**

© 2009 Olimex Ltd. All rights reserved. Olimex®, logo and combinations thereof, are registered trademarks of Olimex Ltd. Other terms and product names may be trademarks of others.

The information in this document is provided in connection with Olimex products. No license, express or implied or otherwise, to any intellectual property right is granted by this document or in connection with the sale of Olimex products.

Neither the whole nor any part of the information contained in or the product described in this document may be adapted or reproduced in any material from except with the prior written permission of the copyright holder.

The product described in this document is subject to continuous development and improvements. All particulars of the product and its use contained in this document are given by OLIMEX in good faith. However all warranties implied or expressed including but not limited to implied warranties of merchantability or fitness for purpose are excluded.

This document is intended only to assist the reader in the use of the product. OLIMEX Ltd. shall not be liable for any loss or damage arising from the use of any information in this document or any error or omission in such information or any incorrect use of the product.