

MSP430-5438STK development board Users Manual



All boards produced by Olimex are ROHS compliant

Rev.A, October 2009
Copyright(c) 2009, OLIMEX Ltd, All rights reserved

INTRODUCTION

MSP430-5438STK development board provides easy way for developing and prototyping with MSP430F5438 mixed signal microcontroller produced by Texas Instruments.

This powerful microcontroller supports various serial interfaces such as USB Device, UART, SPI. In addition you will find also audio input and output, debug interface, LCD, UEXT, two Extensions, mini SD/MMC, User Joystick, User Leds, Reset button. All this allows you to build a diversity of powerful applications to be used in a wide range of situations.

BOARD FEATURES

- CPU: MSP430F5438 mixed signal microcontroller
- LCD NOKIA 3310 black/white 84x48 pixels
- JTAG connector
- JTAG Power_In and Power_Out jumpers
- Two extension connectors
- UEXT connector
- RS232 driver and connector
- Power plug-in jack for 9V DC power supply
- Voltage regulator +3.3V - VR1(3.3V)
- 2 status LEDs
- Power on Led
- Audio In
- Audio Out
- SD/MMC mini connector
- USB device connector
- Reset button
- User joystick
- PCB: FR-4, 1.5 mm (0,062"), solder mask, silkscreen component print
- Dimensions: 100x 98mm (3.94x 3.85")

ELECTROSTATIC WARNING

The MSP430-5438STK board is shipped in protective anti-static packaging. The board must not be subject to high electrostatic potentials. General practice for working with static sensitive devices should be applied when working with this board.

BOARD USE REQUIREMENTS

Cables: The cable you will need depends on the programmer/debugger you use. If you use MSP430-JTAG, you will need LPT cable, if you use MSP430-JTAG-TINY or MSP-JTAG-ISO, you will need 1.8m A-B USB cable, if you use MSP430-JTAG-RF, you can connect it to the USB port of your computer, or via USB cable type A - female.

Hardware: Programmer/Debugger - one of our Programmers - [MSP430-JTAG](#), [MSP430-JTAG-TINY](#), [MSP430-JTAG-ISO](#), or [MSP430-JTAG-RF](#).

Software: MSP430 KickStart software.

PROCESSOR FEATURES

MSP430-5438STK board use ultralow-power consumption mixed signal microcontroller with these features:

- 256KB+512B Flash Memory
- 16KB RAM
- Four Universal Serial Communication Interfaces
- Low Supply Voltage Range
 - 1.8 V to 3.6 V
- Ultralow Power Consumption
 - Active Mode (AM): 165 mA/MHz at 8 MHz
 - Standby Mode (LPM3 RTC Mode): 2.60 mA
 - Off Mode (LPM4 RAM Retention): 1.69 mA
 - Shutdown Mode (LPM5): 0.1 mA
- Wake-Up From Standby Mode in Less Than 5 ms
- 16-Bit RISC Architecture
 - Extended Memory
 - 18-MHz System Clock
- Flexible Power Management System

- Fully Integrated LDO With Programmable Regulated Core Supply Voltage
 - Supply Voltage Supervision, Monitoring, and Brownout
- Unified Clock System
 - FLL Control Loop for Frequency Stabilization
 - Low-Power/Low-Frequency Internal Clock Source (VLO)
 - Low-Frequency Trimmed Internal Reference Source (REFO)
 - 32-kHz Crystals
 - High-Frequency Crystals up to 32 MHz
- 16-Bit Timer TA0, Timer_A With Five Capture/Compare Registers
- 16-Bit Timer TA1, Timer_A With Three Capture/Compare Registers
- 16-Bit Timer TB0, Timer_B With Seven Capture/Compare Shadow Registers
- Up to Four Universal Serial Communication Interfaces
 - Enhanced UART Supporting Auto-Baudrate Detection
 - IrDA Encoder and Decoder
 - Synchronous SPI
 - I2C™
- 12-Bit Analog-to-Digital (A/D) Converter
 - Internal Reference
 - Sample-and-Hold
 - Autoscan Feature
 - 12 External Channels, 4 Internal Channels
- Hardware Multiplier Supporting 32-Bit Operations
- Serial Onboard Programming, No External Programming Voltage Needed
- Three Channel Internal DMA
- Basic Timer With Real-Time Clock Feature

BLOCK DIAGRAM

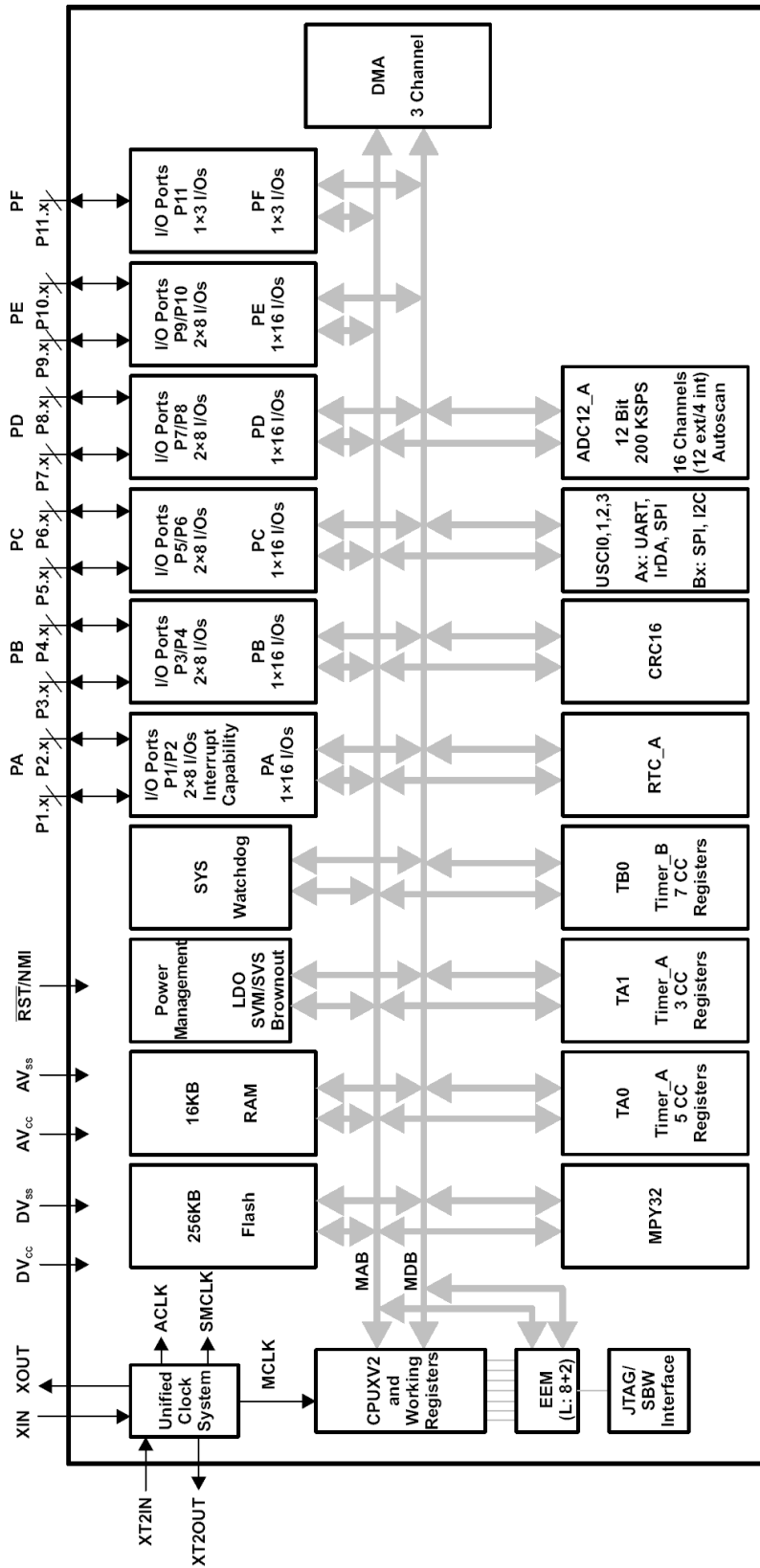

MEMORY ORGANIZATION

		MSP430F5438
Memory (flash) Main: interrupt vector Main: code memory	Total Size Flash Flash	256 KB 00FFFFh–00FF80h 045BFFh–005C00h
Main: code memory	Bank 3	64 KB 03FFFFh–030000h
	Bank 2	64 KB 02FFFFh–020000h
	Bank 1	64 KB 01FFFFh–010000h
	Bank 0	64 KB 045BFFh–040000h 00FFFFh–005C00h
RAM	Size	16 KB
	Sector 3	4 KB 005BFFh–004C00h
	Sector 2	4 KB 004BFFh–003C00h
	Sector 1	4 KB 003BFFh–002C00h
	Sector 0	4 KB 002BFFh–001C00h
Information memory (Flash)	Info A	128 B 0019FFh–001980h
	Info B	128 B 00197Fh–001900h
	Info C	128 B 0018FFh–001880h
	Info D	128 B 00187Fh–001800h
Bootstrap loader (BSL) memory (Flash)	BSL 3	512 B 0017FFh–001600h
	BSL 2	512 B 0015FFh–001400h
	BSL 1	512 B 0013FFh–001200h
	BSL 0	512 B 0011FFh–001000h
Peripherals	Size	4KB 000FFFh–000000h

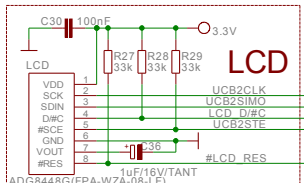
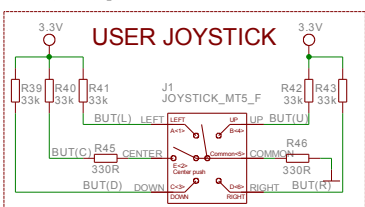
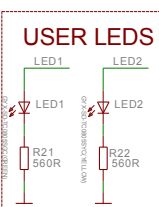
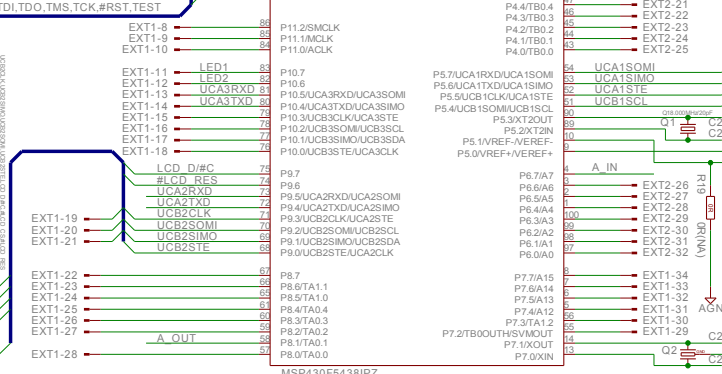
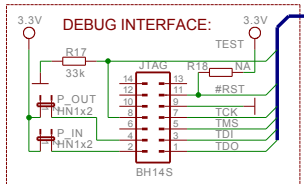
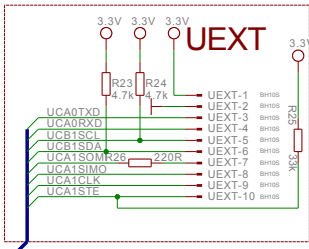
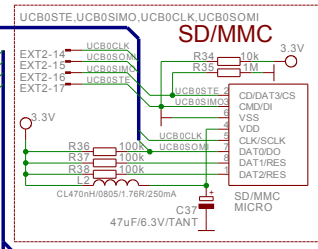
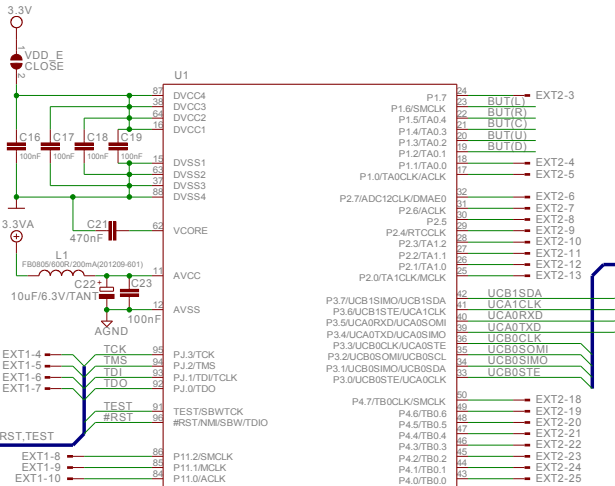
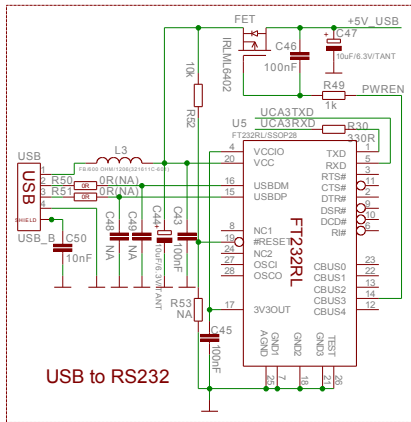
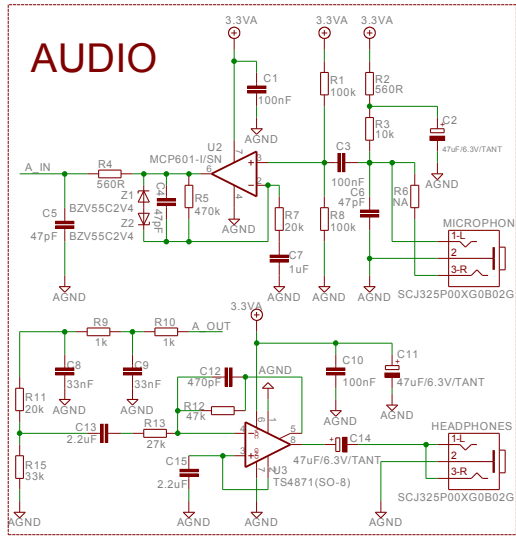
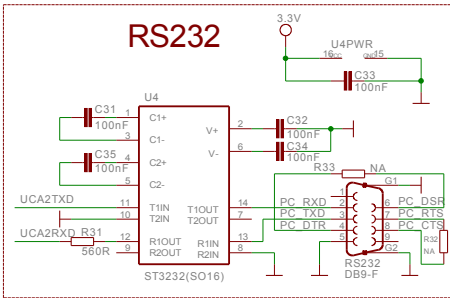
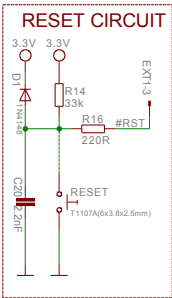
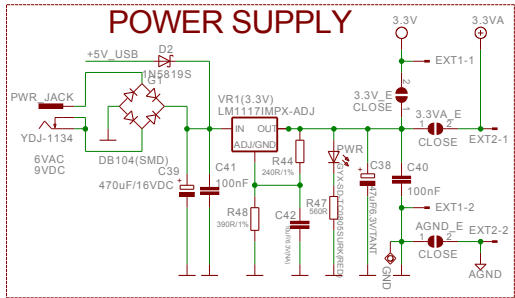

MSP430-5438STK
Rev. A
COPYRIGHT(C), 2009
http://www.olimex.com/dev

BOARD LAYOUT

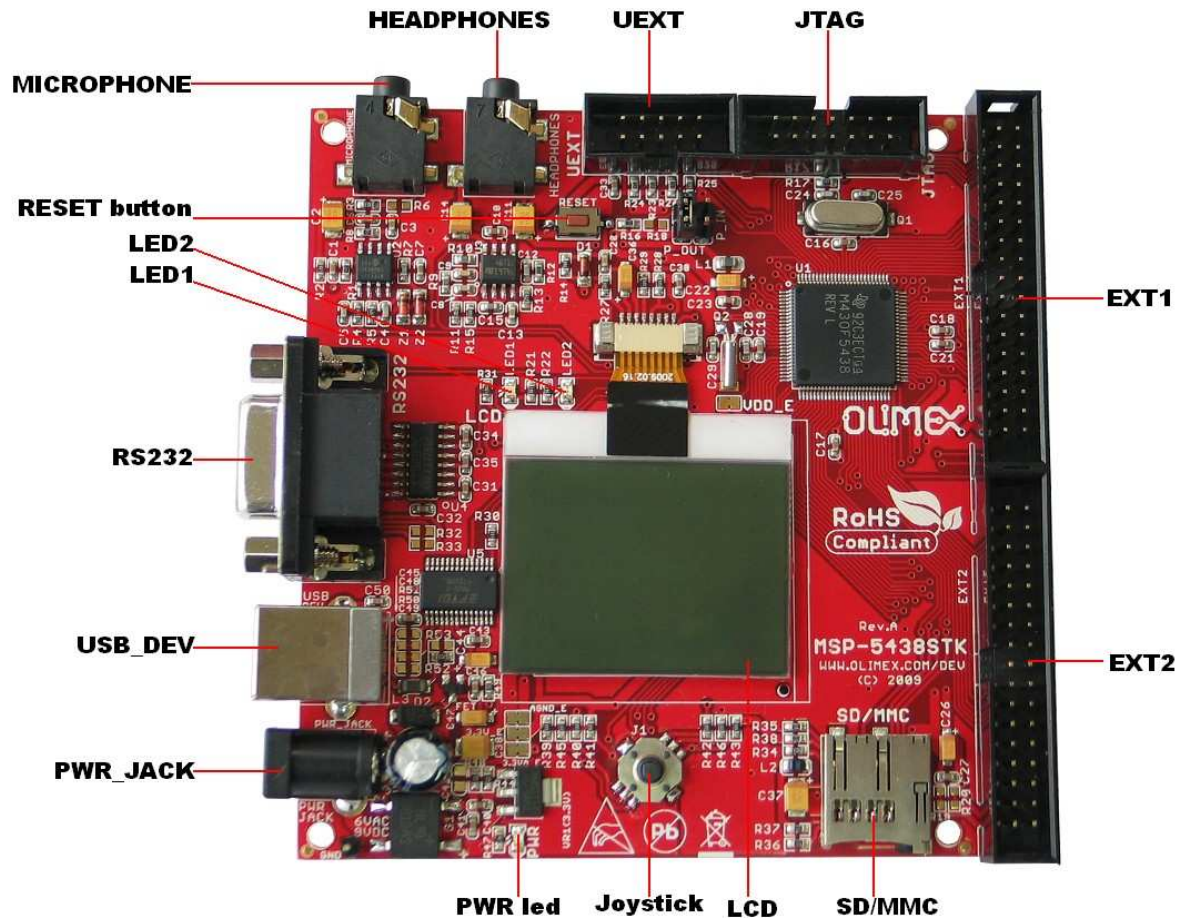

POWER SUPPLY CIRCUIT

MSP430-5438STK can take power from three sources:

- PWR connector where 9 V DC or 6 V AC is applied by external power source.
- +5V_USB from USB DEV
- JTAG, when P_IN jumper is closed. Note that the JTAG has current limitations.

The board power consumption is: about 20 mA with all peripherals and microcontroller running at full speed.

RESET CIRCUIT

MSP430-5438STK reset circuit includes JTAG connector pin 11, EXT1 pin 3, MSP430F5438 pin 96 and Reset button.

CLOCK CIRCUIT

Quartz crystal 32768 MHz is connected to MSP430F5438 pin 13(P7.0/XIN) and pin 14 (P7.1/XOUT).

Quartz crystal 18 MHz is connected to MSP430F5438 pin 89 (P5.2/XT2IN) and pin 90 (P5.3/XT2OUT).

JUMPER DESCRIPTION

Power In jumper:

P_IN jumper connects power supply from JTAG connector. You have to ensure that your circuit doesn't draw more than few milliampers current or the power supply may decrease due to the JTAG port current limitations. P_IN is useful and must be used mostly to program the microcontroller.

Power Out jumper:

P_OUT jumper connects power from MSP430-5438STK to JTAG connector. When this jumper cap is placed, the power supply of JTAG connector will follow the power supply of the board. This is useful when your board works at lower than +3,3V power supply.

Note:

P_IN and **P_OUT** jumper caps should not be placed at the same time.

VDD_E



Enable MSP430F5438 3.3 V power supply.

Default state is closed.

3.3V_E



Enable 3.3V board power supply.

Default state is closed.

3.3VA_E



Enable 3.3V board analog power supply.

Default state is closed.

AGND_E



Enable board analog ground.

Default state is closed.

Input/Output

User joystick with name **J1** – this is 4 directions plus center button, in the schematic the joystick four directions switches are connected: UP, DOWN, LEFT, RIGHT - through 33k resistors and CENTER through serial connected 330 and 33k resistors to 3.3V.

Status LED (green) with name **LED1** connected to MSP430F5438 pin 83 (P10.7).

Status LED (yellow) with name **LED2** connected to MSP430F5438 pin 82 (P10.6).

Power supply LED (red) with name **PWR** – indicates that external power source is applied and board power supply is applied.

Reset button with name **RESET**, connected to MSP430F5438 pin 96.

LCD black/white 84x48 pixels

CONNECTOR DESCRIPTIONS

JTAG

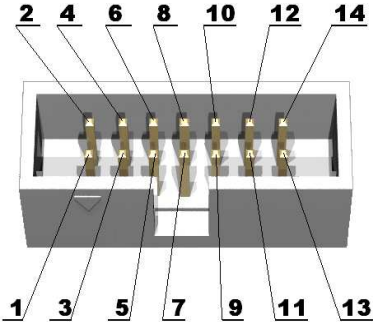

Pin #	Signal Name	Pin #	Signal Name
1	TDO	2	VCC_IN
3	TDI	4	VCC_OUT
5	TMS	6	NC
7	TCK	8	TEST
9	GND	10	NC
11	#RST	12	NC
13	NC	14	NC

RS232

Pin #	Signal Name
1	NC
2	PC_RXD
3	PC_TXD
4	PC_DTR
5	GND
6	PC_DSR
7	PC_RTS
8	PC_CTS
9	NC

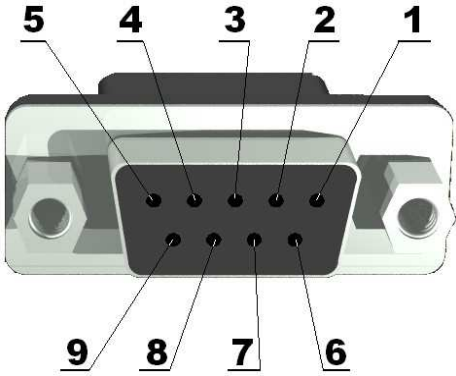

USB DEV

Pin #	Signal Name
1	+5V_USB
2	USBDM
3	USBDP
4	GND

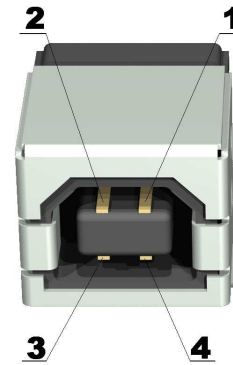

PWR JACK

Pin #	Signal Name
1	Power Input
2	GND

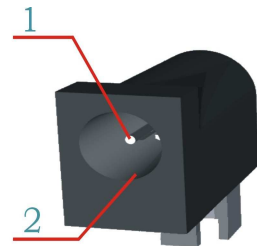

UEXT

Pin #	Signal Name
1	3.3V
2	GND
3	UCA0TXD
4	UCA0RXD
5	UCB1SCL
6	UCB1SDA
7	UCA1SOMI
8	UCA1SIMO
9	UCA1CLK
10	UCA1STE

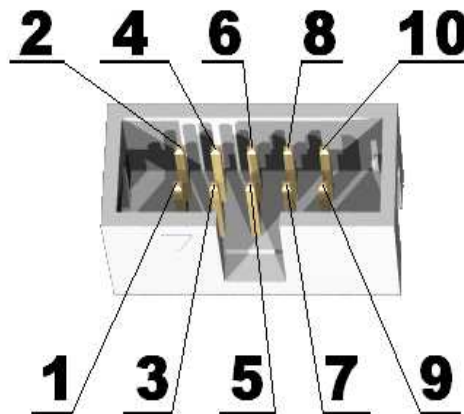

EXT1

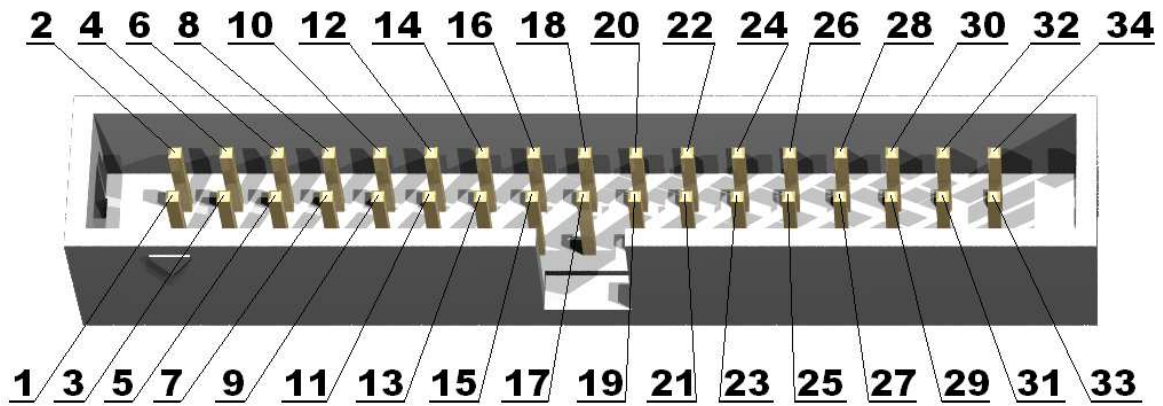

Pin #	Signal Name	Pin #	Signal Name
1	3.3V	2	GND
3	#RST	4	TCK
5	TMS	6	TDI
7	TDO	8	P11.2
9	P11.1	10	P11.0
11	LED1	12	LED2
13	UCA3RXD	14	UCA3TXD
15	P10.3	16	P10.2
17	P10.1	18	P10.0
19	UCB2CLK	20	UCB2SOMI
21	UCB2SIMO	22	P8.7
23	P8.6	24	P8.5
25	P8.4	26	P8.3
27	P8.2	28	P8.0
29	P7.2	30	P7.3
31	P7.4	32	P7.5
33	P7.6	34	P7.7

EXT2

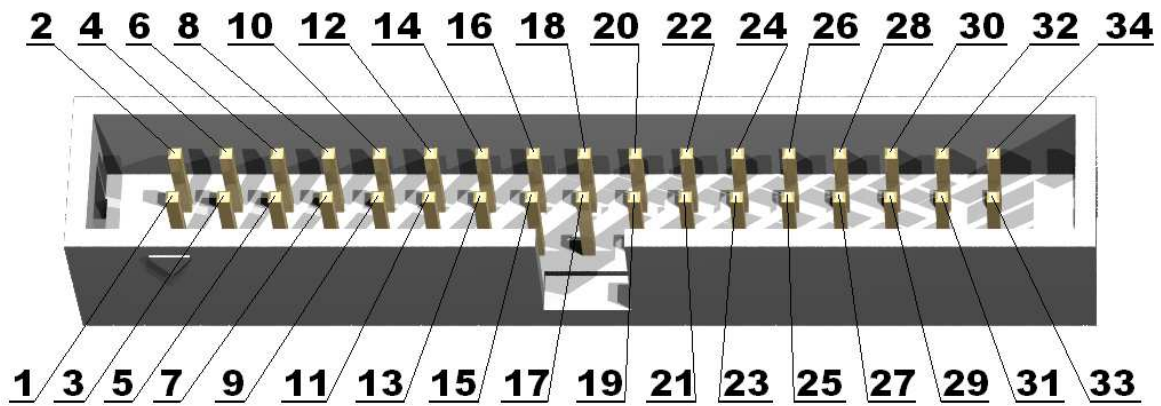

Pin #	Signal Name	Pin #	Signal Name
1	3.3VA	2	AGND
3	P1.7	4	P1.1
5	P1.0	6	P2.7
7	P2.6	8	P2.5
9	P2.4	10	P2.3
11	P2.2	12	P2.1
13	P2.0	14	UCB0CLK
15	UCB0SOMI	16	UCB0SIMO
17	UCB0STE	18	P4.7
19	P4.6	20	P4.5
21	P4.4	22	P4.3
23	P4.2	24	P4.1
25	P4.0	26	P6.6
27	P6.5	28	P6.4
29	P6.3	30	P6.2
31	P6.1	32	P6.0
33	P5.0	34	P5.1

SD/MMC

Pin #	Signal Name
1	Pull-up
2	UCB0STE
3	UCB0SIMO
4	VDD (power supply)
5	UCB0CLK
6	GND
7	UCB0SOMI
8	Pull-up
9	Not connected
10	Not connected
11	Not connected
12	Not connected

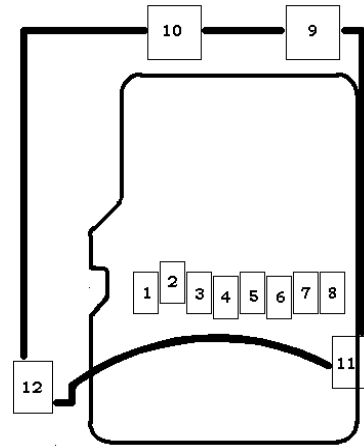

Microphone

Pin #	Signal Name
1	AGND
2	NC
3	MIC

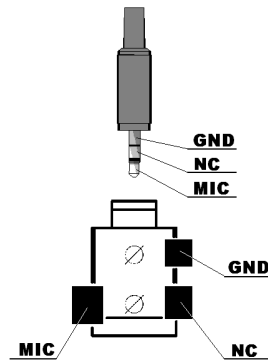

Headphone

Pin #	Signal Name
1	AGND
2	IN1=IN2
3	IN2=IN1

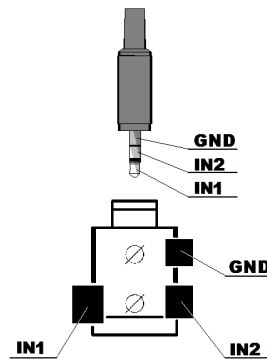

MECHANICAL DIMENSIONS

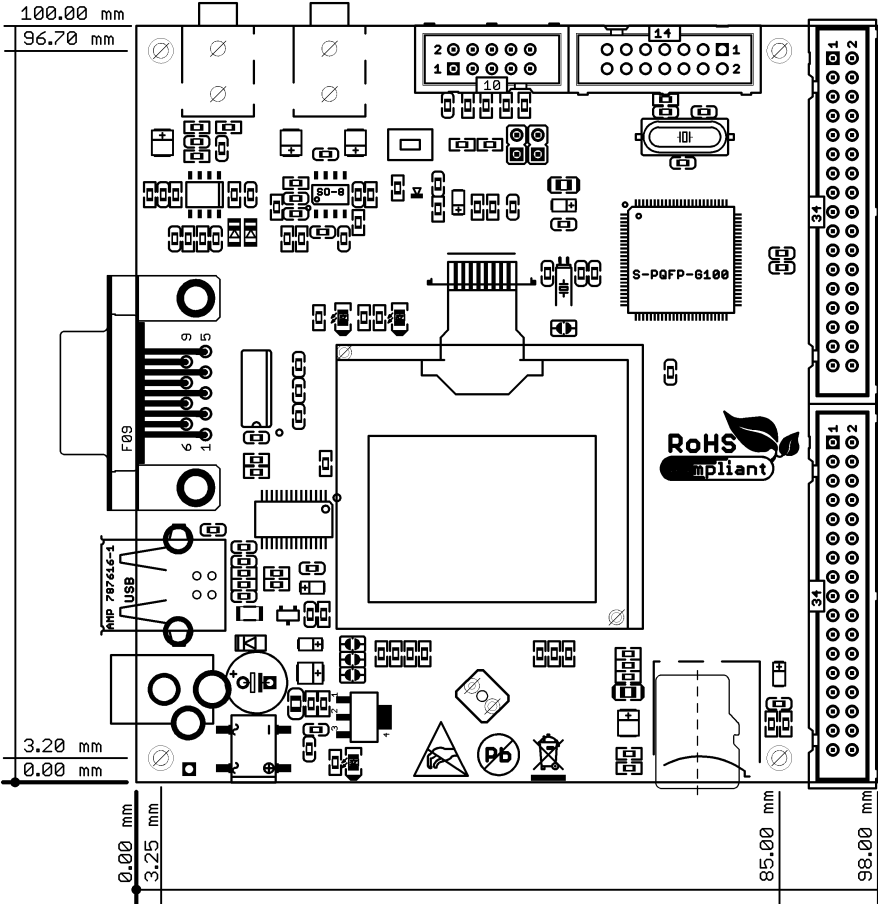

AVAILABLE DEMO SOFTWARE

- Display demo
- LEDs and Buttons demo
- SD/MMC demo
- UART demo
- USB UART demo
- ADC and DAC demo

ORDER CODE

MSP430-5438STK – assembled and tested (no kit, no soldering required)

How to order?

You can order to us directly or by any of our distributors.

Check our web www.olimex.com/dev for more info.

Revision history:

REV.A - October 2009

Initial release

REV. B - March 2012

Changes:

Page 13 - Changed wrong signal names in the table with the correct ones (signals #14,15,16,17)

Disclaimer

© 2009 Olimex Ltd. All rights reserved. Olimex®, logo and combinations thereof, are registered trademarks of Olimex Ltd. Other terms and product names may be trademarks of others.

The information in this document is provided in connection with Olimex products. No license, express or implied or otherwise, to any intellectual property right is granted by this document or in connection with the sale of Olimex products.

Neither the whole nor any part of the information contained in or the product described in this document may be adapted or reproduced in any material from except with the prior written permission of the copyright holder.

The product described in this document is subject to continuous development and improvements. All particulars of the product and its use contained in this document are given by OLIMEX in good faith. However all warranties implied or expressed including but not limited to implied warranties of merchantability or fitness for purpose are excluded.

This document is intended only to assist the reader in the use of the product. OLIMEX Ltd. shall not be liable for any loss or damage arising from the use of any information in this document or any error or omission in such information or any incorrect use of the product.