

MSP430-H123 HEADER BOARD FOR MSP430F123 MICROCONTROLLERS

Features:

The MSP430-H123 header board provides easy way for developing and prototyping with MSP430F123 microcontrollers. The board is with following features:

- JTAG connector
- JTAG Power_In and Power_Out jumpers
- 32768 Hz crystal oscillator
- TEST pin pull-down
- RST/NMI pin pull-up
- Power supply filter capacitors
- 0.1" (2.54 mm) extension slots

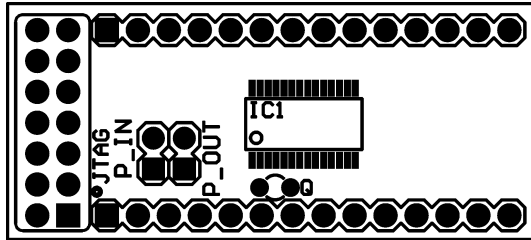

Power In jumper:

Power_In jumper connects power supply from JTAG connector to Header board. When this jumper cap is placed you can program the microcontroller even without any other external supply. Note that if the Header board is placed in target circuit, you have to ensure that your circuit doesn't draw more than few milliampers current or the power supply may decrease due to the JTAG port current limitations. Power_In is useful and must be used mostly to program your header board when it's not put on your target circuit socket.

Power Out jumper:

Power_Out jumper connects power from Header board to JTAG connector. When this jumper cap is placed, the power supply of JTAG connector

will follow the power supply of Header board. This is useful when your Header board (target circuit) works at lower than +3,3V power supply.

Note:

Power_In and **Power_Out** jumper caps should not be placed at the same time.

Programming:

To program MSP430-H123 you need MSP430 JTAG dongle (Olimex part # MSP430-JTAG) and MSP430 KickStart software. KickStart allow you to write and debug code in assembly language without any limitations and to write code in C with 2K limit. The latest release of KickStart software may be free download from TI web site: <http://www.ti.com/sc/msp430>

JTAG interface:

The JTAG connector is 2x7 pin with 0,1" step and TI recommended JTAG layout. The PIN.1 is marked with square pad on bottom and arrow on top. JTAG signals are on port P1.4, P1.5, P1.6 and P1.7, which are not used for other functions.

JTAG TOP view PCB board layout:

MSP430-JTAG			
TDO	1	2	VCC_IN
TDI	3	4	VCC_OUT
TMS	5	6	NC
TCK	7	8	TEST/UPP
GND	9	10	NC
RST/NMI	11	12	NC
NC	13	14	NC

Ordering codes:

MSP430-H123 - assembled and tested

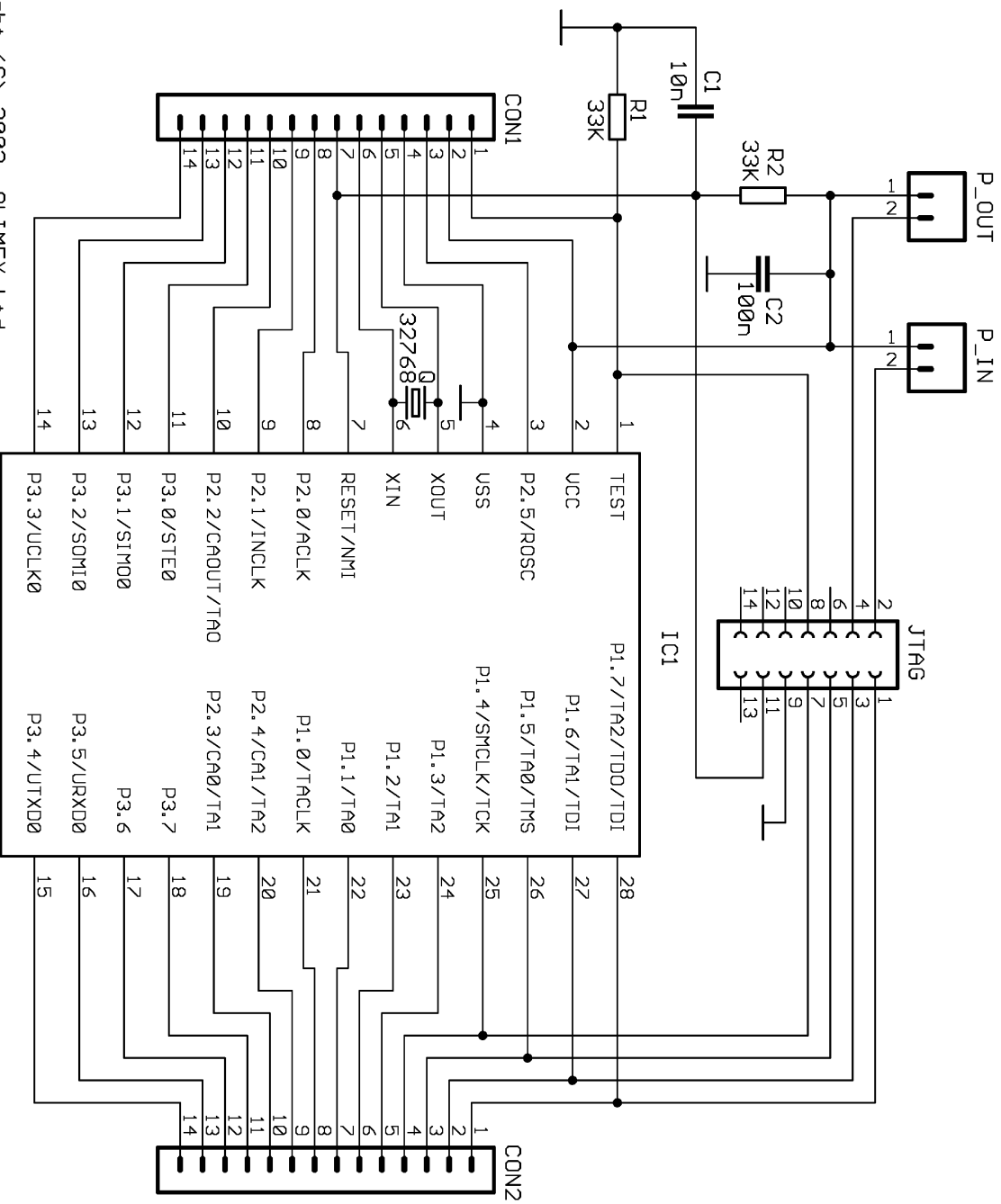

Copyright (C) 2002, OLIMEX Ltd
<http://www.olimex.com/dev>

MSP430F123