

MOD-IO development board user's manual



All boards produced by Olimex are ROHS compliant
Rev. C, March 2013

Copyright(c) 2011, OLIMEX Ltd, All rights reserved

INTRODUCTION

MOD-IO is a small but powerful development board who let you control 4 optoisolated input and 4 relay outputs - with this features is possible to turn on and off almost any electronic device at home. The board has UEXT_FEMALE connector which allows you to communicate with a PC and UEXT_MALE connector where you can connect other Olimex board with UEXT.

The MOD-IO project is fully open software and open hardware. The customer has full access to the documentation of the board including schematics and board design.

The main idea of MOD-IO chain connection is to extend:

- isolated relay outputs
- isolated digit inputs
- non isolated analog inputs
- non isolated digit inputs/outputs

using UEXT male/female connector. So the MCU interfaces (I2C, SPI, UART) from all chain boards are connected in parallel.

Note that if you want to connect more than 1 MOD-IO board then on the interface bus (I2C or UART or SPI) has to have only one Master device. The other devices have to be Slaves.

For example: if UART interface is used - the master will send a string with Slave address and command. All Slaves will listen UART bus through RXD line while all Slave TXD lines are inputs. So when the address is recognized from the Slave device, the one will answer as it will force TXD pin like output but immediately after command answer is finished the Slave TXD pin must be initialized like input.

The same principle can be used for other interfaces (SPI or I2C).

BOARD FEATURES

- Microcontroller: Atmega16L
- AVRISP connector
- JTAG connector
- EXT connector
- UEXT_MALE
- UEXT_FEMALE
- Clock circuit
- User button
- Reset circuit and button
- Power Jack
- Power-on led
- Nine status leds
- Four optocoupler isolated inputs

- Four Relays
- PCB: FR-4, 1.5 mm (0,062"), solder mask, silkscreen component print
- Dimensions: 100x80 mm (3.94x3.15")

ELECTROSTATIC WARNING

The MOD-IO board is shipped in protective anti-static packaging. The board must not be subject to high electrostatic potentials. General practice for working with static sensitive devices should be applied when working with this board.

BOARD USE REQUIREMENTS

- Cables:** The cable you will need depends on the programmer/debugger you use. If you use AVR-PG1, or AVR-JTAG, you will need RS232 cable, if you use AVR-PG2, you will need LPT cable, if you use AVR-USB-JTAG, AVR-ISP500, AVR-ISP500-TINY, AVR-ISP500-ISO, AVR-ISP-MK2 you will need 1.8 meter A-B USB cable.
- Hardware:** One of Olimex programmers/debuggers – [AVR-PG1](#), [AVR-PG2](#), [AVR-ISP500](#), [AVR-ISP500-TINY](#), [AVR-ISP500-ISO](#), [AVR-JTAG](#), [AVR-USB-JTAG](#), [AVR-ISP-MK2](#) or other compatible programming/debugging tool.
Make sure to check if the above programmer/debugger is supported by the IDE you are going to use.
- Software:** AVR C Compiler

PROCESSOR FEATURES

MOD-IO use 8-bit AVR Microcontroller with 16K Bytes In-System Programmable Flash, with these features:

- High-performance, Low-power AVR[®] 8-bit Microcontroller
 - Advanced RISC Architecture
 - 131 Powerful Instructions – Most Single-clock Cycle Execution
 - 32 x 8 General Purpose Working Registers
 - Fully Static Operation
 - Up to 16 MIPS Throughput at 16 MHz
 - On-chip 2-cycle Multiplier
 - High Endurance Non-volatile Memory segments
 - 16K Bytes of In-System Self-programmable Flash program memory
 - 512 Bytes EEPROM
 - 1K Byte Internal SRAM
 - Write/Erase Cycles: 10,000 Flash/100,000 EEPROM
 - Data retention: 20 years at 85°C/100 years at 25°C
 - Optional Boot Code Section with Independent Lock Bits
- In-System Programming by On-chip Boot Program
True Read-While-Write Operation

- Programming Lock for Software Security
- JTAG (IEEE std. 1149.1 Compliant) Interface
 - Boundary-scan Capabilities According to the JTAG Standard
 - Extensive On-chip Debug Support
 - Programming of Flash, EEPROM, Fuses, and Lock Bits through the JTAG Interface
- Peripheral Features
 - Two 8-bit Timer/Counters with Separate Prescalers and Compare Modes
 - One 16-bit Timer/Counter with Separate Prescaler, Compare Mode, and Capture Mode
 - Real Time Counter with Separate Oscillator
 - Four PWM Channels
 - 8-channel, 10-bit ADC
 - 8 Single-ended Channels
 - 7 Differential Channels in TQFP Package Only
 - 2 Differential Channels with Programmable Gain at 1x, 10x, or 200x
 - Byte-oriented Two-wire Serial Interface
 - Programmable Serial USART
 - Master/Slave SPI Serial Interface
 - Programmable Watchdog Timer with Separate On-chip Oscillator
 - On-chip Analog Comparator
- Special Microcontroller Features
 - Power-on Reset and Programmable Brown-out Detection
 - Internal Calibrated RC Oscillator
 - External and Internal Interrupt Sources
 - Six Sleep Modes: Idle, ADC Noise Reduction, Power-save, Power-down, Standby and Extended Standby
- I/O and Packages
 - 32 Programmable I/O Lines
- Operating Voltages
 - 2.7 - 5.5V
- Speed Grades
 - 0 - 8 MHz
- Power Consumption @ 1 MHz, 3V, and 25°C
 - Active: 1.1 mA

- Idle Mode: 0.35 mA
- Power-down Mode: $< 1 \mu\text{A}$

BLOCK DIAGRAM

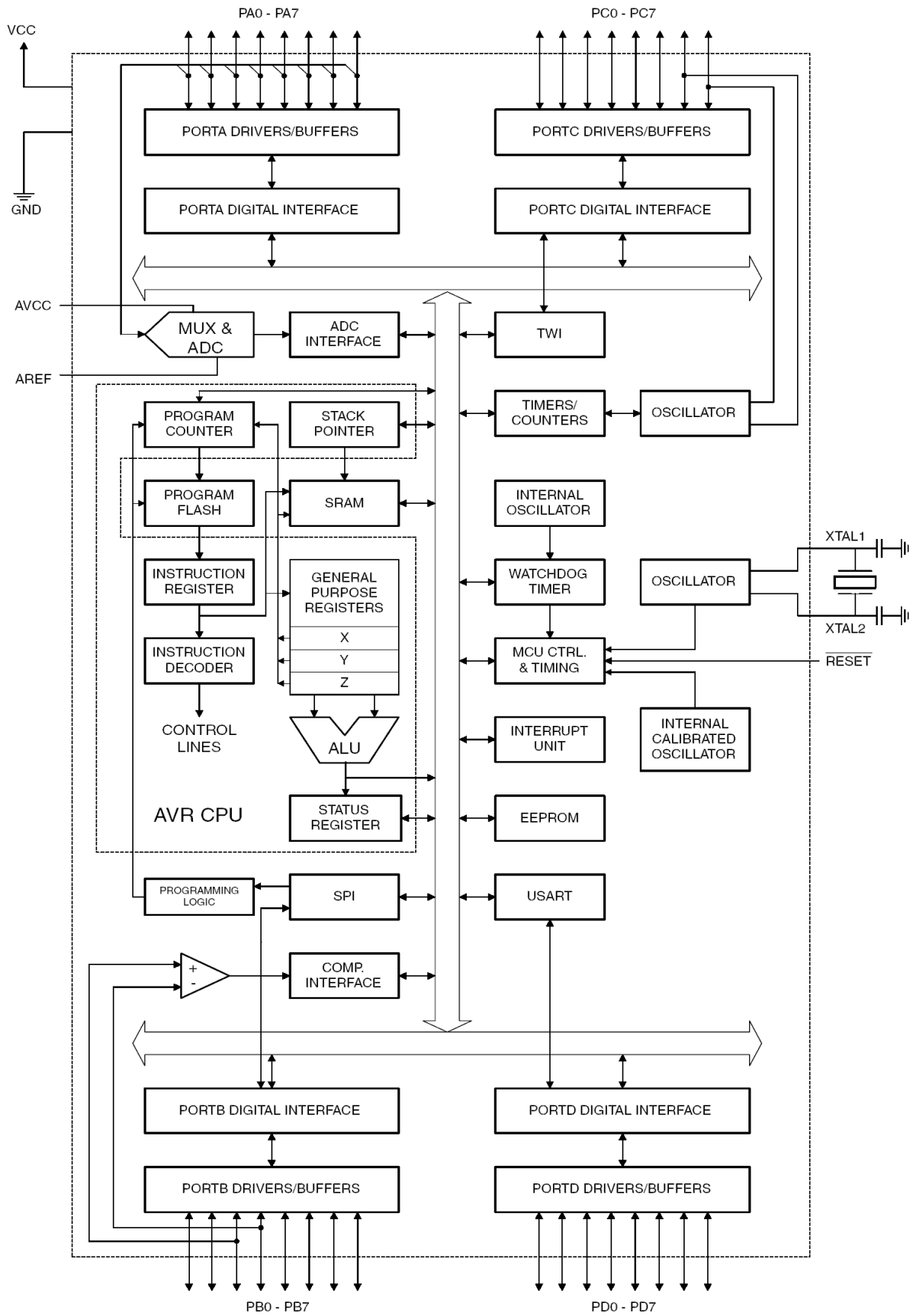

MEMORY MAP

Program Memory Map

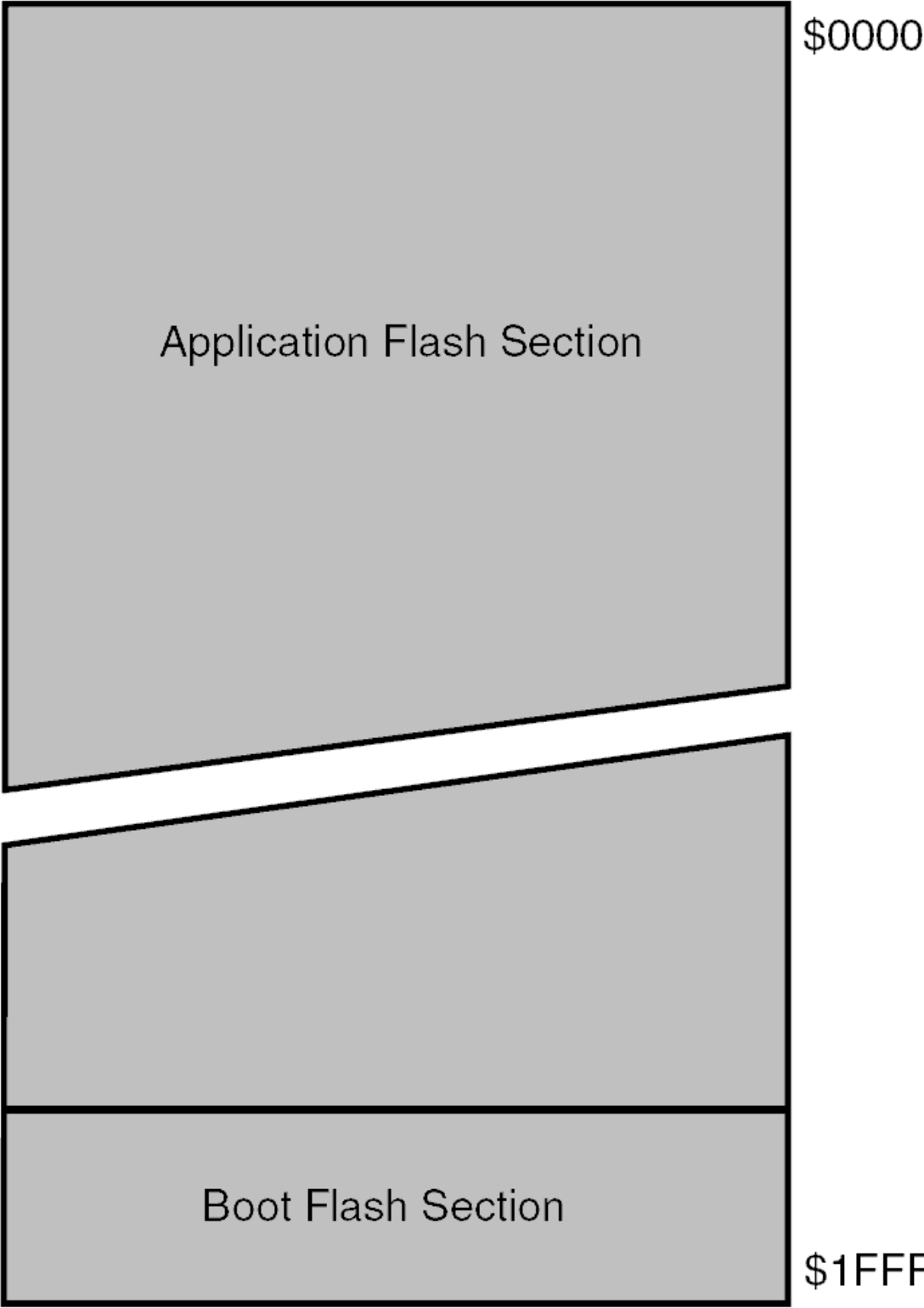

Data Memory Map

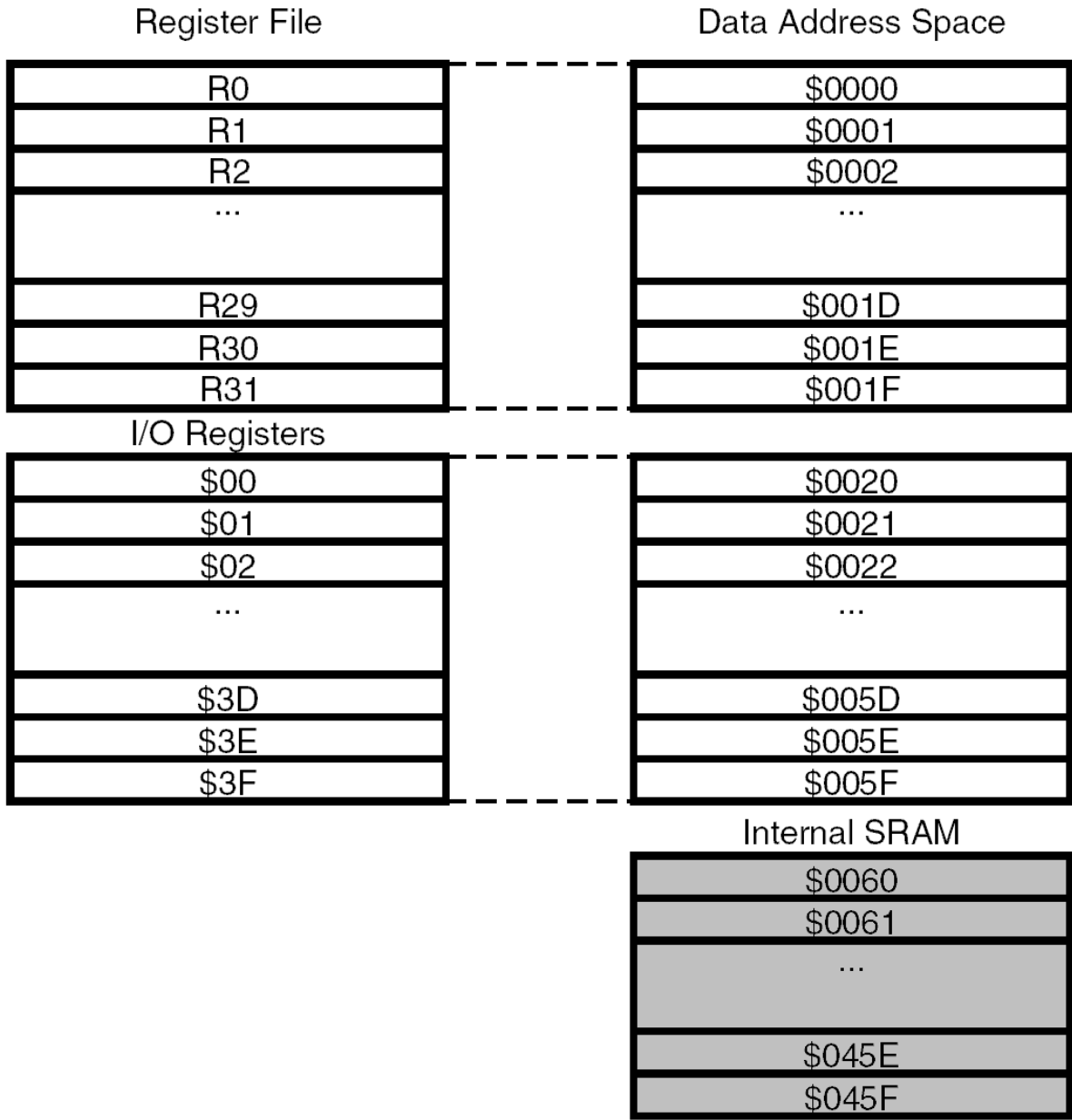

SCHEMATIC

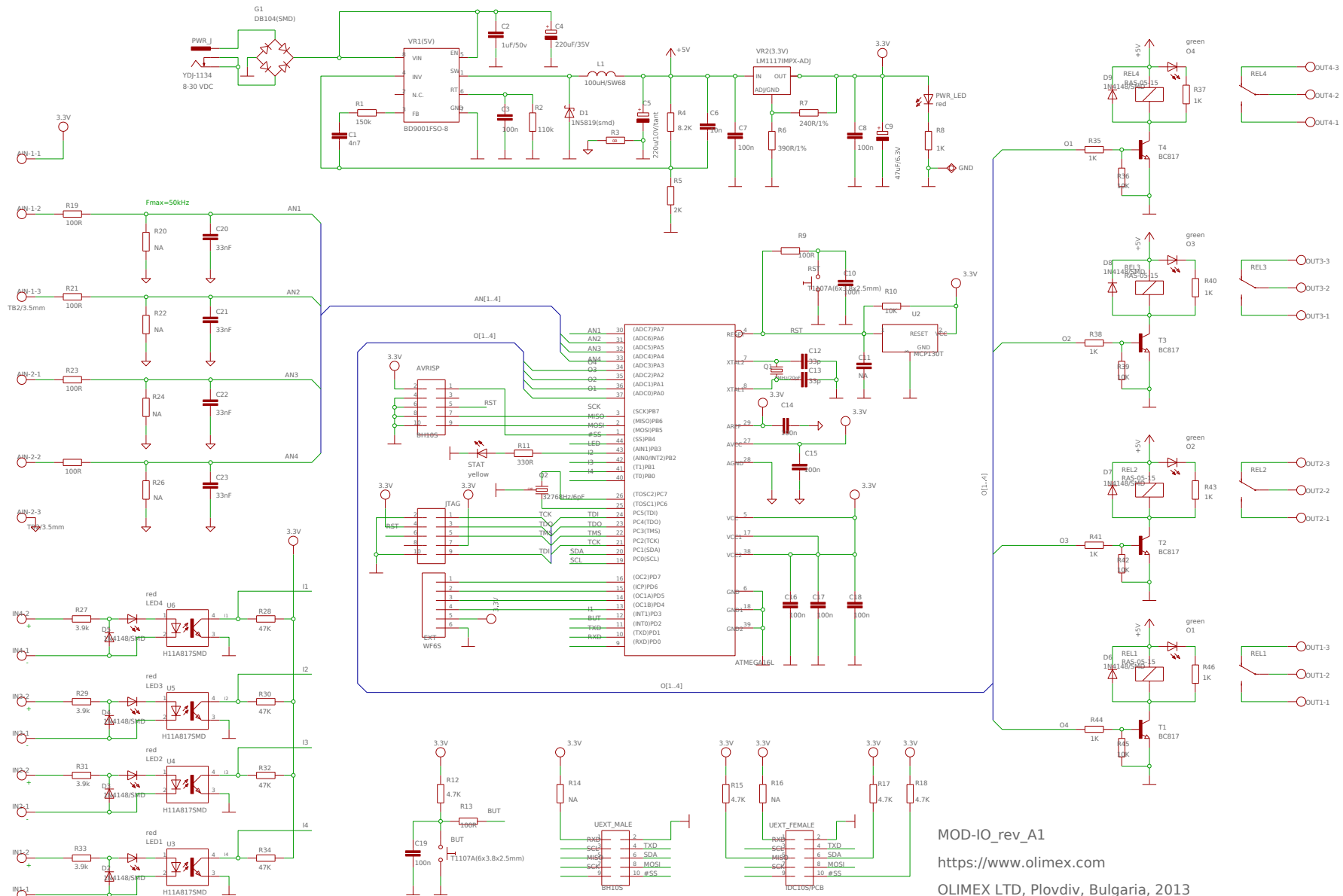

This schematic is released under the Creative Commons Attribution-Share Alike 3.0 United States License.

MOD-IO_rev A1

<https://www.olimex.com>

OLIMEX LTD, Plovdiv, Bulgaria, 2013

BOARD LAYOUT

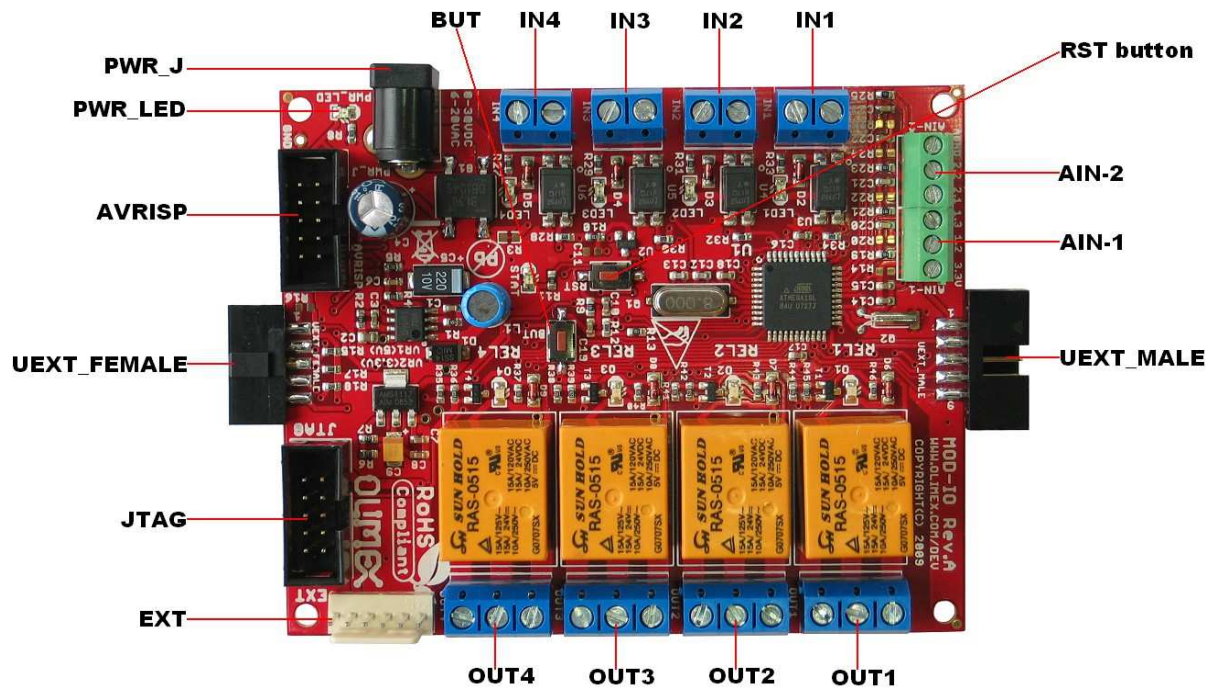

POWER SUPPLY CIRCUIT

MOD-IO is typically power supplied with 8-30V DC.

Power consumption when all relays are working is about 310 mA.

CLOCK CIRCUIT

Crystal Quartz 8 MHz connected to Atmega16l pin 7 (XTAL2) and pin 8 (XTAL1).

Crystal Quartz 32.768kHz connected to Atmega16L pin 25 ((TOSC1)PC6) and pin 26 ((TOSC2)PC7).

RESET CIRCUIT

MOD-IO reset circuit includes Reset scheme MCP130T (U2), AVRISP connector pin 5, JTAG connector pin 6, Atmega16L pin 4 (RESET), R9 (100Ohm), R10 (10k), C10 (100nF) and RST button.

CONNECTOR DESCRIPTIONS

AVRISP

| Pin # | Signal Name |
|-------|-------------|
| 1 | MOSI |
| 2 | 3.3V |
| 3 | NC |
| 4 | GND |
| 5 | RST |
| 6 | GND |
| 7 | SCK |
| 8 | GND |
| 9 | MISO |
| 10 | GND |

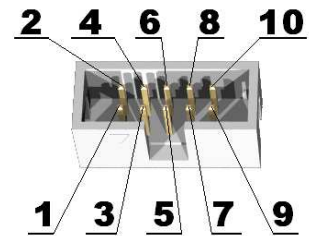

JTAG

| Pin # | Signal Name |
|-------|-------------|
| 1 | TCK |
| 2 | GND |
| 3 | TDO |
| 4 | 3.3V |
| 5 | TMS |
| 6 | RST |
| 7 | 3.3V |
| 8 | NC |
| 9 | TDI |
| 10 | GND |

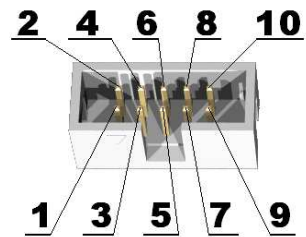

EXT

| Pin # | Signal Name |
|-------|-------------|
| 1 | PD7 |
| 2 | PD6 |
| 3 | PD5 |
| 4 | PD4 |
| 5 | 3.3V |
| 6 | GND |

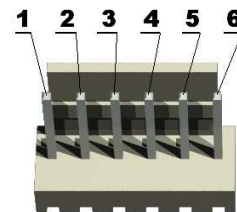

UEXT MALE

More info available here: <https://www.olimex.com/Products/Modules/UEXT/>

| Pin # | Signal Name |
|-------|-------------|
| 1 | NC |
| 2 | GND |
| 3 | RXD |
| 4 | TXD |
| 5 | SCL |
| 6 | SDA |
| 7 | MISO |
| 8 | MOSI |
| 9 | SCK |
| 10 | #SS |

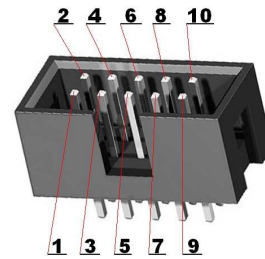

UEXT FEMALE

| Pin # | Signal Name |
|-------|-------------|
| 1 | NC |
| 2 | GND |
| 3 | RXD |
| 4 | TXD |
| 5 | SCL |
| 6 | SDA |
| 7 | MISO |
| 8 | MOSI |
| 9 | SCK |
| 10 | #SS |

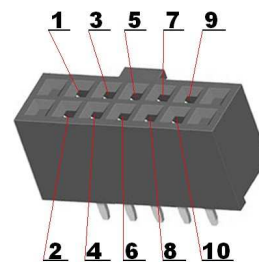

IN1, IN2 IN3, IN4

Please note that the opto-isolated inputs IN1, IN2, IN3, IN4 in earlier revisions were able to receive signals in the 3V to 6V range. R27, R29, R31, R33 were 330R and R28, R30, R32, R34 were R4.7k.

We have now adjusted the values of the resistors in that part of the schematic in latest revisions to allow higher voltage input in the 3.3V-24.0V range. R27, R29, R31, R33 are now R3.9k and R28, R30, R32, R34 are now R47k

| Pin # | Signal |
|-------|--------|
| 1 | - |
| 2 | + |



IN1 connected to (T0)PB0 – signal I4

IN2 connected to (T1)PB1 – signal I3

IN2 connected to (AIN0/INT2)PB2 – signal I2

IN4 connected to (INT1)PD3 – signal I1

OUT1, OUT2, OUT3, OUT4

OUT1 connected to (ADC3)PA3 – signal name O4

OUT2 connected to (ADC2)PA2 – signal name O3

OUT3 connected to (ADC1)PA1 – signal name O2

OUT4 connected to (ADC0)PA0 – signal name O1

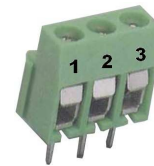

AIN-1

Please note that the analog inputs by default are as big as the input levels but you might change this. Just calculate the needed resistors R19/R20 and R21/R22.

| Pin # | Signal Name | Connected to |
|-------|-------------|--------------|
| 1 | 3.3V | VCC |
| 2 | AN1 | (ADC7)PA7 |
| 3 | AN2 | (ADC6)PA6 |

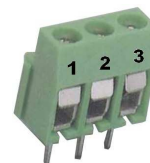

AIN-2

Please note that the analog inputs by default are as big as the input levels but you might change this. Just calculate (and mount/replace) the needed resistors R23/R24 and R25/R26.

| Pin # | Signal Name | Connected to |
|-------|-------------|--------------|
| 1 | AN3 | (ADC5)PA5 |
| 2 | AN4 | (ADC4)PA4 |
| 3 | AGND | Analog GND |

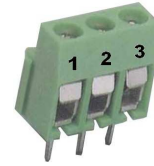

PWR_I

| Pin # | Signal Name |
|-------|-------------|
| 1 | Power Input |
| 2 | GND |

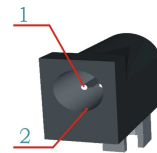

JUMPER DESCRIPTION

There are no jumpers on this board.

INPUT/OUTPUT

User button with name **BUT** – connected to Atmega16L pin 11 ((INT0)PD2).

Reset button with name **RST** – connected to Atmega16L pin 4 (RESET).

Status LED (yellow) with name **STAT** – connected via R11 (330 Ohm) to Atmega16L pin 43 ((AIN1)PB3).

Status LED (red) with name **LED1** – visualize input (IN1) state.

Status LED (red) with name **LED2** – visualize input (IN2) state.

Status LED (red) with name **LED3** – visualize input (IN3) state.

Status LED (red) with name **LED4** – visualize input (IN4) state.

Status LED (green) with name **O1** – visualize relay (REL1) state.

Status LED (green) with name **O2** – visualize relay (REL2) state.

Status LED (green) with name **O3** – visualize relay (REL3) state.

Status LED (green) with name **O4** – visualize relay (REL4) state.

Power-on LED (red) with name **PWR_LED** – shows that +3.3V voltage is applied to the board.

MECHANICAL DIMENSIONS

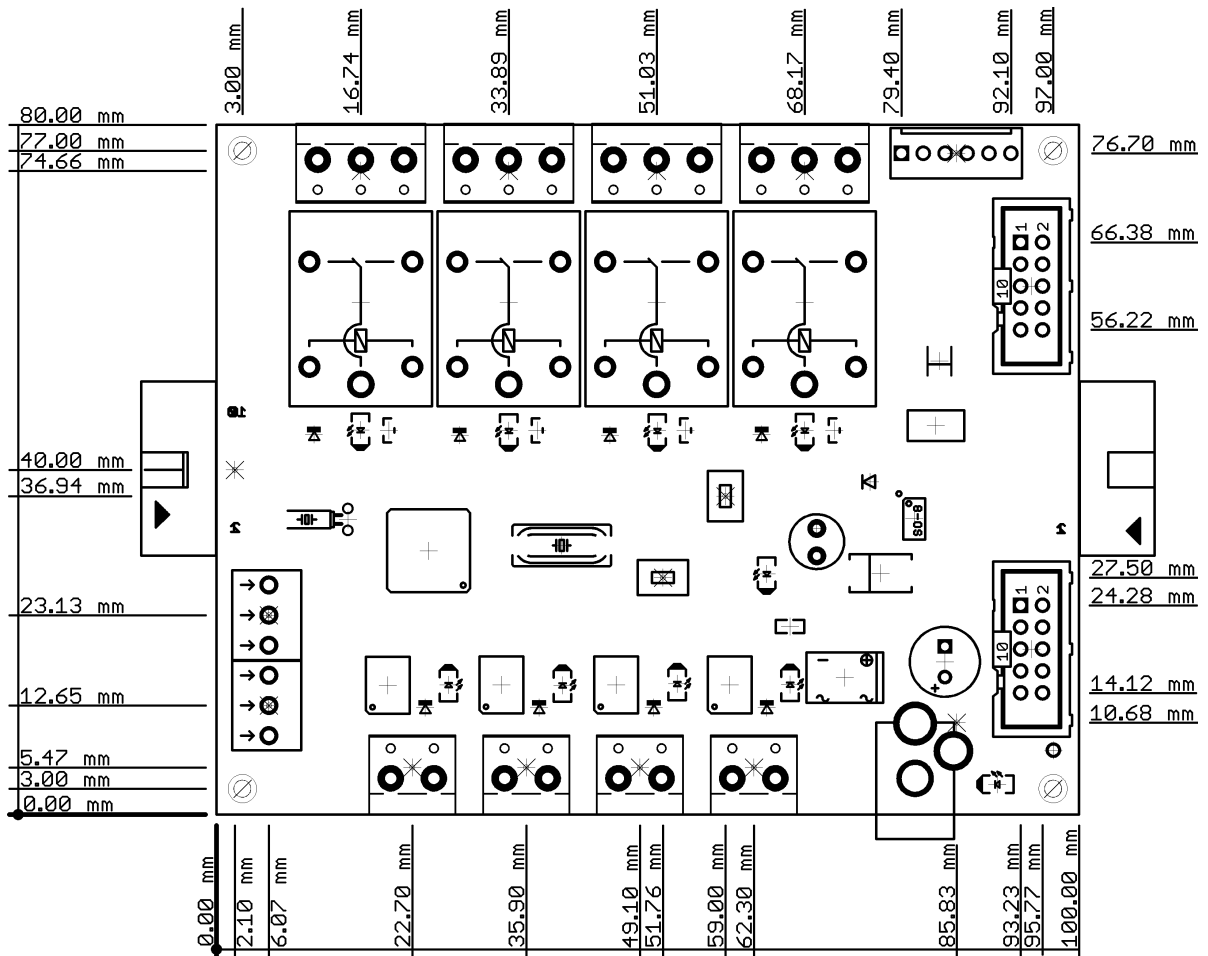

AVAILABLE DEMO SOFTWARE

There are two firmware available for MOD-IO: one is for RS232 control and the other is for I2C control. They might be found at the web page of MOD-IO.

Direct download links:

- [MOD-IO I2C \(newer\) firmware](#) C source and hex
- [MOD-IO RS232 \(older\) firmware](#) C source and hex

ORDER CODE

MOD-IO assembled and tested.

How to order?

You can order directly from our web shop or from any of our distributors. The list of distributors might be found here: <https://www.olimex.com/Distributors>.
Check our web <https://www.olimex.com> for more info.

Revision history:

| | |
|--------------------|--|
| Board's revision: | Rev. A - create November 2009 |
| Manual's revision: | Rev. B – edited September 2011 added more detailed INTRODUCTION and MECHANICAL DIMENSIONS |
| | Rev. C – edited March 2013 added new schematic, more information about AIN and IN inputs; IN input voltage adjusted; updated disclaimer and product support |

Disclaimer

© 2013 Olimex Ltd. Olimex®, logo and combinations thereof, are registered trademarks of Olimex Ltd. Other product names may be trademarks of others and the rights belong to their respective owners.

The information in this document is provided in connection with Olimex products. No license, express or implied or otherwise, to any intellectual property right is granted by this document or in connection with the sale of Olimex products.

The Hardware project is released under the Creative Commons Attribution-Share Alike 3.0 United States License. You may reproduce it for both your own personal use, and for commercial use. You will have to provide a link to the original creator of the project <https://www.olimex.com> on any documentation or website.

You may also modify the files, but you must then release them as well under the same terms. Credit can be attributed through a link to the creator website: <https://www.olimex.com>

The software is released under GPL.

It is possible that the pictures in this manual differ from the latest revision of the board.

The product described in this document is subject to continuous development and improvements. All particulars of the product and its use contained in this document are given by OLIMEX in good faith. However all warranties implied or expressed including but not limited to implied warranties of merchantability or fitness for purpose are excluded. This document is intended only to assist the reader in the use of the product. OLIMEX Ltd. shall not be liable for any loss or damage arising from the use of any information in this document or any error or omission in such information or any incorrect use of the product.

This evaluation board/kit is intended for use for engineering development, demonstration, or evaluation purposes only and is not considered by OLIMEX to be a finished end-product fit for general consumer use. Persons handling the product must have electronics training and observe good engineering practice standards. As such, the goods being provided are not intended to be complete in terms of required design-, marketing-, and/or manufacturing-related protective considerations, including product safety and environmental measures typically found in end products that incorporate such semiconductor components or circuit boards.

Olimex currently deals with a variety of customers for products, and therefore our arrangement with the user is not exclusive. Olimex assumes no liability for applications assistance, customer product design, software performance, or infringement of patents or services described herein.

THERE IS NO WARRANTY FOR THE DESIGN MATERIALS AND THE COMPONENTS USED TO CREATE MOD-IO. THEY ARE CONSIDERED SUITABLE ONLY FOR MOD-IO.

For product support, hardware information and error reports mail to: support@olimex.com. Note that we are primarily a hardware company and our software support is limited.

Please consider reading the paragraph below about the warranty of Olimex products.

Warranty and returns:

Our boards have lifetime warranty against manufacturing defects and components.

During development work it is not unlikely that you can burn your programmer or development board. This is normal, we also do development work and we have damaged A LOT of programmers and boards during our daily job so we know how it works. If our board/programmer has worked fine then stopped, please check if you didn't apply over voltage by mistake, or shorted something in your target board where the programmer was connected etc. Sometimes boards might get damaged by ESD shock voltage or if you spill coffee on them during your work when they are powered.

Please note that warranty do not cover problems caused by unproper use, shorts, over-voltages, ESD shock etc.

If the board has warranty label it should be not broken. Broken labels void the warranty, same applies for boards modified by the customer, for instance soldering additional components or removing components - such boards will be not be a subject of our warranty.

If you are positive that the problem is due to manufacturing defect or component you can return the board back to us for inspection.

When we receive the board we will check and if the problem is caused due to our fault and we will repair/replace the faulty hardware free of charge, otherwise we can quote price of the repair.

Note that all shippings back and forth have to be covered by the customer. Before you ship anything back you need to ask for RMA. When you ship back please attach to it your shipping address, phone, e-mail, RMA# and brief description of the problem. All boards should be sent back in antistatic package and well packed to prevent damages during the transport.