

MOD-ENC624J600 development board

Users Manual



All boards produced by Olimex are ROHS compliant

Rev. A, June 2011

Copyright(c) 2011, OLIMEX Ltd, All rights reserved

INTRODUCTION

MOD-ENC624J600 is development board with UEXT connector and 100 Mbit ENC624J600 ethernet controller from Microchip Technology Inc.

BOARD FEATURES

- MOD-ENC624J600 is the easiest way to add 100 Mbit ethernet connectivity to any of our boards with UEXT connector
- ENC624J600 Ethernet controller with UEXT connector for easy connection to our other development boards with UEXT connector
- LAN connector with build in transformer
- two status LEDs on LAN connector
- SPI/PARALLEL port interface to add Ethernet interface to your microcontroller project
- UEXT 10 pin interface on 0.1" row pins header
- PCB: FR-4, 1.5 mm (0,062"), soldermask, white silkscreen component print
- Dimensions: 46.99x36.83 mm (1.85 x 1.45")

ELECTROSTATIC WARNING

The MOD-ENC624J600 board is shipped in protective anti-static packaging. The board must not be subject to high electrostatic potentials. General practice for working with static sensitive devices should be applied when working with this board.

BOARD USE REQUIREMENTS

Hardware: Our development board PIC 32-WEB use ENC624J600

ETHERNET CONTROLLER FEATURES

MOD-ENC28J60 board use ENC624J600 stand-alone ethernet controller with these features:

- IEEE 802.3™ Compliant Fast Ethernet Controller
- Integrated MAC and 10/100Base-T PHY
- Hardware Security Acceleration Engines
- 24-Kbyte Transmit/Receive Packet Buffer SRAM
- Supports one 10/100Base-T Port with Automatic Polarity Detection and Correction
- Supports Auto-Negotiation
- Support for Pause Control Frames, including Automatic Transmit and Receive Flow Control
- Supports Half and Full-Duplex Operation
- Programmable Automatic Retransmit on Collision
- Programmable Padding and CRC Generation
- Programmable Automatic Rejection of Erroneous and Runt Packets
- Factory Preprogrammed Unique MAC Address
- MAC:
 - Support for Unicast, Multicast and Broadcast packets
 - Supports promiscuous reception
 - Programmable pattern matching
 - Programmable filtering on multiple packet formats, including Magic Packet™, Unicast, Multicast, Broadcast, specific packet match, destination address hash match or any packet
- PHY:
 - Wave shaping output filter
 - Internal Loopback mode
 - Energy Detect Power-Down mode
- Security Engines:
 - High-performance, modular exponentiation engine with up to 1024-bit operands
 - Supports RSA® and Diffie-Hellman key exchange algorithms
 - High-performance AES encrypt/decrypt engine with 128-bit, 192-bit or 256-bit key
 - Hardware AES ECB, CBC, CFB and OFB mode capability
 - Software AES CTR mode capability
 - Fast MD5 hash computations
 - Fast SHA-1 hash computations

- Buffer:
 - Configurable transmit/receive buffer size
 - Hardware-managed circular receive FIFO
 - 8-bit or 16-bit random and sequential access
 - High-performance internal DMA for fast memory copying
 - High-performance hardware IP checksum calculations
 - Accessible in low-power modes
 - Space can be reserved for general purpose application usage in addition to transmit and receive packets
- Operational:
 - Outputs for two LED indicators with support for single and dual LED configurations
 - Transmit and receive interrupts
 - 25MHz clock
 - 5V tolerant inputs
 - Clock out pin with programmable frequencies from 50 kHz to 33.3 MHz
 - Operating voltage range of 3.0V to 3.6V
 - Temperature range: -40°C to +85°C industrial

BLOCK DIAGRAM

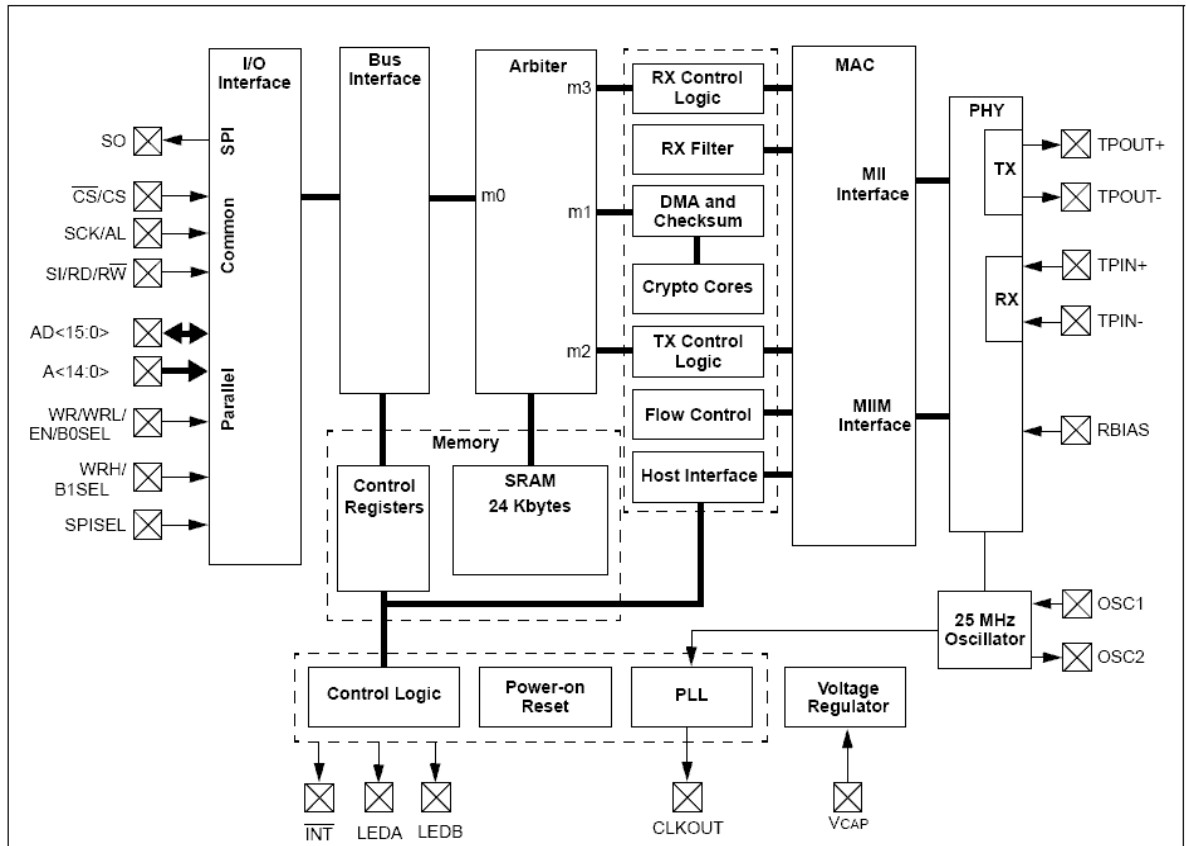

MEMORY MAP

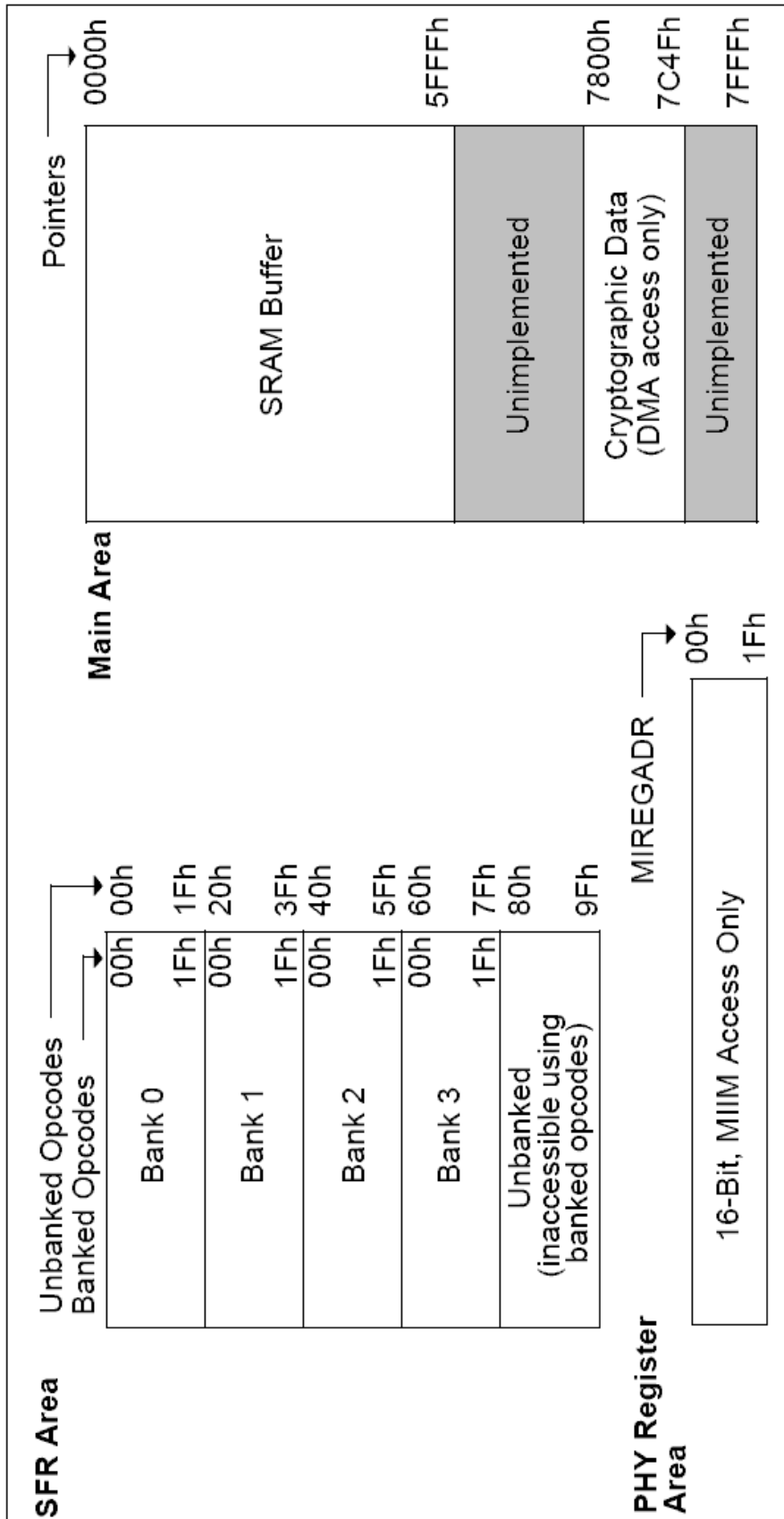

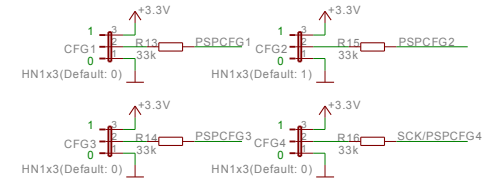
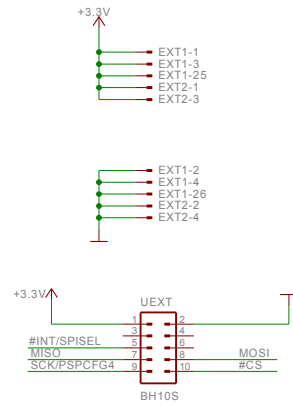
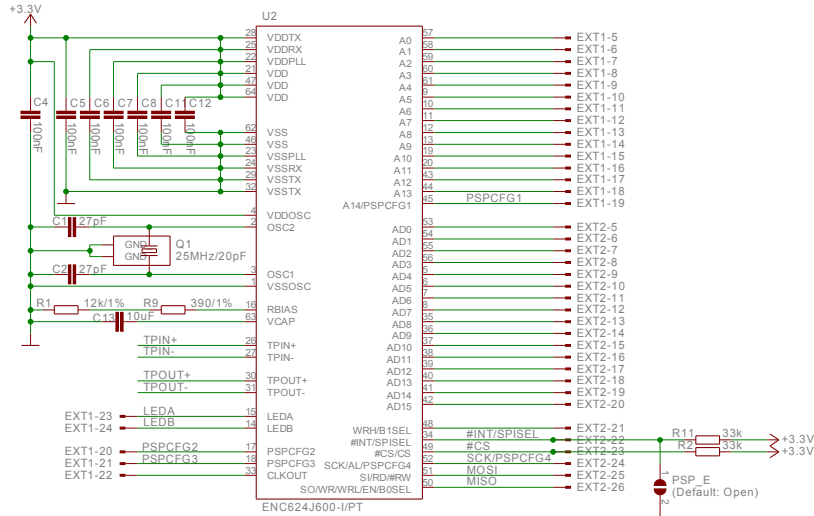

MOD-ENC624J600

Rev. Initial
 COPYRIGHT(C) 2009, OLIMEX LTD
<http://www.olimex.com/dev>

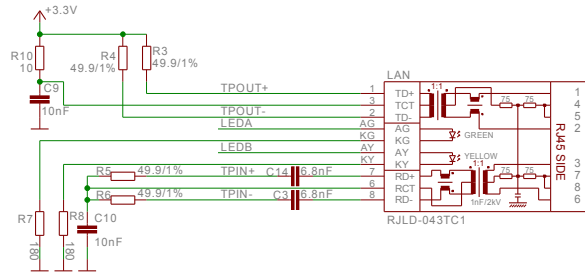

BOARD LAYOUT

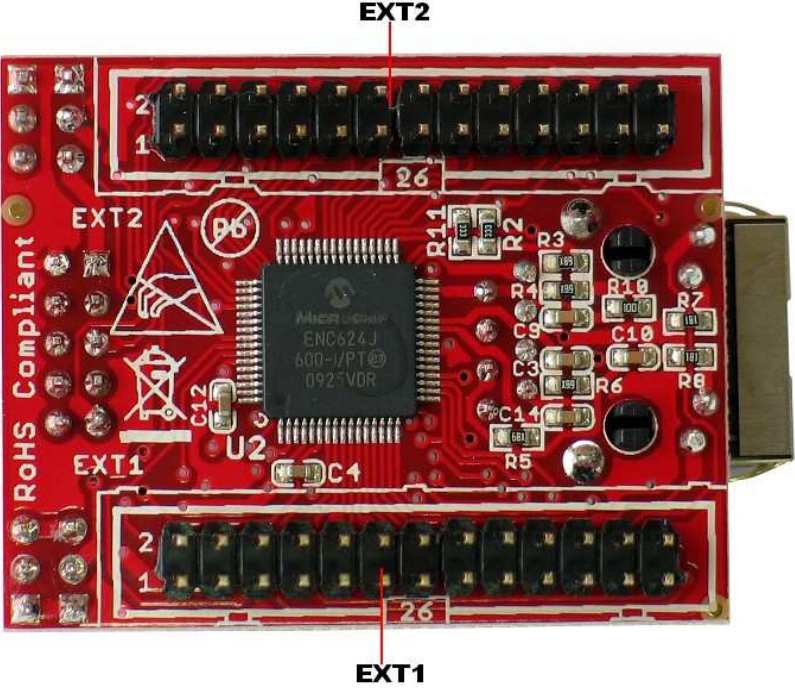
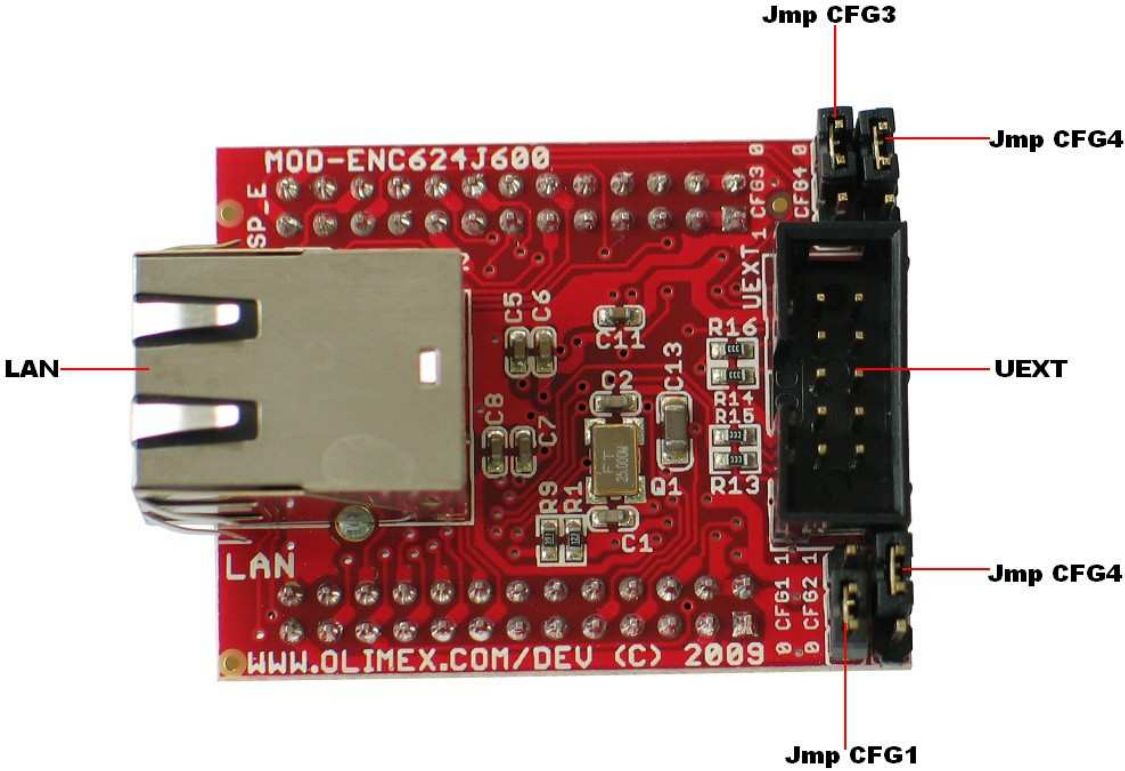

POWER SUPPLY CIRCUIT

MOD-ENC624J600 is typically power supplied by UEXT pin 1 and pin 2, EXT1 - pins 1, 3, 25 and pins 2, 4, 26, EXT2 - pins 1, 3 and 2, 4.

CLOCK CIRCUIT

Quartz crystal 25 MHz is connected to ENC624J600 pin 2 (OSC2) and pin3 (OSC1).

JUMPER DESCRIPTION

PSP_E



When is closed this jumper enables PSP mode.

Default state is open.

CFG1, CFG2, CFG3, CFG4

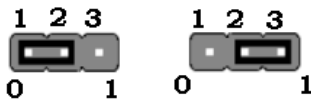

MOD-ENC624J600 works in several modes. Jumpers position define the working mode :

PSP Mode 9:

CFG1 - in position "0"

CFG2 - in position "1"

CFG3 - in position "1"

CFG4 - in position "0"

PSP Mode 3:

CFG1 - in position "0"

CFG2 - in position "1"

CFG3 - in position "0"

CFG4 - in position "0"

SPI Mode - connected to SPI2:

CFG1 - doesn't matter

CFG2 - doesn't matter

CFG3 - doesn't matter

CFG4 - doesn't matter

PSP_E - open

CONNECTOR DESCRIPTION

UEXT

Pin #	Signal Name
1	+3.3V
2	GND
3	NC
4	NC
5	#INT/SPISEL
6	NC
7	MISO
8	MOSI
9	SCK/PSPCFG4
10	#CS

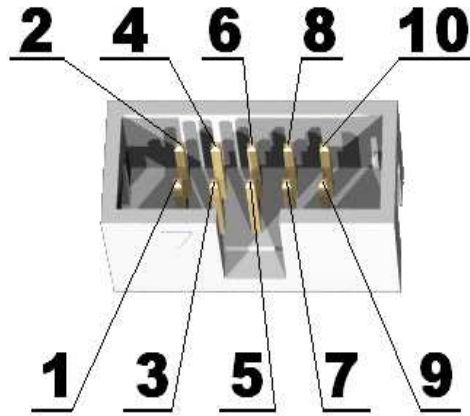

LAN

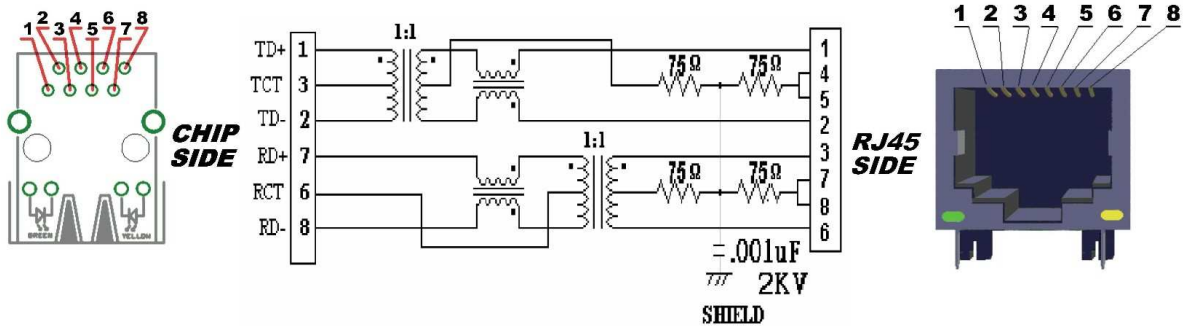

Pin #	Signal Name Chip Side	Pin #	Signal Name Chip Side
1	TX+	5	Not Connected (NC)
2	TX-	6	VDD
3	VDD	7	RX+
4	Not Connected (NC)	8	RX-

LED	Color	Usage
Right	Green	Link status
Left	Yellow	Activity status

EXT1

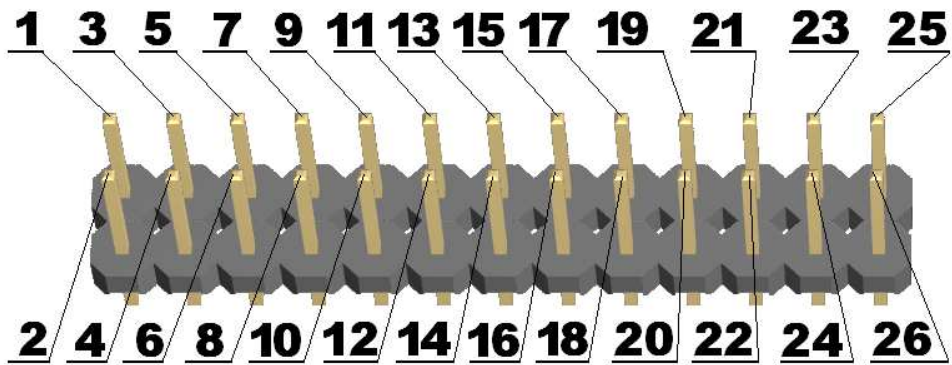

Pin #	Signal Name	Pin #	Signal Name
1	3.3V	2	GND
3	3.3V	4	GND
5	A0	6	A1
7	A2	8	A3
9	A4	10	A5
11	A6	12	A7
13	A8	14	A9
15	A10	16	A11
17	A12	18	A13
19	PSPCFG1	20	PSPCFG2
21	PSPCFG3	22	CLKOUT
23	LEDA	24	LEDB
25	3.3V	26	GND

EXT2

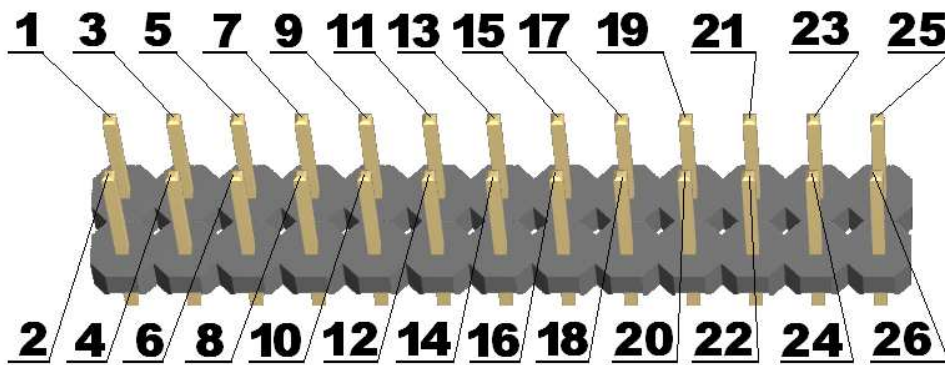

Pin #	Signal Name	Pin #	Signal Name
1	3.3V	2	GND
3	3.3V	4	GND
5	AD0	6	AD1
7	AD2	8	AD3
9	AD4	10	AD5
11	AD6	12	AD7
13	AD8	14	AD9
15	AD10	16	AD11
17	AD12	18	AD13
19	AD14	20	AD15
21	WRH/B1SEL	22	#INT/SPISEL
23	#CS	24	SCK/PSPCFG4
25	MOSI	26	MISO

MECHANICAL DIMENSIONS

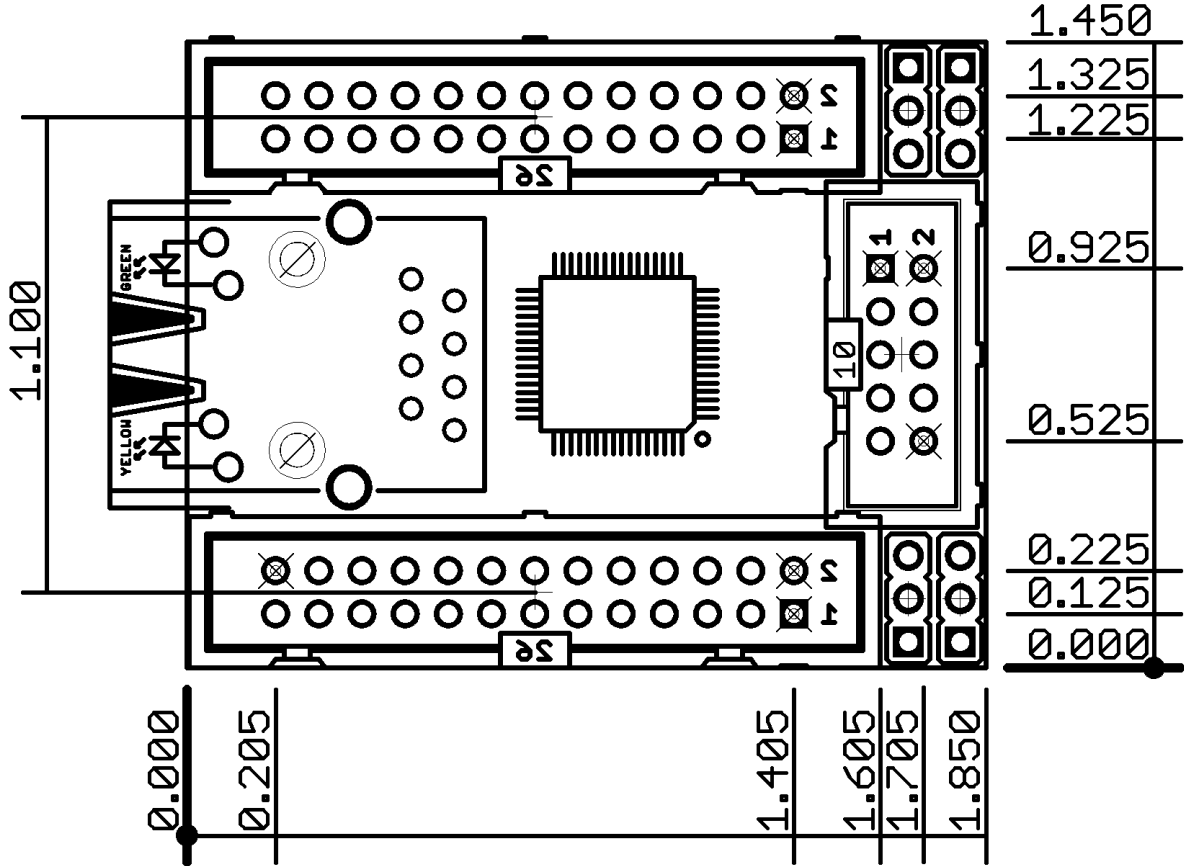

All measures are in inches.

AVAILABLE DEMO SOFTWARE

- Microchip's TCP-IP stack full featured TCP-IP stack, very easy to configure and use with PIC microcontrollers.
- Demo code with PIC32-WEB board

ORDER CODE

MOD-ENC624J600 Completely assembled and tested, includes ENC624J600 Ethernet controller

How to order?

You can order to us directly or by any of our distributors.

Check our web www.olimex.com/dev for more info.

Revision history:

Rev. Initial	- create November 2009
Rev. A	- edited June 2011 - added more detailed mechanical dimensions

Disclaimer:

© 2011 Olimex Ltd. All rights reserved. Olimex®, logo and combinations thereof, are registered trademarks of Olimex Ltd. Other terms and product names may be trademarks of others.

The information in this document is provided in connection with Olimex products. No license, express or implied or otherwise, to any intellectual property right is granted by this document or in connection with the sale of Olimex products.

Neither the whole nor any part of the information contained in or the product described in this document may be adapted or reproduced in any material from except with the prior written permission of the copyright holder.

The product described in this document is subject to continuous development and improvements. All particulars of the product and its use contained in this document are given by OLIMEX in good faith. However all warranties implied or expressed including but not limited to implied warranties of merchantability or fitness for purpose are excluded.

This document is intended only to assist the reader in the use of the product. OLIMEX Ltd. shall not be liable for any loss or damage arising from the use of any information in this document or any error or omission in such information or any incorrect use of the product.