

3 TURNS CERMET TRIMMERS

TM-7

RoHS compliant

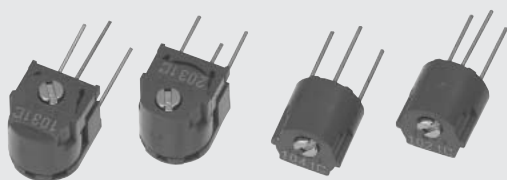

FEATURES

- RoHS compliant
- Fine setting is possible
- Extremely small backlash (In house comparison)

INTERNAL STRUCTURE

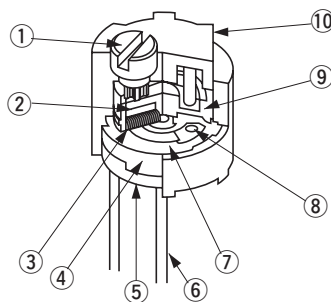

Part name	Material	Flammability
① Shaft	Zinc alloy, Nickel-plated	—
② Rubber cushion	Silicone rubber	
③ Wiper	Multi metal alloy	
④ Base element	Ceramic	
⑤ Adhesive	Epoxy	UL-94V-0
⑥ Terminal pin	Copper, Tin-plated	—
⑦ Resistive element	RuO ₂ cermet	
⑧ Electrode	Ag-Pd cermet	
⑨ Rotor gear	Polyamide	UL-94HB
⑩ Housing	PBT(Polybutyleneterephthalate)	UL-94V-0



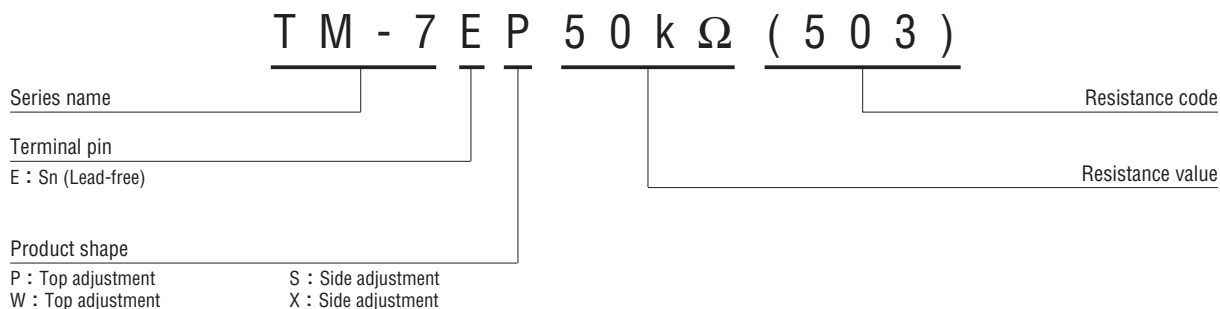



PART NUMBER DESIGNATION



※Please refer to the LIST OF PART NUMBERS when placing orders.

TM-7 CERMET TRIMMERS

LIST OF PART NUMBERS

Adjustment position	Shape of terminal (Top view)	Form of packaging	Pieces in package
		Plastic bag	
Top adjustment 		TM-7EP	50 pcs./pack
		TM-7EW	
Side adjustment (↑ Adjustment direction) 		TM-7ES	
		TM-7EX	

<Nominal resistance values>

50 Ω	100 Ω	200 Ω	500 Ω	1 kΩ	2 kΩ	5 kΩ	10 kΩ
20 kΩ	50 kΩ	100 kΩ	200 kΩ	500 kΩ	1 MΩ	2 MΩ	

Fig. 1

※ The above part numbers are all available as the standard item respectively with the combination of <Nominal resistance values> (Fig. 1).
 ※ Verify the above part numbers when placing orders.

ELECTRICAL CHARACTERISTICS

Nominal resistance range	50 Ω ~ 2 MΩ
Resistance tolerance	± 10 %
Power ratings	0.5 W (70 °C) 0 W (120 °C)
Resistance law	Linear law
Maximum input voltage	DC300 V or power rating, whichever is smaller
Maximum wiper current	100 mA or power rating, whichever is smaller
Effective electrical turn	2.5 turns
End resistance	1 % or 2 Ω, whichever is greater
C.R.V.	1 % or 3 Ω, whichever is greater
Operating temp. range	-55 ~ 120 °C
Temp. coefficient	± 100 10 ⁻⁶ /°C maximum
Insulation resistance	1000 MΩ minimum (DC500 V)
Dielectric strength	AC900 V, 60 s
Net weight	Approx. 0.50 g (TM-7EP, EW) Approx. 0.69 g (TM-7ES, EX)

MECHANICAL CHARACTERISTICS

Mechanical turn	3 turns
Operating torque	20 mN·m {204 gf·cm} maximum
Mechanical stop	Clutch action
Rotational life	200 cycles ΔR/R ≤ ± (2 Ω + 3 %)
Terminal strength	10 N {1.02 kgf} minimum (Tensile strength)
Thrust to shaft	10 N {1.02 kgf} minimum
Solderability	245 ± 3 °C, 2 ~ 3 s

{ } : Reference only

ENVIRONMENTAL CHARACTERISTICS

Test item	Test conditions	Specifications
Thermal shock	-65 ~ 125 °C (0.5 h), 5 cycles	[ΔR/R ≤ 1 %] [S.S. ≤ 1 %]
Humidity	-10 ~ 65 °C (80 ~ 98 %), 10 cycles, 240 h	[ΔR/R ≤ 2 %]
Shock	981 m/s ² , 6 ms 6 directions for 3 times each	[ΔR/R ≤ 1 %] [S.S. ≤ 1 %]
Vibration	Amplitude 1.52 mm or Acceleration 196 m/s ² , 10 ~ 2000 Hz, 3 directions, 12 times each	
Load life	70 °C, 0.5 W, 1000 h	[ΔR/R ≤ 3 %] [S.S. ≤ 1 %]
Low temp. operation	-55 °C, 2 h	[ΔR/R ≤ 2 %] [S.S. ≤ 2 %]
High temp. exposure	120 °C, 250 h	[ΔR/R ≤ 3 %] [S.S. ≤ 2 %]
Immersion seal	85 °C, 60 s	No leaks (No continuous bubbles)
Soldering heat	Flow soldering 260 ± 3 °C, 5 ~ 6 s, two times maximum Manual soldering 380 ± 10 °C, 3 ~ 4 s	[ΔR/R ≤ 1 %]

ΔR/R : Change in total resistance
 S.S. : Setting stability

TM-7 CERMET TRIMMERS

MAXIMUM INPUT RATINGS

Nominal resistance values (Ω)	Resistance code	Maximum input voltage (V)	Maximum wiper current (mA)
50	500	5.00	100
100	101	7.07	70.7
200	201	10.0	50.0
500	501	15.8	31.6
1 k	102	22.4	22.4
2 k	202	31.6	15.8
5 k	502	50.0	10.0
10 k	103	70.7	7.07
20 k	203	100	5.00
50 k	503	158	3.16
100 k	104	224	2.24
200 k	204	300	1.50
500 k	504	300	0.60
1 M	105	300	0.30
2 M	205	300	0.15

OUTLINE DIMENSIONS

TM-7EP Top adjustment

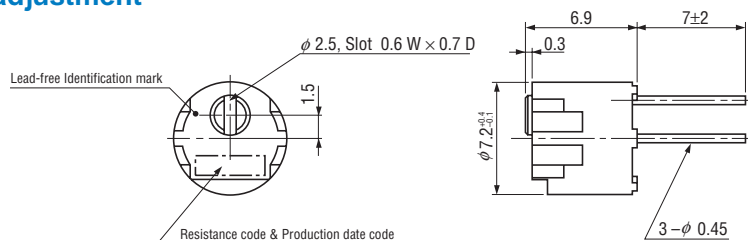

Unless otherwise specified, tolerance: ± 0.3 (Unit: mm)

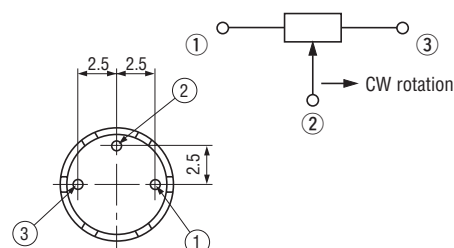

TM-7EW Top adjustment

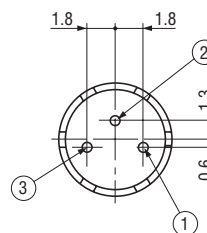
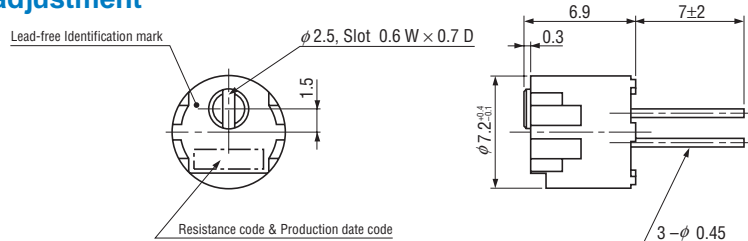

★ Pin pitch in W type is different from P type.

TM-7ES Side adjustment

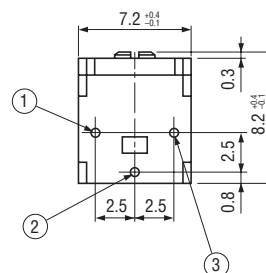
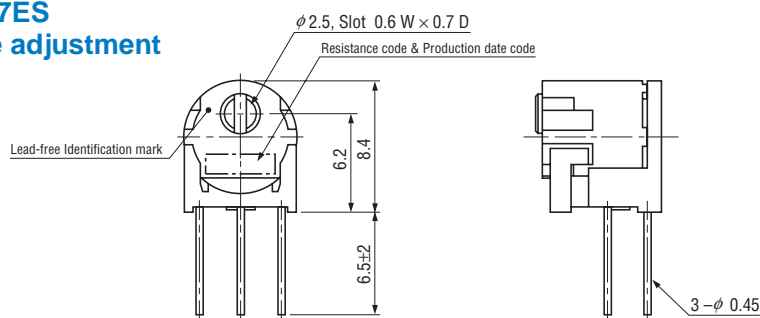

TM-7 CERMET TRIMMERS

OUTLINE DIMENSIONS

● TM-7EX Side adjustment

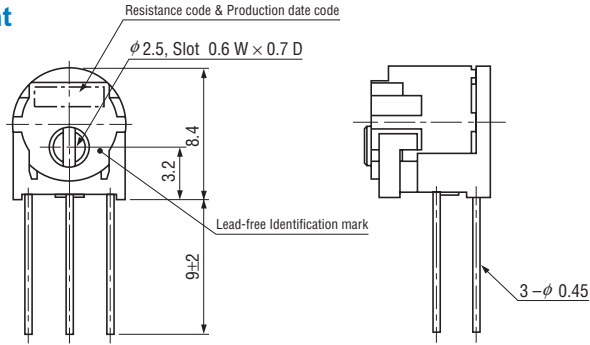

Unless otherwise specified, tolerance: ± 0.3 (Unit: mm)

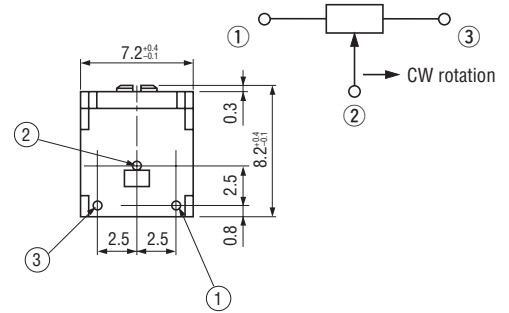

★ Pin position & shaft position of X type are different from S type.

PACKAGING SPECIFICATIONS

<Bulk pack specifications>

- Unit of bulk in a plastic bag is 50 pcs. per pack.
- Boxing of bulk in a plastic bag is performed with 200 pcs. per box.