

SMT Air Coil Inductor

AIAC-2712C

RoHS
Compliant

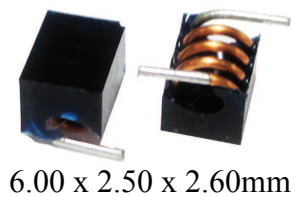

6.00 x 2.50 x 2.60mm

FEATURES:

- High current design
- Wide Range Frequency Response
- Excellent Q & SRF
- Standard flat cap top suitable for automatic placement.

APPLICATIONS:

- Widely used in Cordless Phones, High Frequency Communication Equipments, Intercom, CATV,RFID
- Suitable for metal sensors and proximity sensors
- Noise suppression for RF power supply/bias
- I/O filtering, frequency selection for audio devices such as Loudspeakers,Hifi
- Impedance Matching for transceivers
- Improves switch isolation for RF circuit

STANDARD SPECIFICATIONS:

| PARAMETERS | |
|------------------------|------------------|
| ABRACON P/N: | AIAC-2712C |
| Operating temperature: | -40 °C ~ +125 °C |
| Storage temperature: | -25°C to + 60°C |

| Part Number | Inductance | Tolerance | DCR (Max) | Q(Min) | SRF(Min) | Rated Current (Max) | Inductance Code |
|-----------------|------------|-----------|-----------|--------|----------|---------------------|-----------------|
| Units | nH | % | mΩ | | GHz | A | |
| Symbol | L | J | DCR | | | IDC | |
| AIAC-2712C-17N5 | 17.50 | J | 4.5 | 100.0 | 2.2 | 3.5 | 17N5J |
| AIAC-2712C-22N0 | 22.00 | J | 5.0 | 100.0 | 2.0 | 3.0 | 22N0J |
| AIAC-2712C-28N0 | 28.00 | J | 5.6 | 100.0 | 1.8 | 2.8 | 28N0J |
| AIAC-2712C-35N5 | 35.50 | J | 6.2 | 100.0 | 1.2 | 2.7 | 35N5J |
| AIAC-2712C-43N5 | 43.50 | J | 6.7 | 100.0 | 1.0 | 2.5 | 43N5J |

Test Conditions and equipments

Test frequency: 150MHz

Equipment: HP4191A

PART IDENTIFICATION:

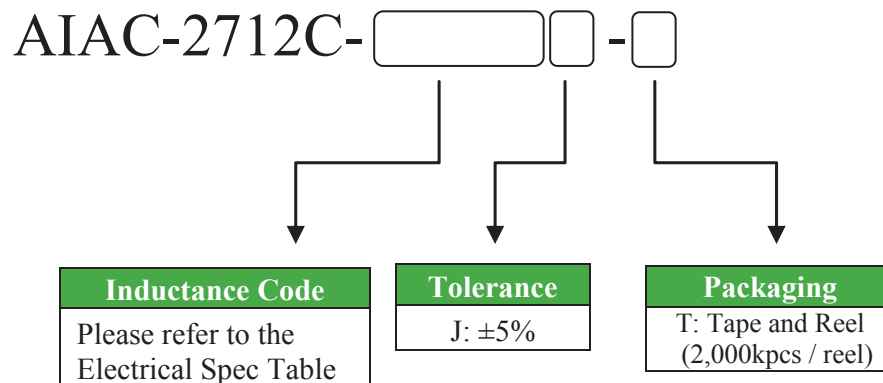

SMT Air Coil Inductor

AIAC-2712C

RoHS
Compliant

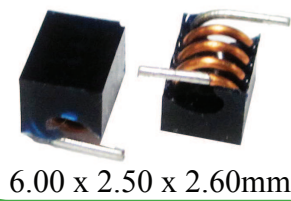

6.00 x 2.50 x 2.60mm

OUTLINE DRAWING:

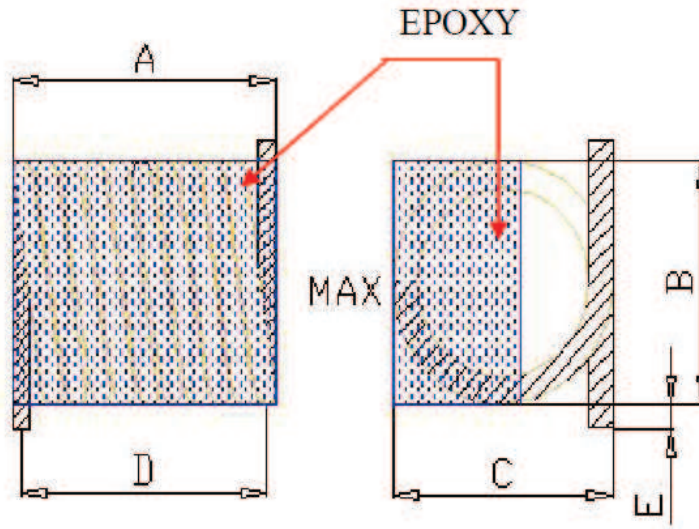

| A | B | C | D | E |
|----------|----------|----------|----------|----------|
| 6.00±0.3 | 2.50±0.2 | 2.60±0.2 | 5.80±0.3 | 0.70±0.2 |

Schematic

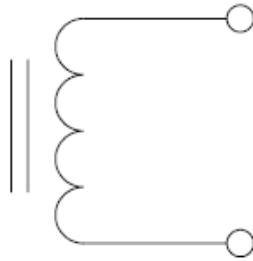

Recommended Land Pattern

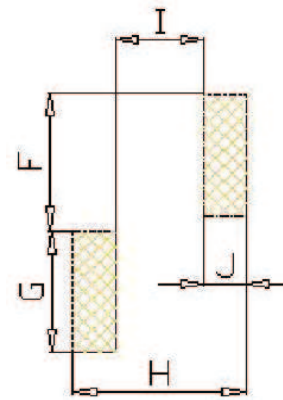

| F | G | H | I | J |
|-----|-----|-----|-----|-----|
| 2.8 | 3.3 | 7.4 | 4.9 | 1.3 |

Dimension: mm

SMT Air Coil Inductor

AIAC-2712C

RoHS
Compliant

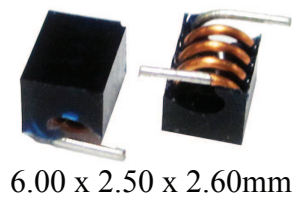

6.00 x 2.50 x 2.60mm

REFLOW PROFILE:

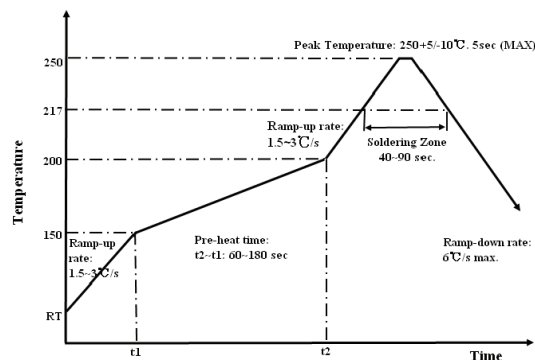

TAPE & REEL:

Packing
T: 2,000pcs / reel

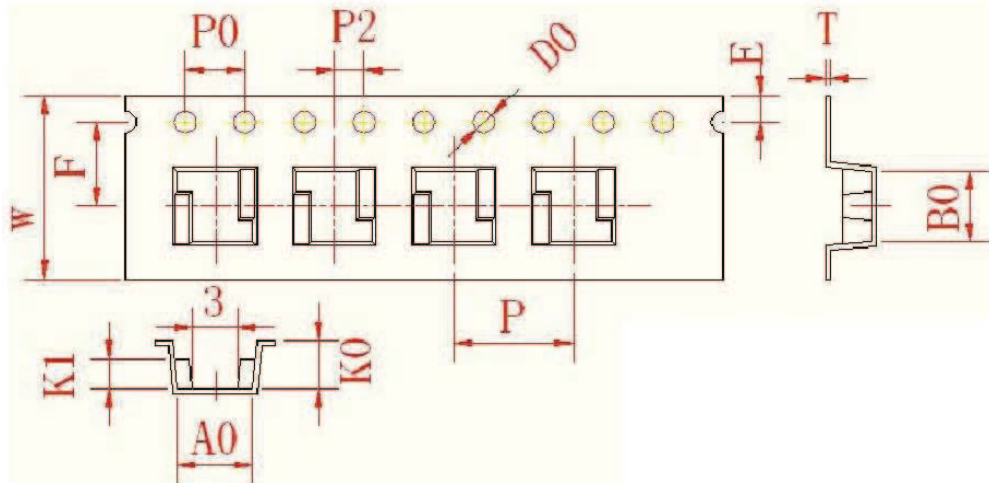

| W | A0 | B0 | K0 | K1 | P | F | E | D0 | P0 | P2 | T |
|----------|---------|---------|---------|---------|---------|---------|----------|------------|---------|---------|-----------|
| 16.0±0.3 | 4.7±0.1 | 6.8±0.1 | 3.2±0.1 | 2.0±0.1 | 8.0±0.1 | 7.5±0.1 | 1.75±0.1 | 1.5+0.1/-0 | 4.0±0.1 | 2.0±0.1 | 0.35±0.05 |

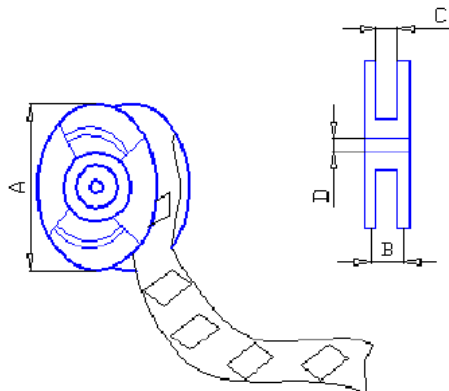

| | |
|---|-----|
| A | 330 |
| B | 22 |
| C | 16 |
| D | 13 |

Dimension: mm

ATTENTION: Abracon Corporation's products are COTS – Commercial-Off-The-Shelf products; suitable for Commercial, Industrial and, where designated, Automotive Applications. Abracon's products are not specifically designed for Military, Aviation, Aerospace, Life-dependant Medical applications or any application requiring high reliability where component failure could result in loss of life and/or property. For applications requiring high reliability and/or presenting an extreme operating environment, written consent and authorization from Abracon Corporation is required. Please contact Abracon Corporation for more information.

ABRACON IS
ISO 9001:2008
CERTIFIED



Visit www.abracon.com for Terms & Conditions of Sale
30332 Esperanza, Rancho Santa Margarita, California 92688
tel 949-546-8000 | fax 949-546-8001 | www.abracon.com

Revised: 11.20.12