

Molding Type Power Inductor

ASPI-0520LR



RoHS
Compliant



5.6 x 5.2 x 2.0 mm

FEATURES:

- High saturation current.
- Low loss due to low DC resistance.
- Frequency application up to 3MHz.
- Low profile with max thickness 2.0mm.
- 100% lead free and metted RoHS standard.
- Suitable for reflow soldering.
- High reliable SMD package

APPLICATIONS:

- DC/DC converters in Notebook, Netbook, desktop and server
- Low profile, high current power supplies.

STANDARD SPECIFICATIONS

Abrakon P/N:	ASPI-0520LR Series
Operating Temperature & Humidity:	-55°C to +125°C (Including self generated heat)
Storage Temperature & Humidity:	+25°C to +35°C, 45% to 85% RH

Part Number	Inductance	Tolerance	DCR Typ	DCR Max	Saturation Current	Temperature Rise Current
Units	μH	%	mΩ	mΩ	A	A
Symbol	L	M			Isat*	Irms*
ASPI-0520LR-1R0	1.0	M	16.8	18.5	8.0	7.5
ASPI-0520LR-2R2	2.2	M	33.0	36.0	5.0	5.5
ASPI-0520LR-3R3	3.3	M	45.0	50.0	4.2	4.5
ASPI-0520LR-4R7	4.7	M	52.0	58.0	3.7	3.7
ASPI-0520LR-5R6	5.6	M	65.0	75.0	3.3	3.5

Test Conditions

Inductance is measured in HP-4285A Precision LCR Meter.

RDC is measured in HP-4338B milli ohm meter.(or equivalent).

Isat: Based on inductance change ($\Delta L/L_0 : \leq -20\%$)

Irms: Based on temperature rise ($\Delta T : 40^\circ\text{C TYP.}$)

ELECTRICAL CHARACTERISTIC CURVES

ASPI-0520LR-1R0

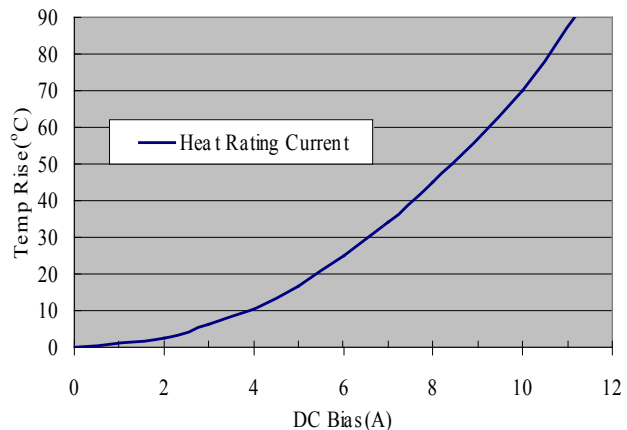
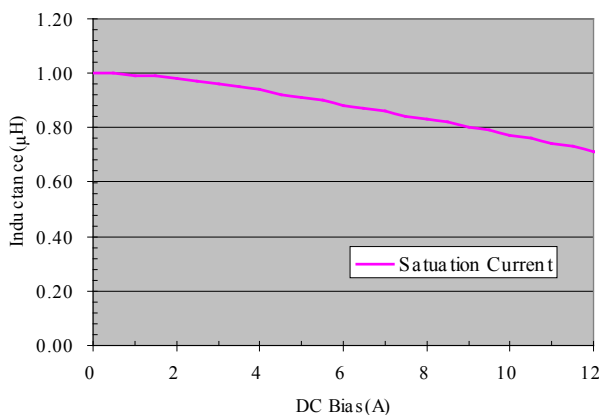

Molding Type Power Inductor

ASPI-0520LR



5.6 x 5.2 x 2.0 mm

ELECTRICAL CHARACTERISTIC CURVES

ASPI-0520LR-2R2

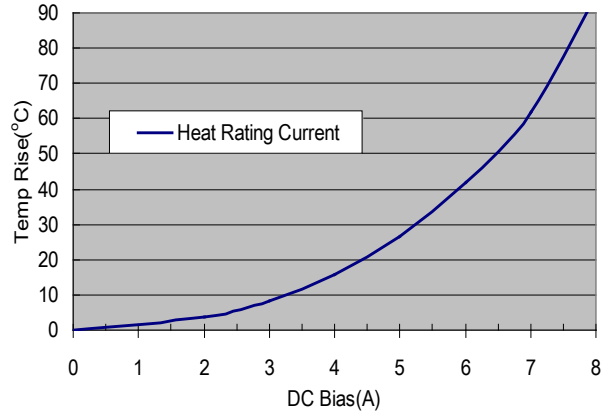
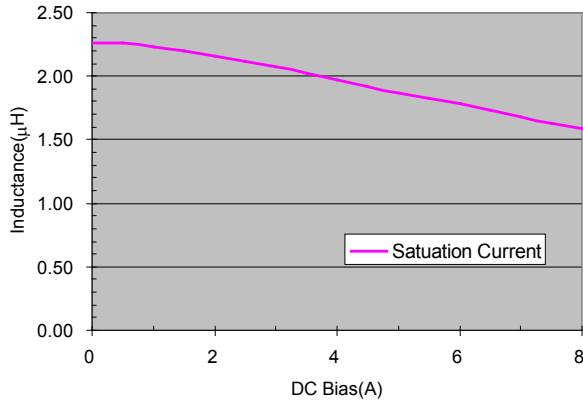

ASPI-0520LR-3R3

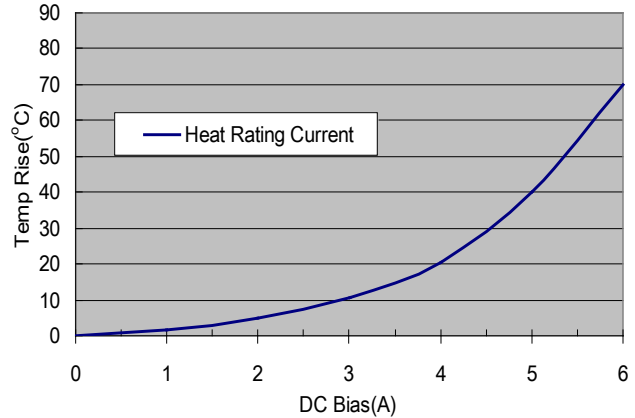
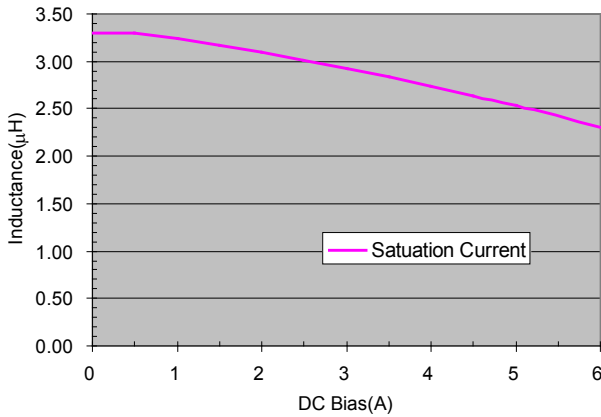

ASPI-0520LR-4R7

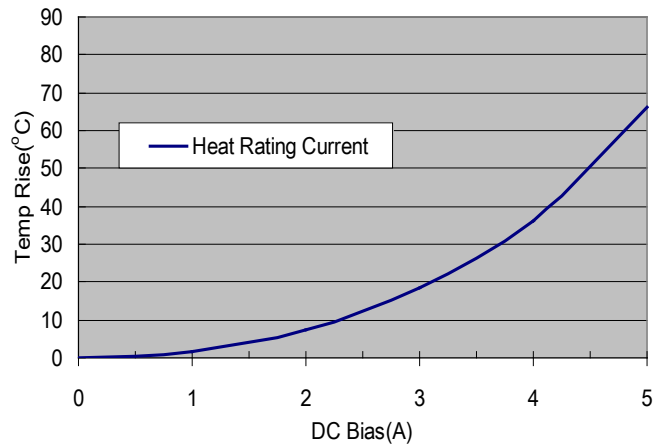
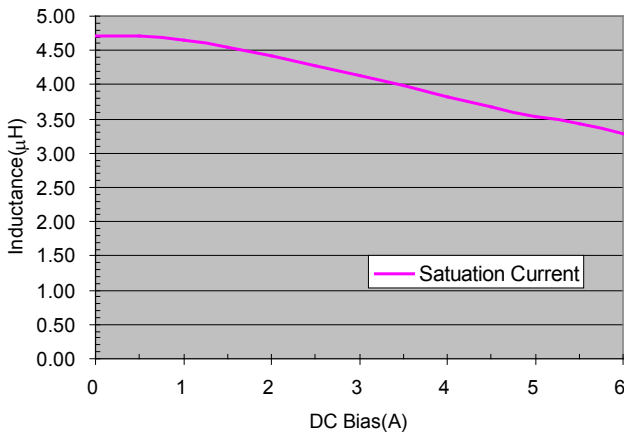

Molding Type Power Inductor

ASPI-0520LR



ELECTRICAL CHARACTERISTIC CURVES

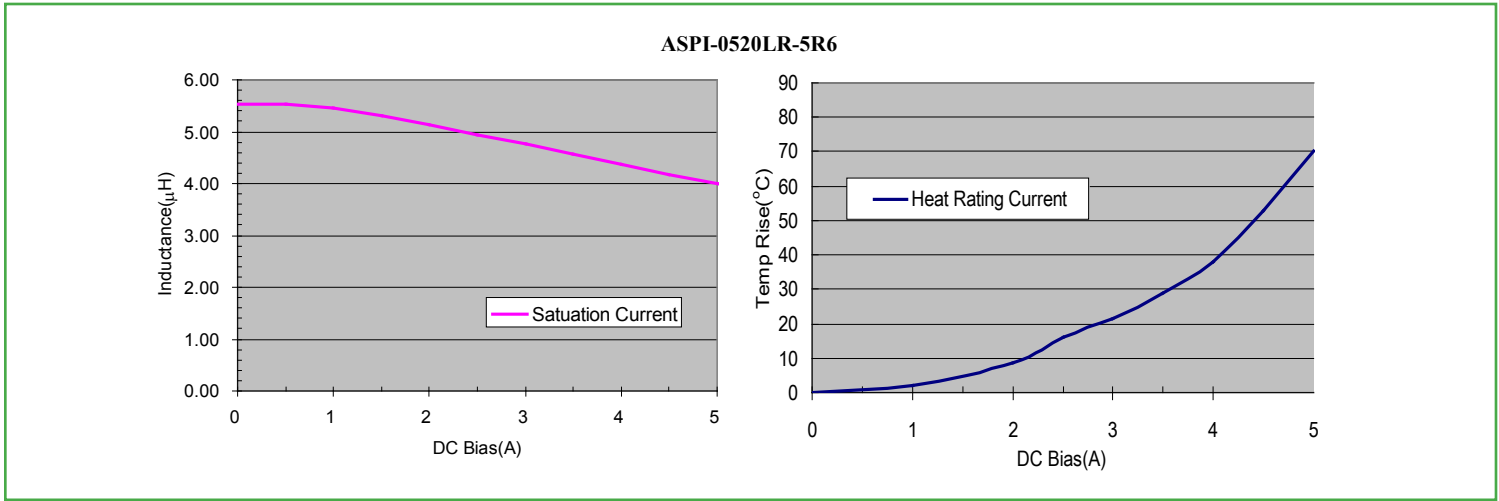

PART NUMBER IDENTIFICATION

ASPI-0520LR- -

Inductance Code
Please refer to the Electrical Spec Table

Tolerance
M: ±20%

Packaging
T2: Tape and Reel (2kpcs / reel)

OUTLINE DRAWING:

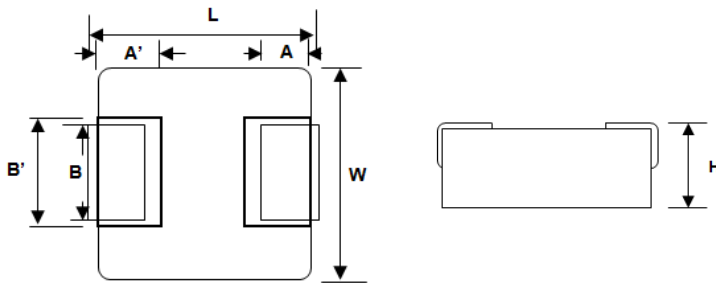

A	A'	B	B'	L	W	H
1.0 ±0.4	1.5 ±0.1	2.0 ±0.3	2.5 ±0.2	5.60 ±0.35	5.2 ±0.2	2.0 ±0.1

Recommended Land Pattern

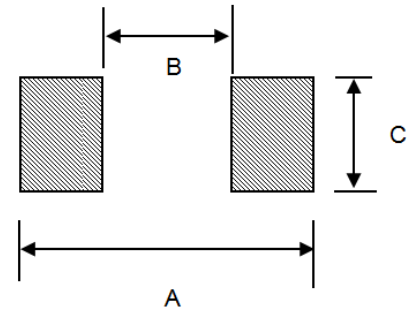

A	B	C
5.99	2.2	2.5

Dimension: mm

Molding Type Power Inductor

ASPI-0520LR



RoHS
Compliant



5.6 x 5.2 x 2.0 mm

TAPE & REEL:

T2: 2,000pcs / reel

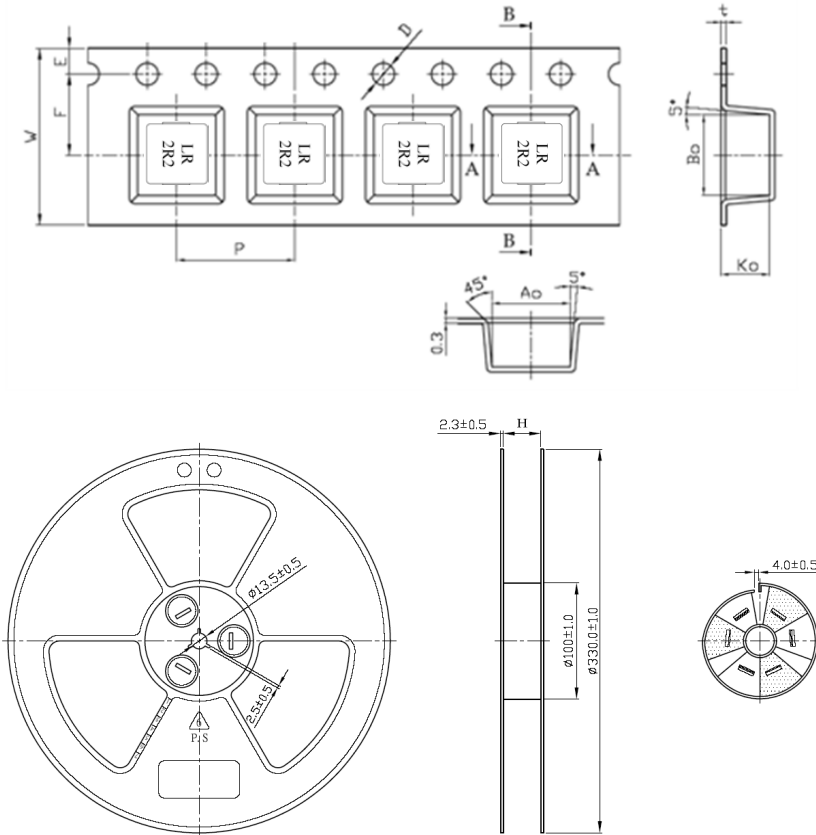

A0	5.3
B0	5.5
K0	3.3
P	8.0
t	0.4
W	12
E	1.75
F	5.5
D	1.5

Dimension: mm

REFLOW PROFILE:

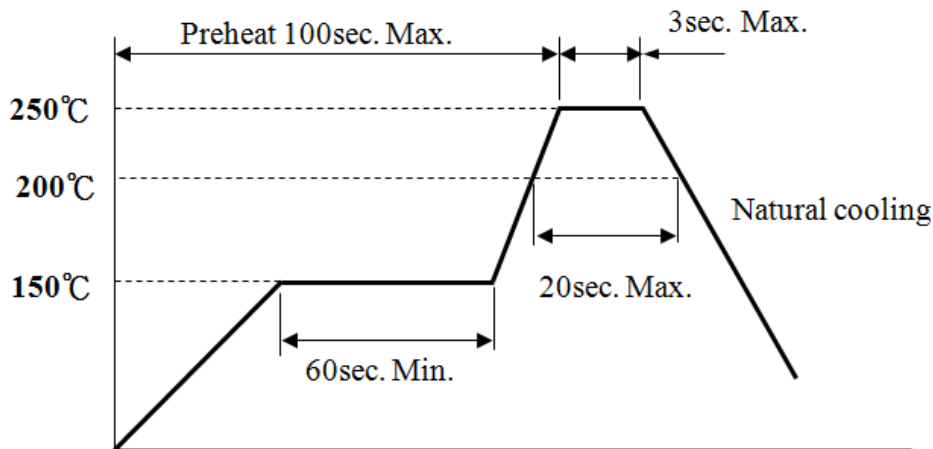

ATTENTION: Abracon Corporation's products are COTS – Commercial-Off-The-Shelf products; suitable for Commercial, Industrial and, where designated, Automotive Applications. Abracon's products are not specifically designed for Military, Aviation, Aerospace, Life-dependant Medical applications or any application requiring high reliability where component failure could result in loss of life and/or property. For applications requiring high reliability and/or presenting an extreme operating environment, written consent and authorization from Abracon Corporation is required. Please contact Abracon Corporation for more information.

ABRACON IS
ISO 9001:2008
CERTIFIED



Visit www.abracon.com for Terms & Conditions of Sale
30332 Esperanza, Rancho Santa Margarita, California 92688
tel 949-546-8000 | fax 949-546-8001 | www.abracon.com

Revised: 11.15.11