

SMD POWER INDUCTOR



15.24 x 18.54 x 7.11 mm

ASPI-1306T

 RoHS Compliant

FEATURES:

- Magnetic shielded for low radiation
- Low profile, compact size
- Large Terminal surface for good PCB bonding
- Low DCR, High Energy storage, suitable for large currents
- Ideal for a variety of DC-DC converter inductor applications

APPLICATIONS:

- Desktop, Laptop, servers
- Network hubs, bridges, routers
- Portable communication equipment
- OA equipment
- LCD, DVD, modem, set-top box
- DC/DC converters

ELECTRICAL SPECIFICATIONS:

| | |
|------------------------|------------------|
| Abracon P/N: | ASPI-1306T |
| Operating Temperature: | -40°C to +85°C |
| Storage Temperature: | : -40°C to +85°C |

Key Electrical Specifications at 25°C

| PART NUMBER | INDUCTANCE (uH) | Tolerance | SRF (MHz) max | RDC (Ω) max | Isat (A) max | Irms (A) max |
|----------------|-----------------|-----------|---------------|-------------|--------------|--------------|
| ASPI-1306T-1R0 | 1 | M | 80 | 0.009 | 20 | 8.6 |
| ASPI-1306T-2R2 | 2.2 | M | 80 | 0.014 | 16 | 7.1 |
| ASPI-1306T-3R3 | 3.3 | M | 60 | 0.015 | 14 | 6.2 |
| ASPI-1306T-4R7 | 4.7 | M | 60 | 0.018 | 13 | 6 |
| ASPI-1306T-5R6 | 5.6 | M | 40 | 0.02 | 12 | 5.3 |
| ASPI-1306T-8R2 | 8.2 | M | 30 | 0.029 | 10 | 4.8 |
| ASPI-1306T-100 | 10 | M | 30 | 0.031 | 10 | 4.3 |
| ASPI-1306T-150 | 15 | M | 22 | 0.036 | 8 | 4 |
| ASPI-1306T-220 | 22 | M | 20 | 0.047 | 7 | 3.5 |
| ASPI-1306T-330 | 33 | M | 15 | 0.066 | 5.5 | 3 |
| ASPI-1306T-470 | 47 | M | 9 | 0.086 | 4.5 | 2.6 |
| ASPI-1306T-680 | 68 | M | 8 | 0.13 | 3.5 | 2.3 |
| ASPI-1306T-750 | 75 | M | 8 | 0.152 | 3 | 2.3 |
| ASPI-1306T-101 | 100 | M | 7 | 0.19 | 3 | 1.8 |
| ASPI-1306T-151 | 150 | M | 6 | 0.25 | 2.6 | 1.5 |
| ASPI-1306T-221 | 220 | M | 5 | 0.38 | 2.4 | 1.2 |
| ASPI-1306T-331 | 330 | M | 4 | 0.56 | 1.9 | 1 |
| ASPI-1306T-471 | 470 | M | 3 | 0.85 | 1.4 | 0.82 |
| ASPI-1306T-681 | 680 | M | 2.5 | 1.10 | 1.2 | 0.72 |
| ASPI-1306T-102 | 1000 | M | 2 | 1.80 | 1 | 0.56 |

Test Conditions

Inductance: 100kHz, 0.1V

Isat: $\Delta L/L$ (initial) $\leq 10\%$

Irms: $\Delta T \leq 40^\circ\text{C}$

ABRACON IS
ISO 9001:2008
CERTIFIED



ABRACON
CORPORATION

Visit www.abracon.com for Terms & Conditions of Sale

30332 Esperanza, Rancho Santa Margarita, California 92688

tel 949-546-8000 | fax 949-546-8001 | www.abracon.com

Revised: 06.07.13

SMD POWER INDUCTOR



15.24 x 18.54 x 7.11 mm

ASPI-1306T

RoHS Compliant

OPTIONS AND PART IDENTIFICATION

ASPI-1306T - -

Inductance Code
Please refer to the table above

Tolerance %
M: ± 20%

Packaging
T: Tape and Reel
(500pcs / reel)

ELECTRICAL CHARACTERISTICS CURVES

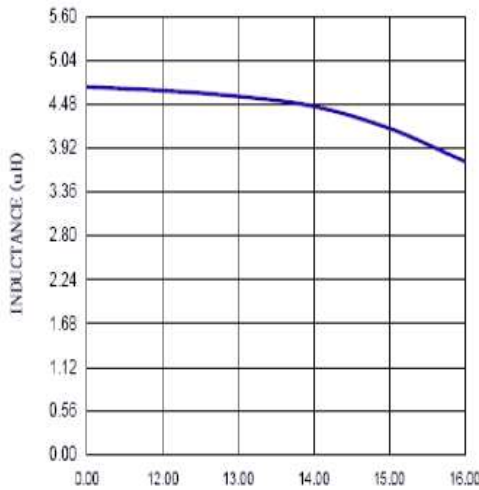

CURRENT (A)
ASPI-1306T-4R7M

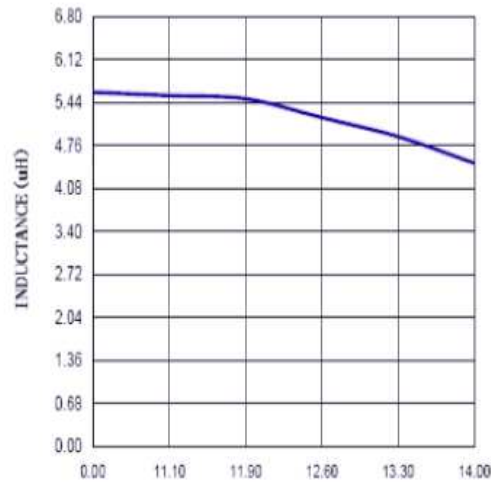

CURRENT (A)
ASPI-1306T-5R6M

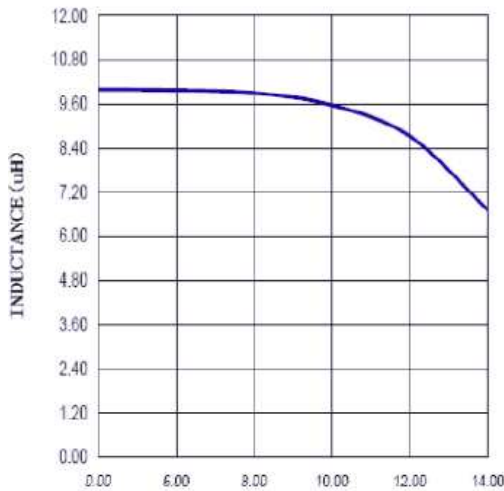

CURRENT (A)
ASPI-1306T-100M

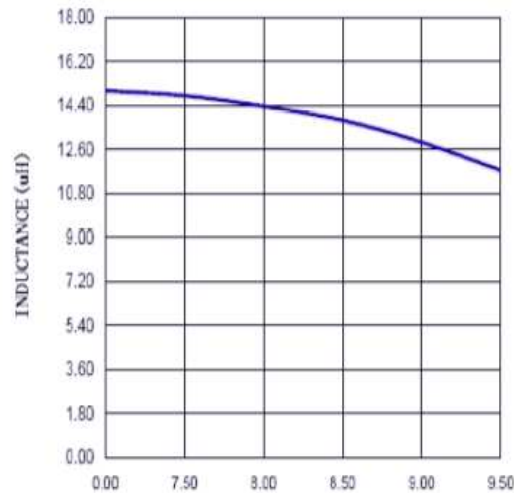

CURRENT (A)
ASPI-1306T-150M

ABRACON IS
ISO 9001:2008
CERTIFIED



Visit www.abracon.com for Terms & Conditions of Sale **Revised: 06.07.13**
30332 Esperanza, Rancho Santa Margarita, California 92688
tel 949-546-8000 | fax 949-546-8001 | www.abracon.com

SMD POWER INDUCTOR



15.24 x 18.54 x 7.11 mm

ASPI-1306T

RoHS Compliant

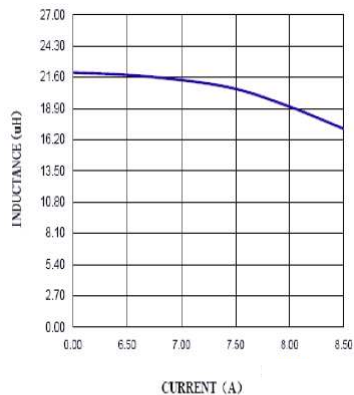

ASPI-1306T-220M

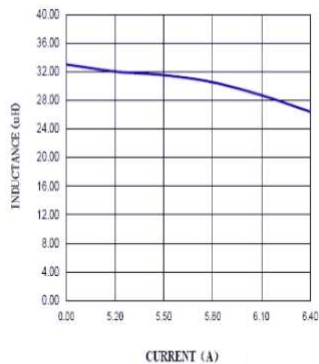

ASPI-1306T-330M

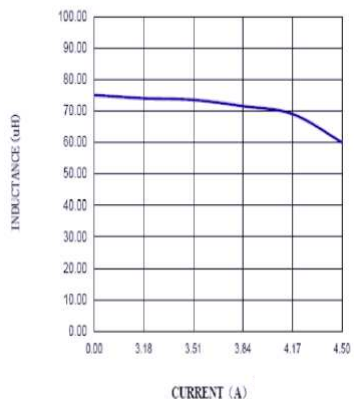

ASPI-1306T-750M

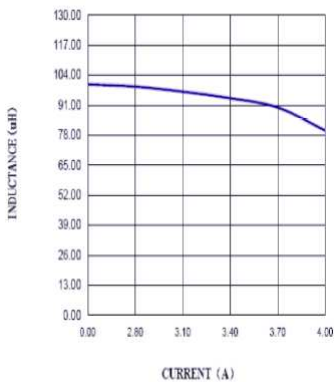

ASPI-1306T-101M

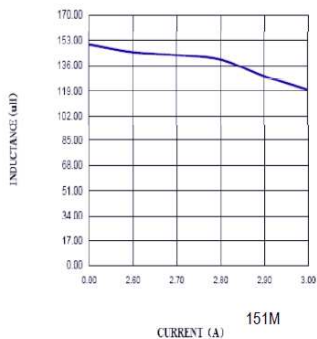

ASPI-1306T-151M

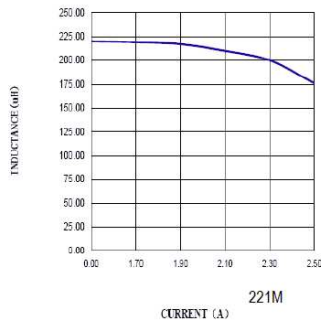

ASPI-1306T-221M

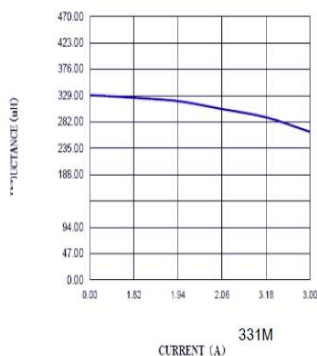

ASPI-1306T-331M

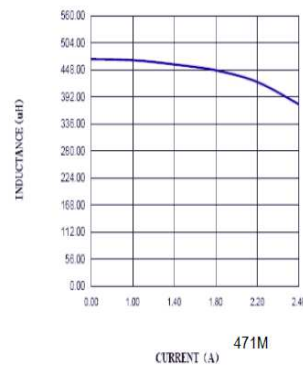

ASPI-1306T-471M

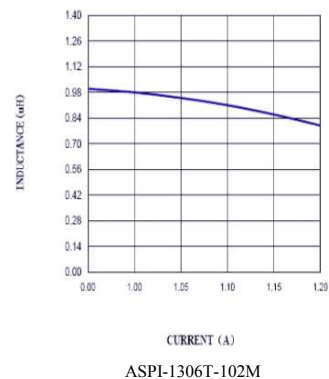

ASPI-1306T-102M

ABRACON IS
ISO 9001:2008
CERTIFIED

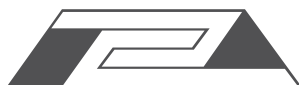

ABRACON
CORPORATION

Visit www.abracon.com for Terms & Conditions of Sale **Revised: 06.07.13**
30332 Esperanza, Rancho Santa Margarita, California 92688
tel 949-546-8000 | fax 949-546-8001 | www.abracon.com

SMD POWER INDUCTOR



15.24 x 18.54 x 7.11 mm

ASPI-1306T

RoHS Compliant

OUTLINE DIMENSION:

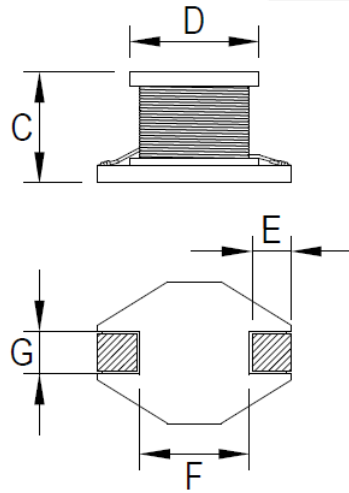
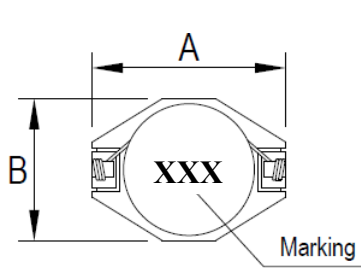

Recommended Land Pattern

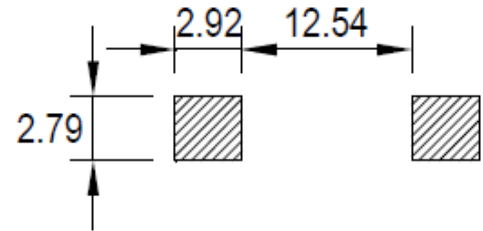

| | DIM. | TOL. |
|---|-------|------|
| A | 18.54 | Max. |
| B | 15.24 | Max. |
| C | 7.11 | Max. |
| D | 12.70 | ±0.3 |
| E | 2.54 | ±0.3 |
| F | 12.70 | ±0.3 |
| G | 2.54 | ±0.3 |

Dimension: mm

REFLOW PROFILE:

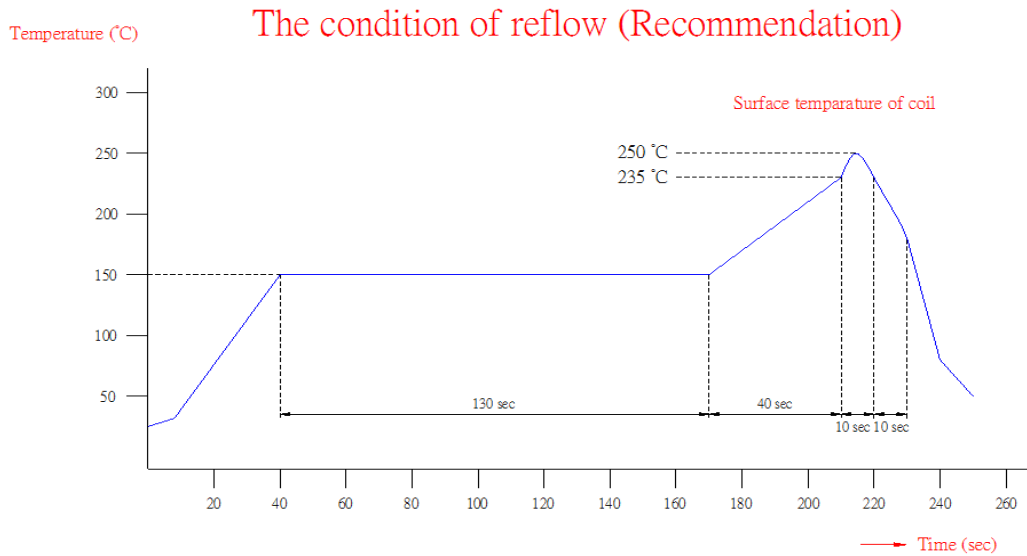

SMD POWER INDUCTOR



15.24 x 18.54 x 7.11 mm

ASPI-1306T

RoHS Compliant

TAPE & REEL

T: 500pcs / reel

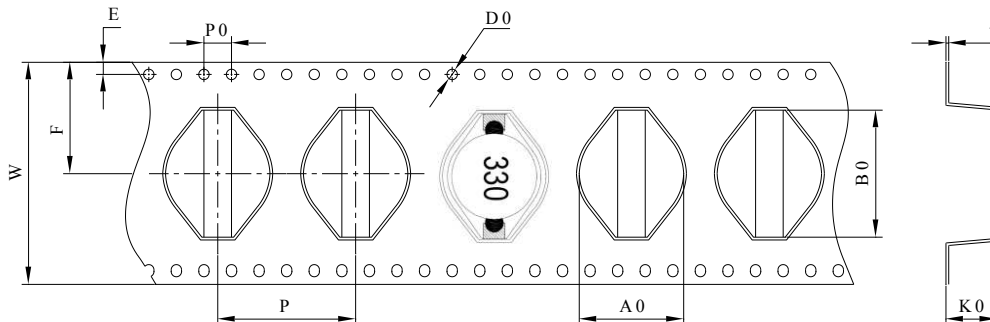

| W | E | F | P | A0 | B0 | D0 | P0 | K0 | t |
|--------|----------|-----------|----------|----------|----------|---------|---------|---------|----------|
| 32±0.3 | 1.75±0.1 | 16.25±0.1 | 20.0±0.1 | 15.5±0.1 | 19.5±0.1 | 1.5±0.1 | 4.0±0.1 | 7.1±0.1 | 0.3±0.05 |

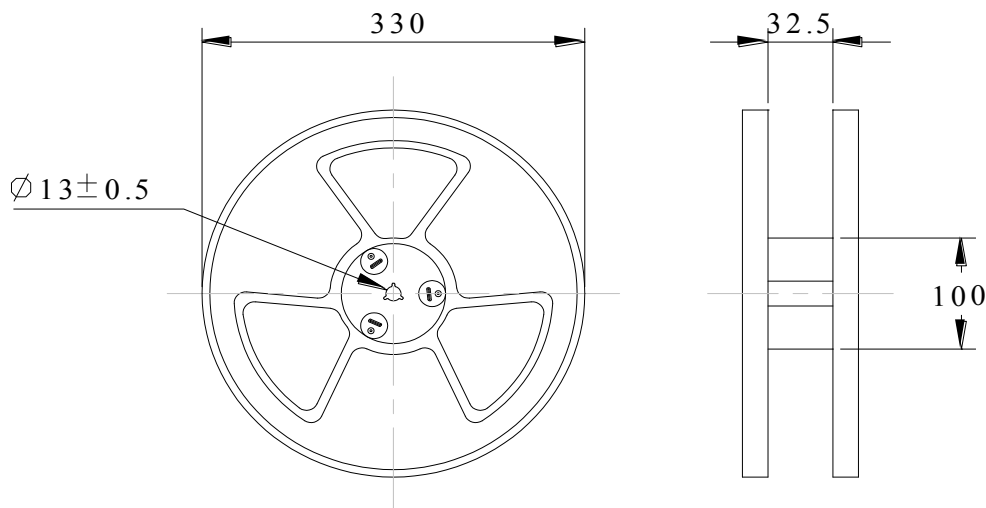

Dimension: mm

ATTENTION: Abracon Corporation's products are COTS – Commercial-Off-The-Shelf products; suitable for Commercial, Industrial and, where designated, Automotive Applications. Abracon's products are not specifically designed for Military, Aviation, Aerospace, Life-dependant Medical applications or any application requiring high reliability where component failure could result in loss of life and/or property. For applications requiring high reliability and/or presenting an extreme operating environment, written consent and authorization from Abracon Corporation is required. Please contact Abracon Corporation for more information.

ABRACON IS
ISO 9001:2008
CERTIFIED



Visit www.abracon.com for Terms & Conditions of Sale **Revised: 06.07.13**
30332 Esperanza, Rancho Santa Margarita, California 92688
tel 949-546-8000 | fax 949-546-8001 | www.abracon.com