

32.768kHz SMD LOW PROFILE CRYSTAL

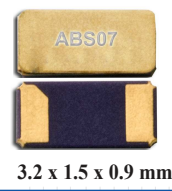

3.2 x 1.5 x 0.9 mm

ABS07

Moisture Sensitivity Level (MSL) – This product is Hermetically Sealed and not Moisture Sensitive - MSL = N/A: Not Applicable



RoHS/RoHS II

➤ **FEATURES:**

- Low frequency in small size SMD
- 0.9mm height ideal for high density circuit boards
- Seam sealed ceramic package offers excellent environmental & heat resistance
- Extended temperature -40°C to +85°C for industrial applications

➤ **APPLICATIONS:**

- Wide range in communication & measuring equipment
- Commercial & Industrial applications
- Wireless communications
- PDA and Smartphone

➤ **STANDARD SPECIFICATIONS**

Parameters	Minimum	Typical	Maximum	Units	Notes
Frequency		32.768		kHz	
Operation Mode	Flexural Mode (Tuning Fork)				
Operating Temperature	-40	-----	+85	°C	
Storage Temperature	-55	-----	+125	°C	
Frequency Tolerance @+25°C	-20	-----	+20	ppm	See options
Temperature Coefficient:	-0.040	-0.036	-----	ppm/T ²	
Turn-over temperature:	+20	+25	+30	°C	
Equivalent series resistance (R1)	-----	-----	70	kΩ	
Shunt capacitance (C0)	-----	0.9 ~ 1.2	-----	pF	
Load capacitance (CL)	-----	12.5	-----	pF	See options
Drive Level	-----	0.1	0.5	μW	
Q value	10000	30000	-----	-----	
Aging@25°C±3°C	-3	-----	3	ppm	First year
Insulation Resistance	500	-----	-----	MΩ	@ 100Vdc ± 15V

➤ **OPTIONS AND PART IDENTIFICATION (left blank if standard)**

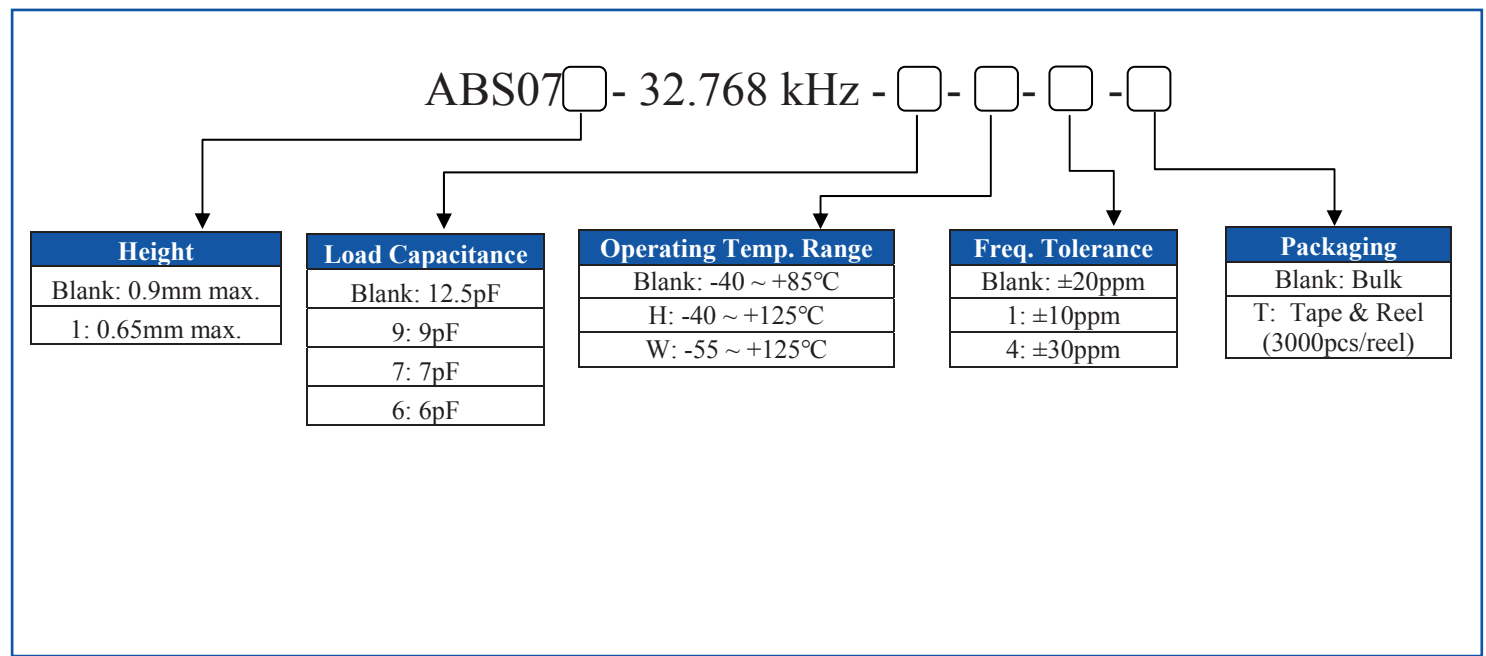

32.768kHz SMD LOW PROFILE CRYSTAL

ABS07

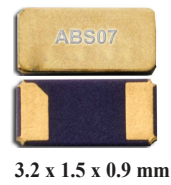

FREQUENCY VS. TEMPERATURE CHARACTERISTICS

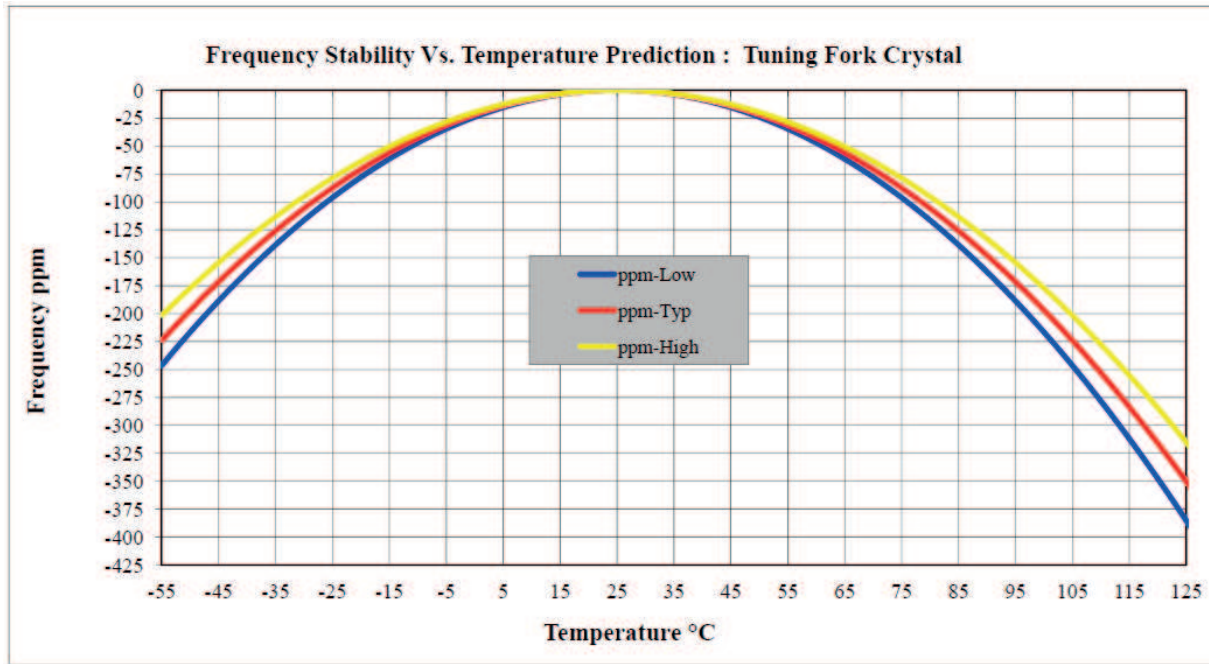

OUTLINE DIMENSIONS:

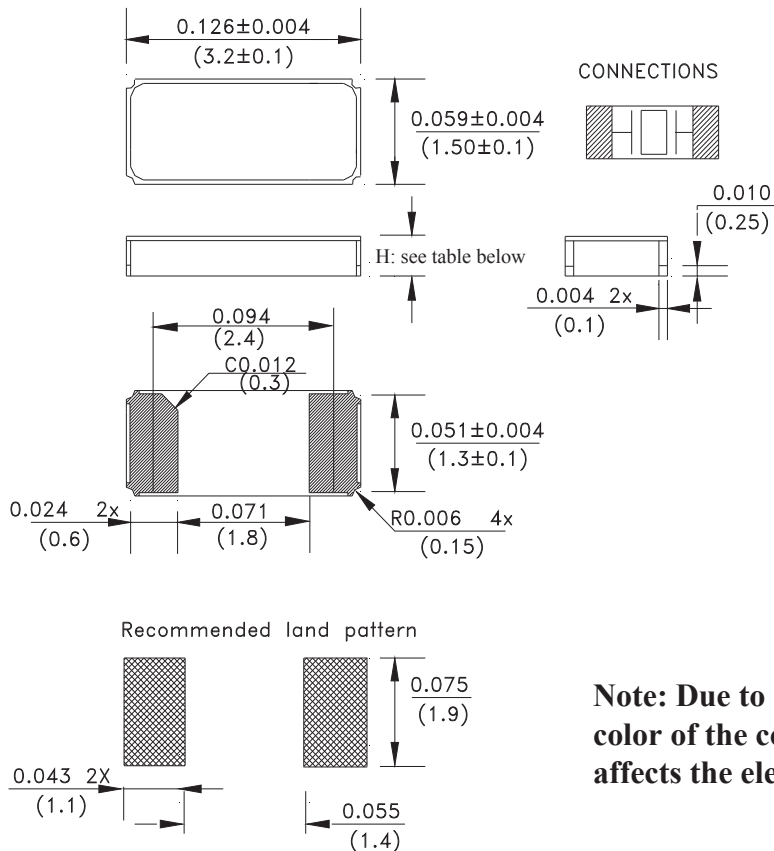

Part Number	Height (H)
ABS07	0.9 mm max.
ABS071	0.65 mm max.

Note: Due to material availability, the outline and finish color of the component may vary. This variation in no way affects the electrical performance of the product.

Dimensions: inches (mm)

32.768kHz SMD LOW PROFILE CRYSTAL

ABS07



RoHS/RoHS II



3.2 x 1.5 x 0.9 mm

REFLOW PROFILE

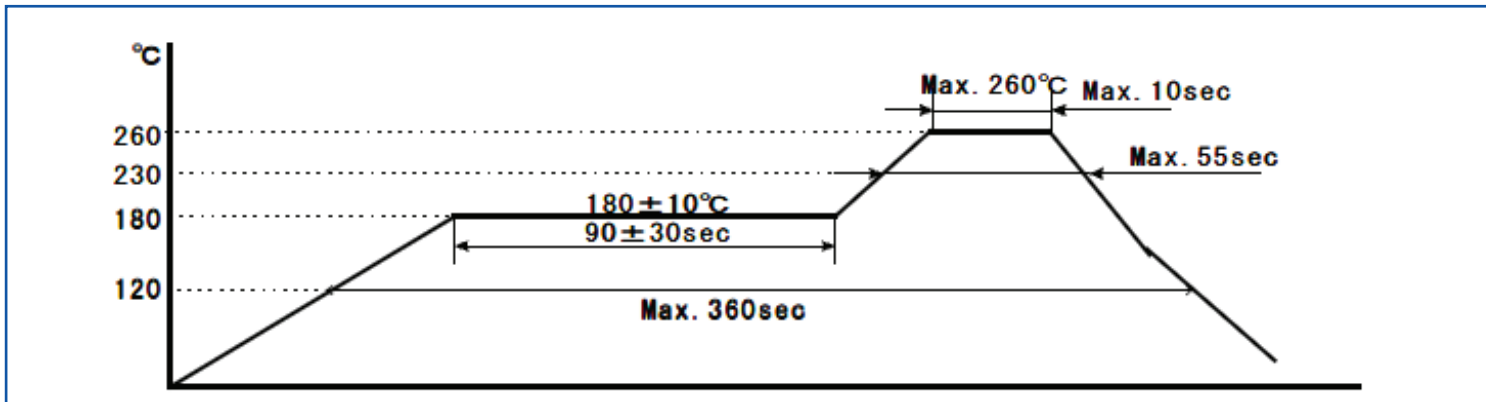

TAPE & REEL

T=Tape and reel (3,000pcs/reel)

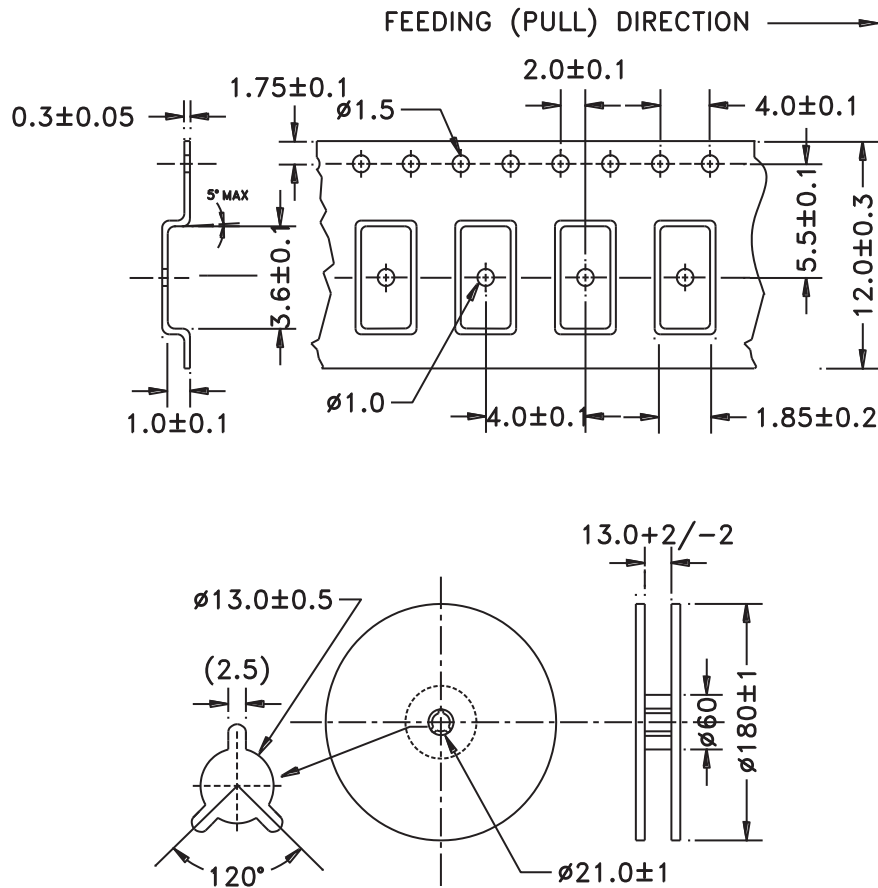

Dimensions: mm

ATTENTION: Abracon Corporation's products are COTS – Commercial-Off-The-Shelf products; suitable for Commercial, Industrial and, where designated, Automotive Applications. Abracon's products are not specifically designed for Military, Aviation, Aerospace, Life-dependant Medical applications or any application requiring high reliability where component failure could result in loss of life and/or property. For applications requiring high reliability and/or presenting an extreme operating environment, written consent and authorization from Abracon Corporation is required. Please contact Abracon Corporation for more information.

ABRACON IS
ISO9001:2008
CERTIFIED



Visit www.abracon.com for Terms & Conditions of Sale **Revised: 04.03.13**
30332 Esperanza, Rancho Santa Margarita, California 92688
tel 949-546-8000 | fax 949-546-8001 | www.abracon.com