

SMD Schottky Barrier Diode

CDBER42/43-HF

$I_o = 200 \text{ mA}$
 $V_R = 30 \text{ Volts}$
RoHS Device
Halogen Free

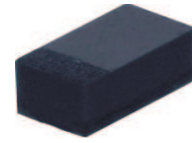

Features

- Low forward voltage.
- Designed for mounting on small surface.
- Extremely thin/leadless package.
- Majority carrier conduction.

Mechanical data

- Case: 0503(1308) standard package, molded plastic.
- Terminals: Gold plated, solderable per MIL-STD-750, method 2026.
- Marking code:
 CDBER42-HF : BD
 CDBER43-HF : BE
- Mounting position: Any
- Weight: 0.002 gram(approx.).

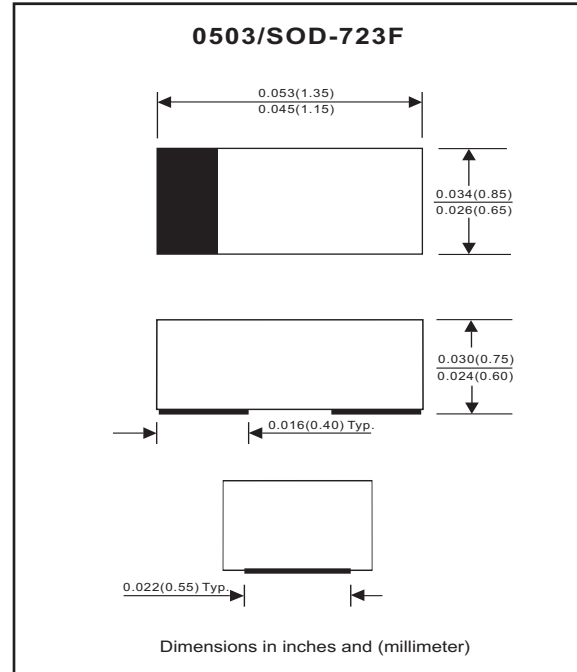

Maximum Rating (at TA=25°C unless otherwise noted)

Parameter	Conditions	Symbol	Min	Typ	Max	Unit
Peak reverse voltage		V_{RM}			30	V
Reverse voltage		V_R			30	V
RMS reverse voltage		$V_{R(RMS)}$			21	V
Average forward rectified current		I_o			200	mA
Repetitive peak forward current		I_{FRM}			0.5	A
Forward current,surge peak	8.3 ms single half sine-wave superimposed on rate load(JEDEC method)	I_{FSM}			4	A
Power dissipation		P_D			150	mW
Thermal resistance junction to ambient air		$R_{\theta JA}$			667	°C/W
Storage temperature		T_{STG}	-55		+125	°C
Junction temperature		T_j			+125	°C

Electrical Characteristics (at TA=25°C unless otherwise noted)

Parameter	Conditions	Symbol	Min	Typ	Max	Unit
Forward voltage CDBER42/43-HF CDBER42-HF CDBER42-HF CDBER43-HF CDBER43-HF	$I_F = 200\text{mA}$ $I_F = 10\text{mA}$ $I_F = 50\text{mA}$ $I_F = 2\text{mA}$ $I_F = 15\text{mA}$	V_F			1 0.4 0.65 0.33 0.45	V
Reverse current	$V_R = 25\text{V}$	I_R			0.5	uA
Capacitance between terminals	$f = 1 \text{ MHz}$, and 1 VDC reverse voltage	C_T			10	pF
Reverse recovery time	$I_F=I_R=10\text{mA}$, $I_{rr}=0.1 \times I_R$, $R_L=100 \text{ ohm}$	T_{rr}			5	nS

RATING AND CHARACTERISTIC CURVES (CDBER42/43-HF)

Fig. 1 - Forward characteristics

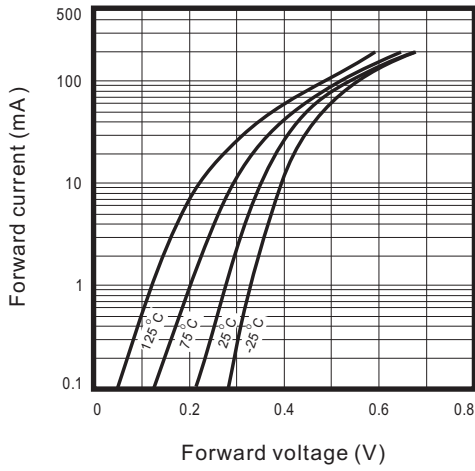

Fig. 2 - Reverse characteristics

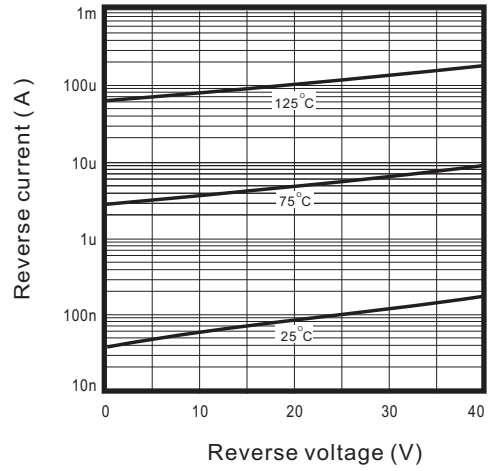

Fig.3 - Capacitance between terminals characteristics

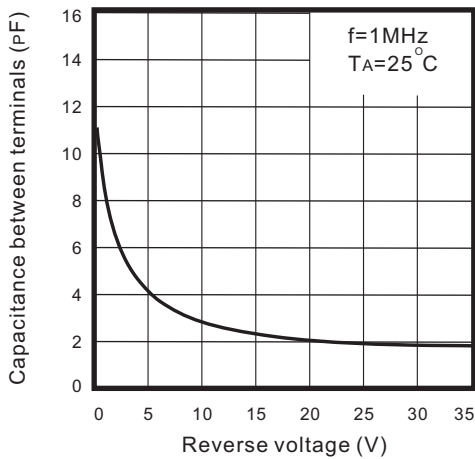
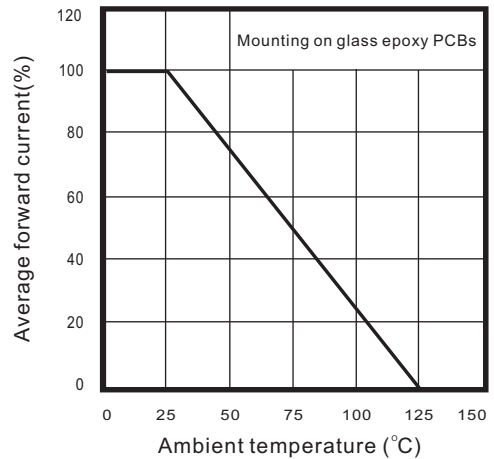
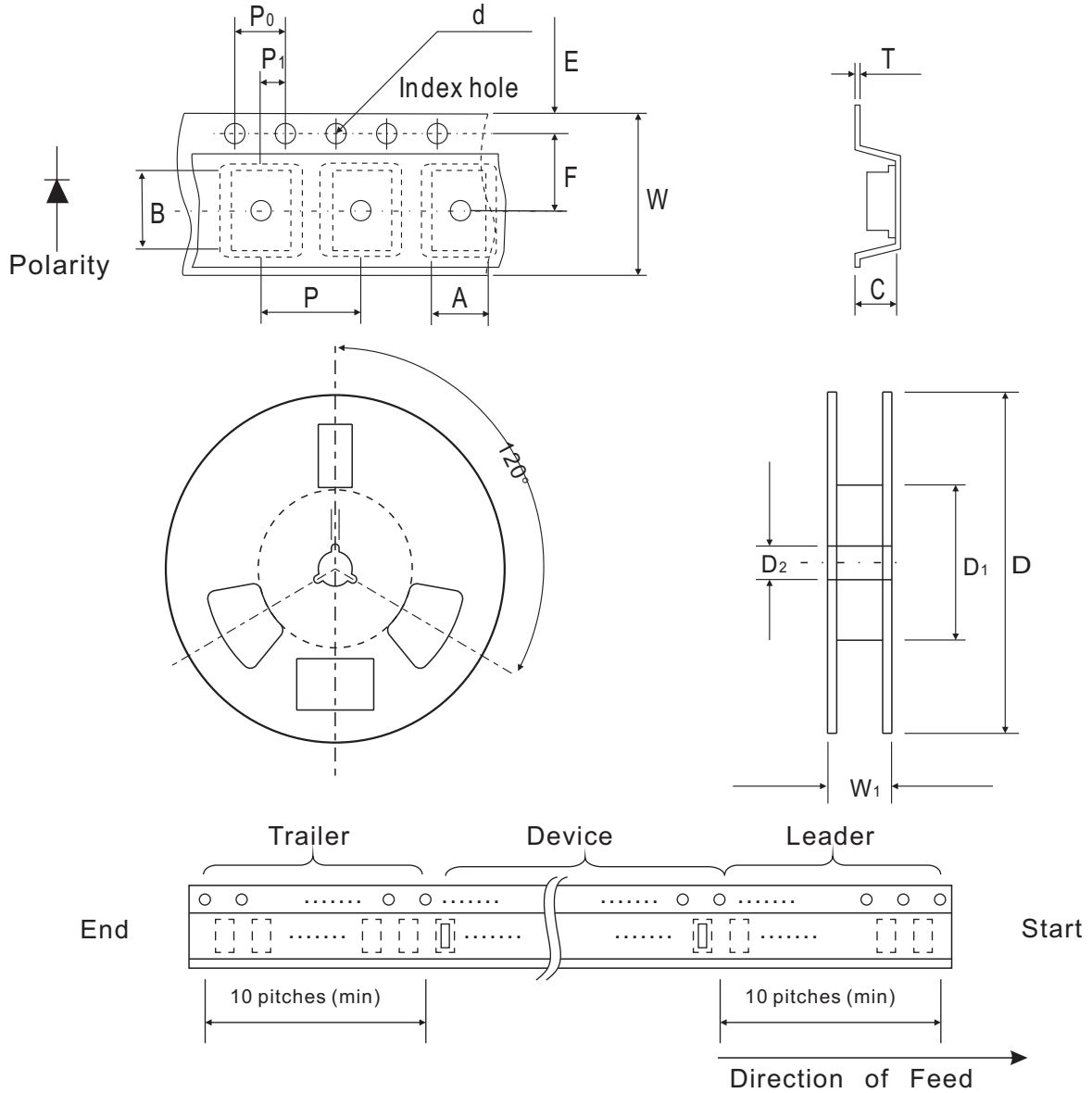

Fig.4 - Current derating curve



Reel Taping Specification



0503 (SOD-723F)	SYMBOL	A	B	C	d	D	D ₁	D ₂
	(mm)	0.90 ± 0.10	1.46 ± 0.10	0.80 ± 0.10	1.55 ± 0.05	178 ± 1	60.0 MIN.	13.0 ± 0.20
	(inch)	0.035 ± 0.004	0.057 ± 0.004	0.031 ± 0.004	0.061 ± 0.002	7.008 ± 0.04	2.362 MIN.	0.512 ± 0.008

0503 (SOD-723F)	SYMBOL	E	F	P	P ₀	P ₁	T	W	W ₁
	(mm)	1.75 ± 0.10	3.50 ± 0.05	4.00 ± 0.10	4.00 ± 0.10	2.00 ± 0.10	0.22 ± 0.05	8.00 ± 0.20	13.5 MAX.
	(inch)	0.069 ± 0.004	0.138 ± 0.002	0.157 ± 0.004	0.157 ± 0.004	0.079 ± 0.004	0.008 ± 0.002	0.315 ± 0.008	0.531 MAX.

Marking Code

Part Number	Marking Code
CDBER42-HF	BD
CDBER43-HF	BE



xx = Product type marking code

Suggested PAD Layout

SIZE	0503/SOD-723F	
	(mm)	(inch)
A	0.85	0.033
B	0.55	0.022
C	0.85	0.033
D	1.40	0.055
E	0.30	0.012

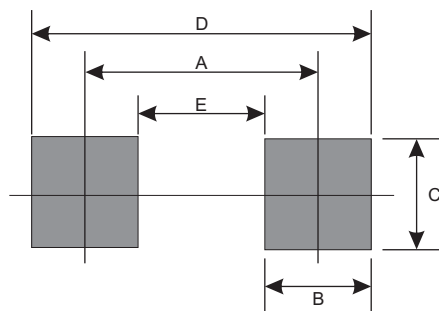

Standard Package

Case Type	Qty per Reel	Reel Size
	(Pcs)	(inch)
0503/SOD-723F	4000	7