

## CDSER400B

### RoHS Device

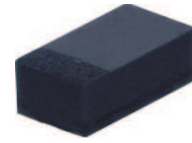

### Features

- High Speed.
- Designed for mounting on small surface.
- Extremely thin/leadless package.
- Low leakage current.
- High mounting capability, strong surge withstand, high reliability.

### Mechanical data

- Case: 0503/SOD-723F standard package, molded plastic.
- Terminals: Gold plated, solderable per MIL-STD-750, method 2026.
- Polarity: Indicated by cathode band.
- Mounting position: Any
- Weight: 0.002 gram(approx.).

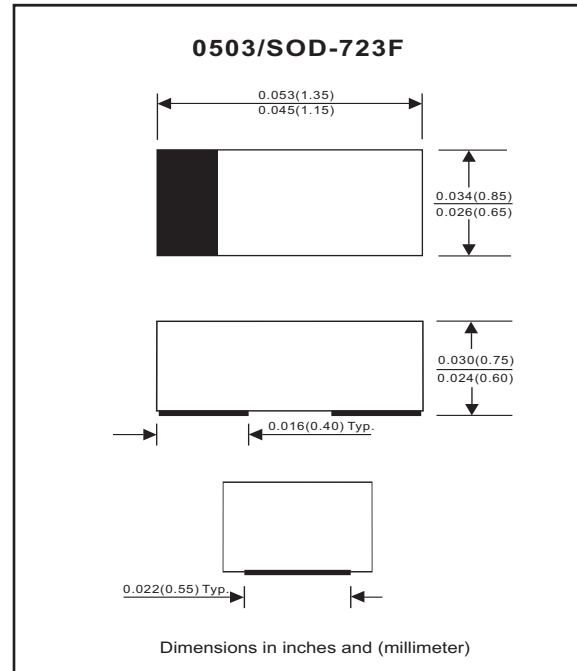

### Maximum Rating (at TA=25°C unless otherwise noted)

Parameter	Conditions	Symbol	Min	Typ	Max	Unit
Repetitive peak reverse voltage		V <sub>RRM</sub>			90	V
Reverse voltage		V <sub>R</sub>			80	V
Average forward current		I <sub>O</sub>			100	mA
Forward current, surge peak	8.3 ms single half sine-wave superimposed on rate load ( JEDEC method)	I <sub>FSM</sub>		1000		mA
Repetitive peak forward current		I <sub>FRM</sub>			225	mA
Power Dissipation		P <sub>D</sub>			150	mW
Storage temperature		T <sub>STG</sub>	-55		+125	°C
Junction temperature		T <sub>j</sub>			+125	°C

### Electrical Characteristics (at TA=25°C unless otherwise noted)

Parameter	Conditions	Symbol	Min	Typ	Max	Unit
Forward voltage	I <sub>F</sub> = 100 mA DC	V <sub>F</sub>			1.0	V
Reverse current	V <sub>R</sub> = 80 V	I <sub>R</sub>			0.1	uA
Capacitance between terminals	f = 1 MHz, and 0.5VDC reverse voltage	C <sub>T</sub>			3	pF
Reverse recovery time	V <sub>R</sub> = 6V , I <sub>F</sub> = 10 mA, R <sub>L</sub> = 50 ohms	T <sub>rr</sub>			4	nS

## RATING AND CHARACTERISTIC CURVES (CDSER400B )

Fig. 1 - Forward characteristics

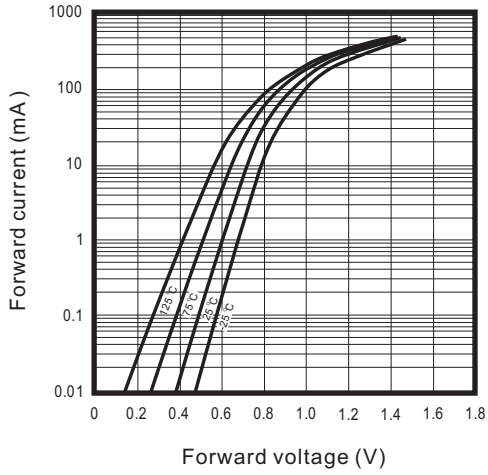

Fig. 2 - Reverse characteristics

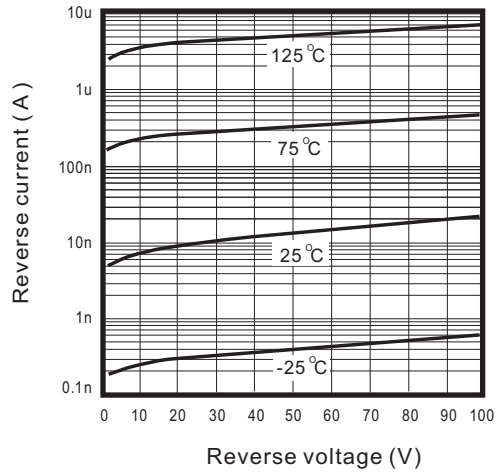

Fig. 3 - Capacitance between terminals characteristics

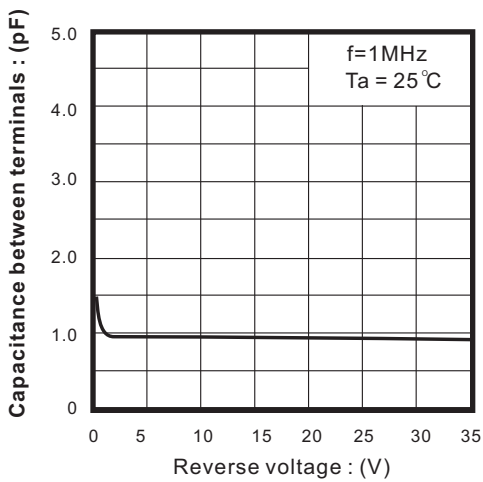
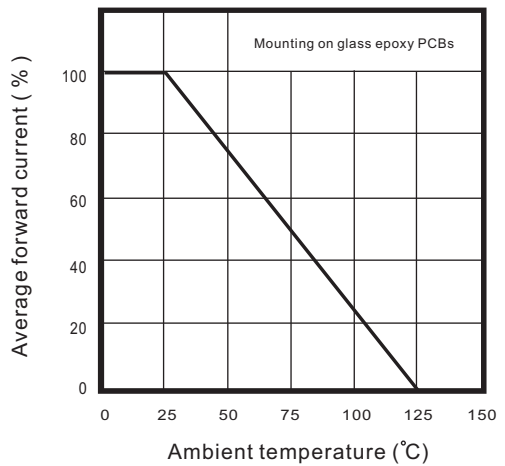
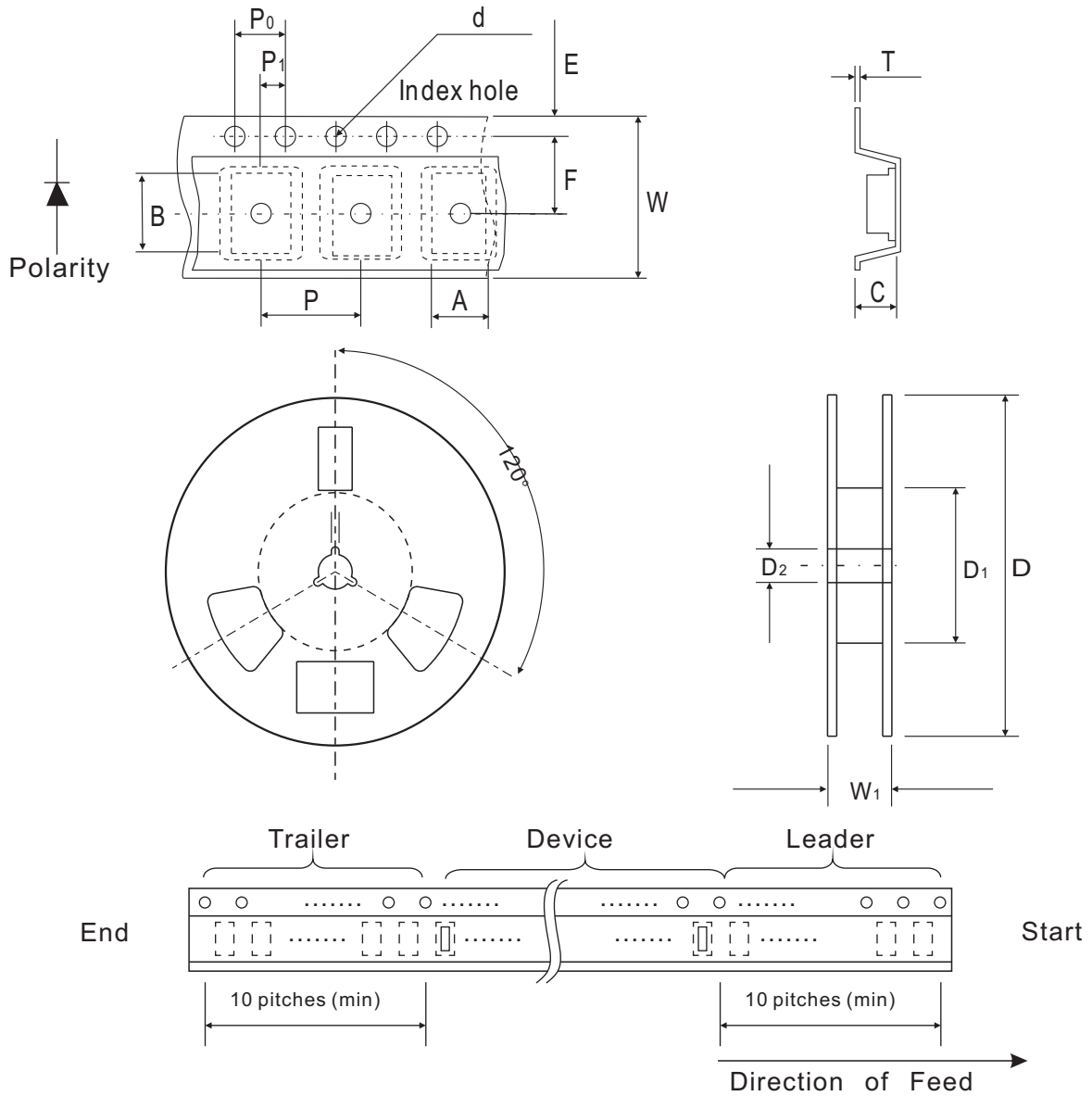

Fig. 4 - Current derating curve



## Reel Taping Specification



0503 (SOD-723F)	SYMBOL	A	B	C	d	D	D <sub>1</sub>	D <sub>2</sub>
	(mm)	0.90 ± 0.10	1.46 ± 0.10	0.80 ± 0.10	1.55 ± 0.05	178 ± 1	60.0 MIN.	13.0 ± 0.20
	(inch)	0.035 ± 0.004	0.057 ± 0.004	0.031 ± 0.004	0.061 ± 0.002	7.008 ± 0.04	2.362 MIN.	0.512 ± 0.008

0503 (SOD-723F)	SYMBOL	E	F	P	P <sub>0</sub>	P <sub>1</sub>	T	W	W <sub>1</sub>
	(mm)	1.75 ± 0.10	3.50 ± 0.05	4.00 ± 0.10	4.00 ± 0.10	2.00 ± 0.10	0.22 ± 0.05	8.00 ± 0.20	13.5 MAX.
	(inch)	0.069 ± 0.004	0.138 ± 0.002	0.157 ± 0.004	0.157 ± 0.004	0.079 ± 0.004	0.008 ± 0.002	0.315 ± 0.008	0.531 MAX.

## Marking Code

Part Number	Marking Code
CDSER400B	S4



## Suggested PAD Layout

SIZE	0503/SOD-723F	
	(mm)	(inch)
A	0.85	0.033
B	0.55	0.022
C	0.85	0.033
D	1.40	0.055
E	0.30	0.012

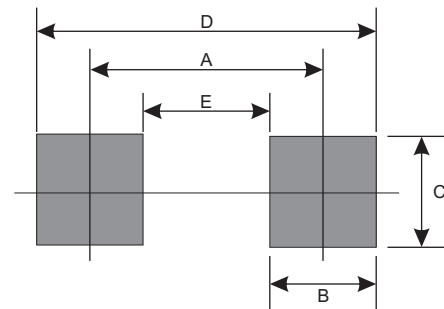

## Standard Package

Case Type	Qty per Reel	Reel Size
	(Pcs)	(inch)
0503/SOD-723F	4000	7