

## CPDT5-5V0

RoHS Device

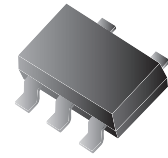

### Features

- Common anode ESD protection.
- IEC61000-4-2 Level 4 ESD protection.
- Low operating voltage: < 5V.
- Fast turn-on and low clamping voltage.

### Mechanical data

- Case: SOT-23-5 Standard package, molded plastic.
- Terminals: Tin plated, solderable per MIL-STD-750, method 2026.
- Marking code:E05
- Mounting position: Any.
- Weight: 0.0153 gram(approx.).

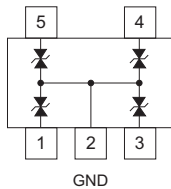
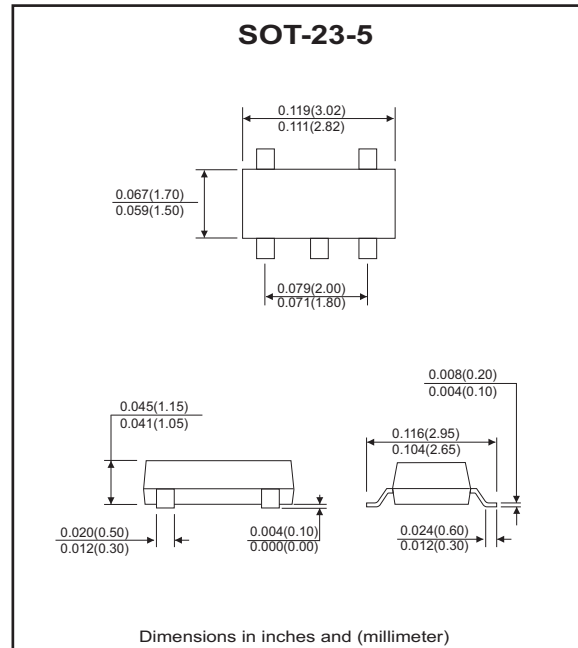

### Electrical Characteristics (at TA=25°C unless otherwise noted)

| Parameter               | Conditions                                   | Symbol           | Min | Typ | Max     | Unit |
|-------------------------|--|------------------|-----|-----|---------|------|
| Diode breakdown voltage | I <sub>R</sub> = 1mA                         | V <sub>BD</sub>  | 5.1 | 7.0 |         | V    |
| Leakage current         | V <sub>R</sub> = 5V                          | I <sub>L</sub>   |     | 0.1 | 2.0     | uA   |
| Junction capacitance    | V <sub>R</sub> = 0V, f = 1MHz                | C <sub>T</sub>   |     | 15  | 20      | pF   |
| ESD capability          | IEC 61000-4-2(air)<br>IEC 61000-4-2(contact) | ESD              |     |     | 16<br>8 | kV   |
| Clamping voltage        | I <sub>PP</sub> = 5A, T <sub>P</sub> =8/20us | V <sub>C</sub>   |     |     | 15      | V    |
| Peak pulse power        | T <sub>P</sub> =8/20us                       | P <sub>PP</sub>  |     |     | 75      | W    |
| Operation temperature   |  | T <sub>j</sub>   |     |     | 125     | °C   |
| Storage temperature     |  | T <sub>STG</sub> | -55 |     | 150     | °C   |

## RATING AND CHARACTERISTIC CURVES (CPDT5-5V0)

Fig. 1 - 8/20us Peak pulse current waveform acc. IEC 61000-4-5

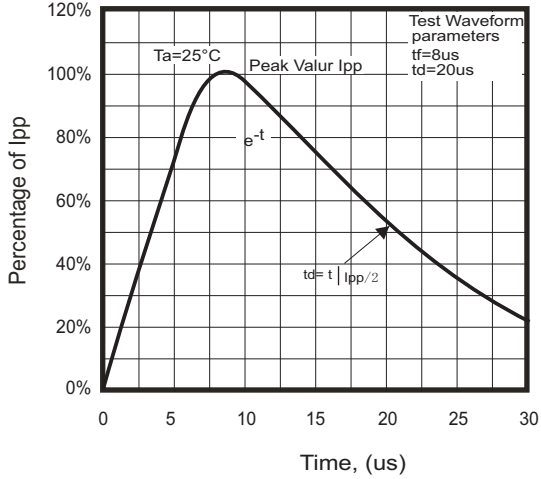

Fig. 2 - Reverse characteristics

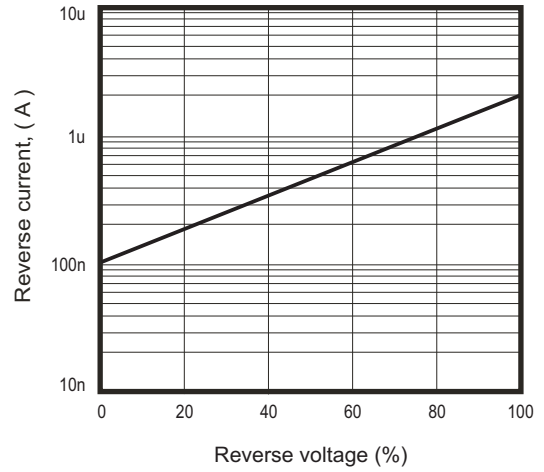

Fig.3 - Capacitance between terminals characteristics

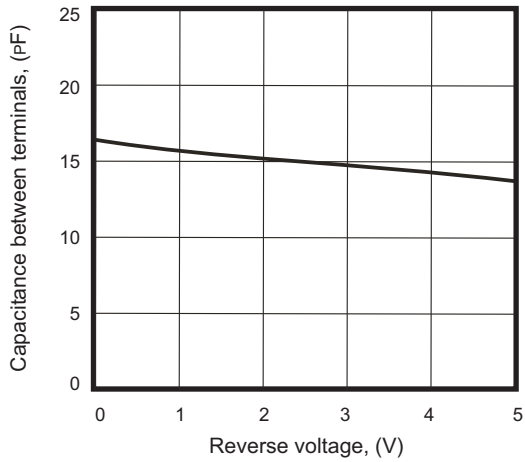
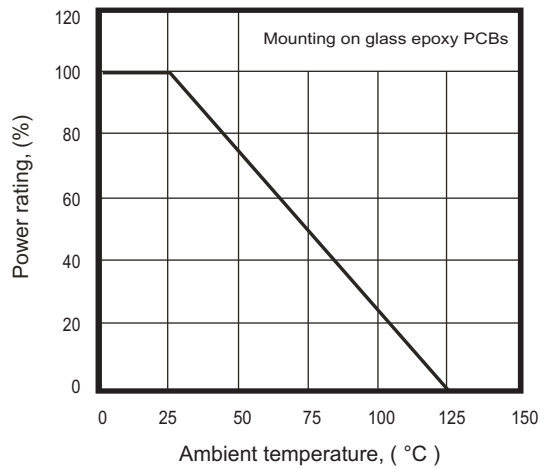
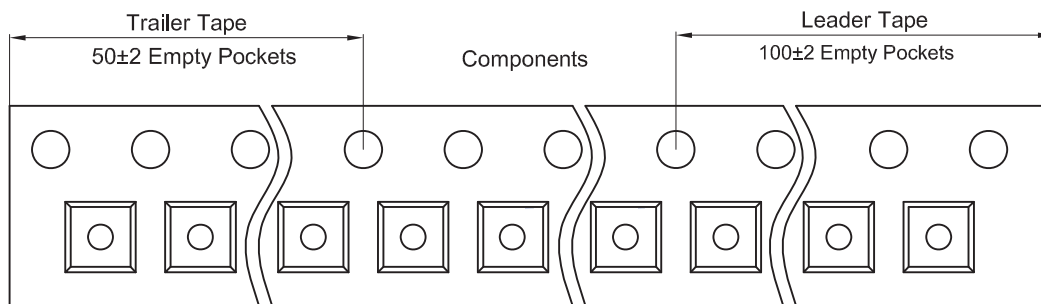
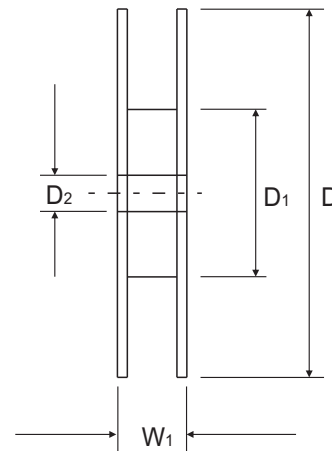
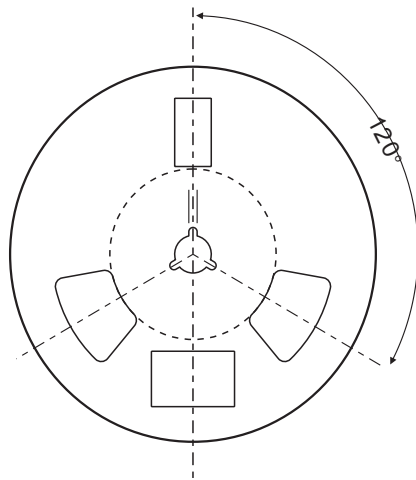
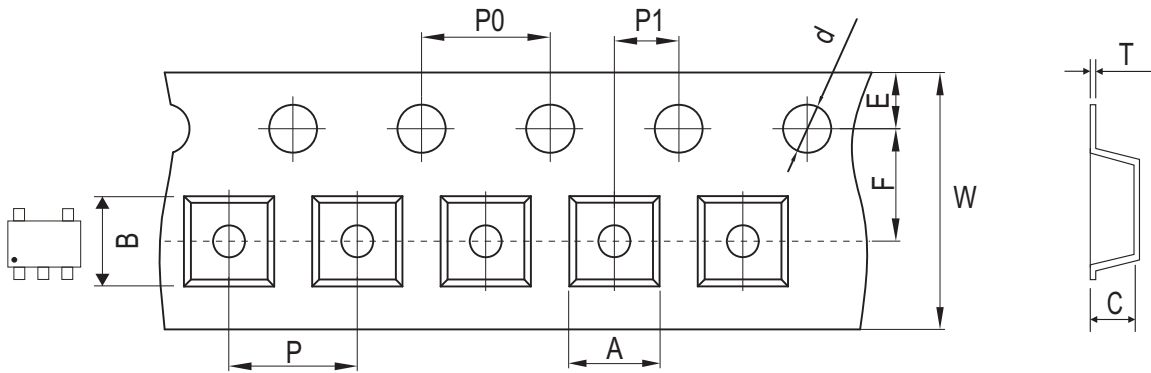

Fig.4 - Power rating derating curve



## Reel Taping Specification



| SOT-23-5 | SYMBOL | A             | B             | C             | d             | D                      | D1            | D2            |
|----------|--------|---------------|---------------|---------------|---------------|------------------------|---------------|---------------|
|          | (mm)   | 3.17 ± 0.10   | 3.23 ± 0.10   | 1.37 ± 0.10   | 1.50 ± 0.05   | 180.0 + 0.00 / - 0.30  | 60.00 ± 0.50  | 13.00 ± 0.20  |
|          | (inch) | 0.125 ± 0.004 | 0.127 ± 0.004 | 0.054 ± 0.004 | 0.059 ± 0.002 | 7.087 + 0.00 / - 0.012 | 2.362 ± 0.020 | 0.512 ± 0.008 |

| SOT-23-5 | SYMBOL | E             | F             | P             | P0            | P1            | W                       | W1            |
|----------|--------|---------------|---------------|---------------|---------------|---------------|-------------------------|---------------|
|          | (mm)   | 1.75 ± 0.10   | 3.50 ± 0.05   | 4.00 ± 0.10   | 4.00 ± 0.10   | 2.00 ± 0.05   | 8.00 + 0.30 / - 0.10    | 12.30 ± 0.20  |
|          | (inch) | 0.069 ± 0.004 | 0.138 ± 0.002 | 0.157 ± 0.004 | 0.157 ± 0.004 | 0.079 ± 0.002 | 0.315 + 0.012 / - 0.004 | 0.484 ± 0.008 |

## Marking Code

| Part Number | Marking Code |
|-------------|--------------|
| CPDT5-5V0   | E05          |

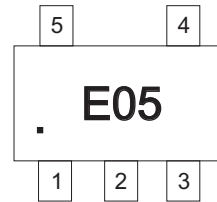

## Suggested PAD Layout

| SIZE | SOT-23-5 |        |
|------|----------|--------|
|      | (mm)     | (inch) |
| A    | 1.10     | 0.043  |
| B    | 0.60     | 0.024  |
| C    | 1.90     | 0.075  |
| D    | 2.50     | 0.098  |
| E    | 3.60     | 0.142  |

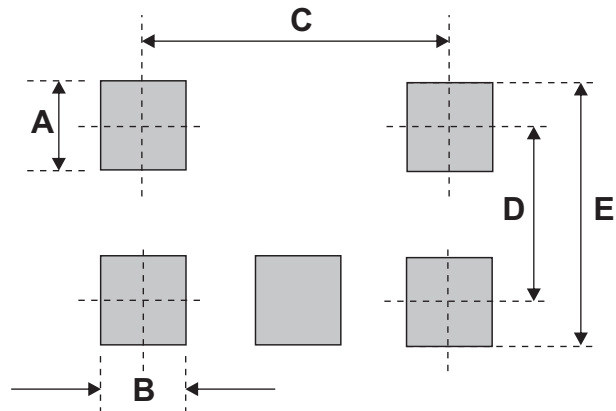

## Standard Packaging

| Case Type | REEL PACK    |                  |
|-----------|--------------|------------------|
|           | REEL ( pcs ) | Reel Size (inch) |
| SOT-23-5  | 3,000        | 7                |