

P6KE-HF Series

Stand-off Voltage: 6.8 ~ 600V

Power Dissipation: 600 Watts

RoHS Device

Halogen Free



Features

- 600W, surge capability at 1mS.
- Excellent clamping capability.
- Low leakage.
- Uni and Bidirectional unit.
- Very fast response time.

Mechanical Data

- Case: Molded plastic DO-15.
- Epoxy: UL 94V-0 rate flame retardant.
- Lead: Solderable per MIL-STD-202, method 208 guaranteed.
- Polarity: Color band denotes cathode end except Bipolar.
- Mounting position: Any.
- Weight: 0.402 grams.

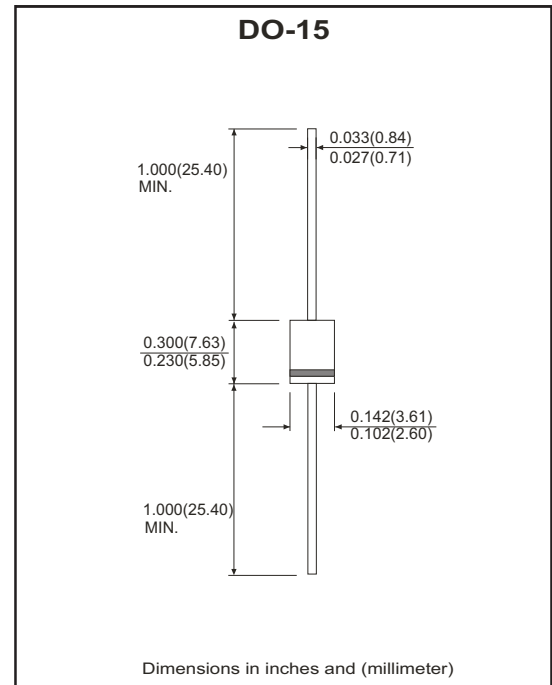

Maximum Ratings and Electrical Characteristics (at TA=25°C unless otherwise noted)

Parameter	Symbol	Value	Unit
Peak power dissipation with a 10/1000µs waveform(Note 1)	PPP	600	W
Peak pulse current with a 10/1000µs waveform (Note 1)	IPP	See Next Table	A
Power dissipation on infinite heatsink at TL=75°C	PD	5.0	W
Peak forward surge current, 8.3ms single half sine-wave unidirectional only (JEDEC method) (Note 2)	IFSM	100	A
Maximum instantaneous forward voltage at 50 A for unidirectional only(Note 3)	VF	3.5/5.0	V
Operating junction and storage temperature range	TJ, TSTG	-55 to +150	°C

NTOES:

(1) Non-repetitive current pulse, per fig.5 and derated above TA=25°C per fig. 1

(2) Measured on 8.3ms single half sine-wave or equivalent square wave, equare wave,duty cycle=4 pulses per minute maximum

(3) VF<3.5V for devices of VBR<200V and VF<5.0V for devices of VBR>201V

Rating and Characteristic Curves (P6KE-HF Series)

Fig.1- Pulse Derating Curve

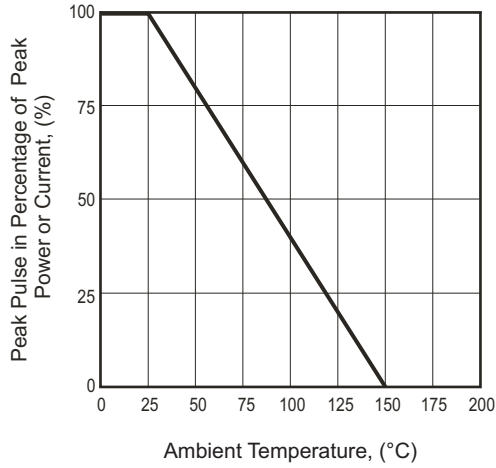

Fig.2- Maximum Non-Repetitive Surge Current

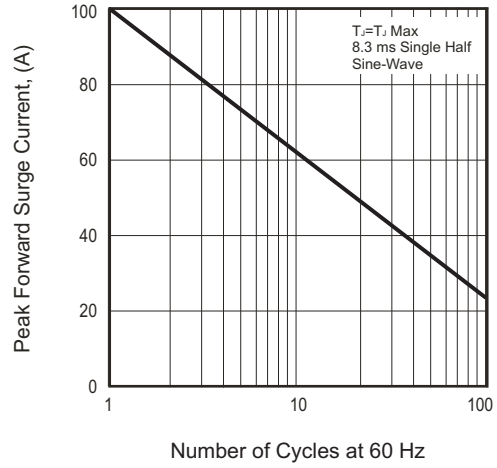

Fig.3- Steady State Power Derating Curve

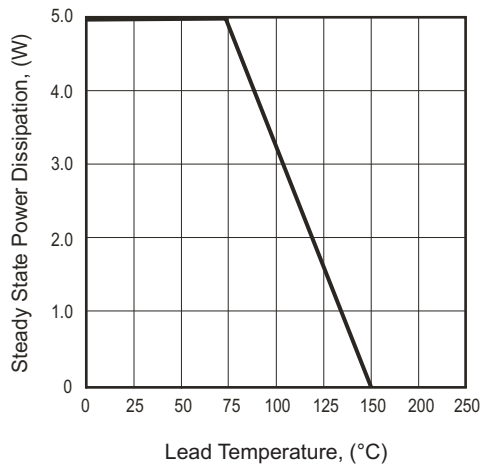

Fig.4- Peak Pulse Power Rating Curve

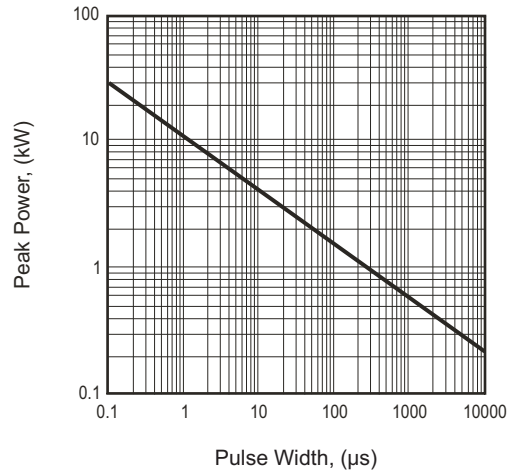

Fig.5- Pulse Waveform

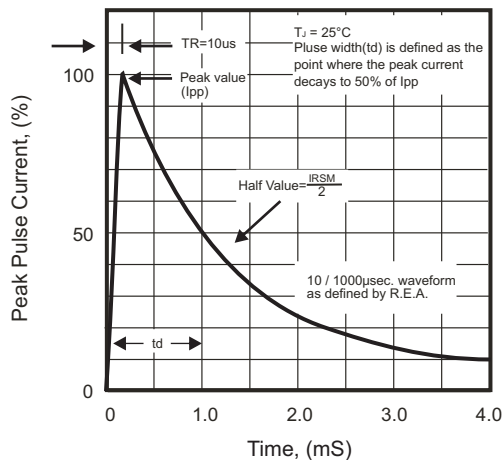
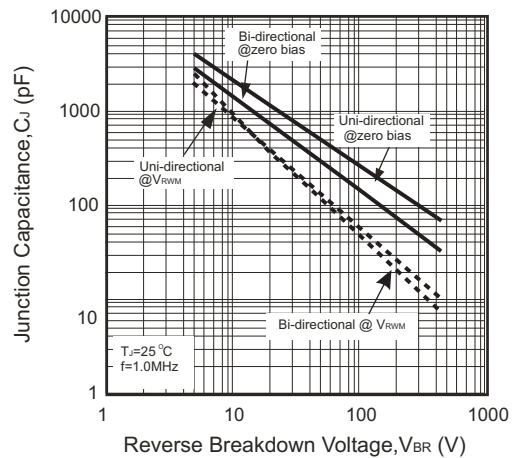

Fig.6 - Typical Junction Capacitance



600W Transient Voltage Suppressor



RATING AND CHARACTERISTIC (P6KE-HF Series)

Part No.		Absolute Maximum Rating (Ta=25°C)					Electrical Characteristics (Ta=25°C)				Marking Code.	
Uni	Bi	V _{RWM}	V _{BR} Min.	V _{BR} Max.	I _T	I _{FSM}	Max. Vc @I _{PPM}		Max. I _R @V _{RWM}	Uni	Bi	
		(V)	(V)	(V)	(mA)	(A)@8.3ms	(V)	I _{PPM} (A)	uA			
P6KE6.8A-HF	P6KE6.8CA-HF	5.8	6.46	7.14	10	100	10.5	57.14	1000	P6KE6.8A	P6KE6.8CA	
P6KE7.5A-HF	P6KE7.5CA-HF	6.4	7.13	7.88	10	100	11.3	53.10	500	P6KE7.5A	P6KE7.5CA	
P6KE8.2A-HF	P6KE8.2CA-HF	7.0	7.79	8.61	10	100	12.1	49.59	200	P6KE8.2A	P6KE8.2CA	
P6KE9.1A-HF	P6KE9.1CA-HF	7.8	8.65	9.56	1.0	100	13.4	44.78	50	P6KE9.1A	P6KE9.1CA	
P6KE10A-HF	P6KE10CA-HF	8.6	9.50	10.50	1.0	100	14.5	41.38	10	P6KE10A	P6KE10CA	
P6KE11A-HF	P6KE11CA-HF	9.4	10.45	11.55	1.0	100	15.6	38.46	5	P6KE11A	P6KE11CA	
P6KE12A-HF	P6KE12CA-HF	10.2	11.40	12.60	1.0	100	16.7	35.93	5	P6KE12A	P6KE12CA	
P6KE13A-HF	P6KE13CA-HF	11.1	12.35	13.65	1.0	100	18.2	32.97	1	P6KE13A	P6KE13CA	
P6KE15A-HF	P6KE15CA-HF	12.8	14.25	15.75	1.0	100	21.2	28.30	1	P6KE15A	P6KE15CA	
P6KE16A-HF	P6KE16CA-HF	13.6	15.20	16.80	1.0	100	22.5	26.67	1	P6KE16A	P6KE16CA	
P6KE18A-HF	P6KE18CA-HF	15.3	17.10	18.90	1.0	100	25.2	23.81	1	P6KE18A	P6KE18CA	
P6KE20A-HF	P6KE20CA-HF	17.1	19.00	21.00	1.0	100	27.7	21.66	1	P6KE20A	P6KE20CA	
P6KE22A-HF	P6KE22CA-HF	18.8	20.90	23.10	1.0	100	30.6	19.61	1	P6KE22A	P6KE22CA	
P6KE24A-HF	P6KE24CA-HF	20.5	22.80	25.20	1.0	100	33.2	18.07	1	P6KE24A	P6KE24CA	
P6KE27A-HF	P6KE27CA-HF	23.1	25.65	28.35	1.0	100	37.5	16.00	1	P6KE27A	P6KE27CA	
P6KE30A-HF	P6KE30CA-HF	25.6	28.50	31.50	1.0	100	41.4	14.49	1	P6KE30A	P6KE30CA	
P6KE33A-HF	P6KE33CA-HF	28.2	31.35	34.65	1.0	100	45.7	13.13	1	P6KE33A	P6KE33CA	
P6KE36A-HF	P6KE36CA-HF	30.8	34.20	37.80	1.0	100	49.9	12.02	1	P6KE36A	P6KE36CA	
P6KE39A-HF	P6KE39CA-HF	33.3	37.05	40.95	1.0	100	53.9	11.13	1	P6KE39A	P6KE39CA	
P6KE43A-HF	P6KE43CA-HF	36.8	40.85	45.15	1.0	100	59.3	10.12	1	P6KE43A	P6KE43CA	
P6KE47A-HF	P6KE47CA-HF	40.2	44.65	49.35	1.0	100	64.8	9.26	1	P6KE47A	P6KE47CA	
P6KE51A-HF	P6KE51CA-HF	43.6	48.45	53.55	1.0	100	70.1	8.56	1	P6KE51A	P6KE51CA	
P6KE56A-HF	P6KE56CA-HF	47.8	53.20	58.80	1.0	100	77.0	7.79	1	P6KE56A	P6KE56CA	
P6KE62A-HF	P6KE62CA-HF	53.0	58.90	65.10	1.0	100	85.0	7.06	1	P6KE62A	P6KE62CA	
P6KE68A-HF	P6KE68CA-HF	58.1	64.60	71.40	1.0	100	92.0	6.52	1	P6KE68A	P6KE68CA	
P6KE75A-HF	P6KE75CA-HF	64.1	71.25	78.75	1.0	100	103.0	5.83	1	P6KE75A	P6KE75CA	
P6KE82A-HF	P6KE82CA-HF	70.1	77.90	86.10	1.0	100	113.0	5.31	1	P6KE82A	P6KE82CA	
P6KE91A-HF	P6KE91CA-HF	77.8	86.45	95.55	1.0	100	125.0	4.80	1	P6KE91A	P6KE91CA	
P6KE100A-HF	P6KE100CA-HF	85.5	95.00	105.00	1.0	100	137.0	4.38	1	P6KE100A	P6KE100CA	
P6KE110A-HF	P6KE110CA-HF	96.0	104.50	115.50	1.0	100	152.0	3.95	1	P6KE110A	P6KE110CA	
P6KE120A-HF	P6KE120CA-HF	102.0	114.00	126.00	1.0	100	165.0	3.64	1	P6KE120A	P6KE120CA	
P6KE130A-HF	P6KE130CA-HF	111.0	123.50	136.50	1.0	100	179.0	3.35	1	P6KE130A	P6KE130CA	
P6KE150A-HF	P6KE150CA-HF	128.0	142.50	157.50	1.0	100	207.0	2.90	1	P6KE150A	P6KE150CA	
P6KE160A-HF	P6KE160CA-HF	136.0	152.00	168.00	1.0	100	219.0	2.74	1	P6KE160A	P6KE160CA	
P6KE170A-HF	P6KE170CA-HF	145.0	161.50	178.50	1.0	100	234.0	2.56	1	P6KE170A	P6KE170CA	
P6KE180A-HF	P6KE180CA-HF	154.0	171.00	289.00	1.0	100	246.0	2.44	1	P6KE180A	P6KE180CA	
P6KE200A-HF	P6KE200CA-HF	171.0	190.00	210.00	1.0	100	274.0	2.19	1	P6KE200A	P6KE200CA	
P6KE220A-HF	P6KE220CA-HF	185.0	209.00	231.00	1.0	100	328.0	1.83	1	P6KE220A	P6KE220CA	
P6KE250A-HF	P6KE250CA-HF	214.0	237.50	262.50	1.0	100	344.0	1.74	1	P6KE250A	P6KE250CA	
P6KE300A-HF	P6KE300CA-HF	256.0	285.00	315.00	1.0	100	414.0	1.45	1	P6KE300A	P6KE300CA	
P6KE350A-HF	P6KE350CA-HF	299.3	332.50	367.50	1.0	100	482.0	1.24	1	P6KE350A	P6KE350CA	
P6KE380A-HF	P6KE380CA-HF	324.9	361.00	399.00	1.0	100	524.4	1.14	1	P6KE380A	P6KE380CA	
P6KE400A-HF	P6KE400CA-HF	342.0	380.00	420.00	1.0	100	548.0	1.09	1	P6KE400A	P6KE400CA	
P6KE440A-HF	P6KE440CA-HF	376.2	418.00	462.00	1.0	100	607.2	0.99	1	P6KE440A	P6KE440CA	

Company reserves the right to improve product design , functions and reliability without notice.

REV:C

600W Transient Voltage Suppressor

RATING AND CHARACTERISTIC (P6KE-HF Series)

Part No.		Absolute Maximum Rating (Ta=25°C)					Electrical Characteristics (Ta=25°C)			Marking Code.	
Uni	Bi	V _{VRWM}	V _{BR} Min.	V _{BR} Max.	I _T	I _{FSM}	Max. V _C @I _{PPM}		Max. I _R @V _{VRWM}	Uni	Bi
		(V)	(V)	(V)	(mA)	(A)@8.3mS	(V)	I _{PPM} (A)	uA		
P6KE500A-HF	P6KE500CA-HF	427.5	475.00	525.00	1.0	100	690.0	0.87	1	P6KE500A	P6KE500CA
P6KE520A-HF	P6KE520CA-HF	444.6	494.00	546.00	1.0	100	717.6	0.84	1	P6KE520A	P6KE520CA
P6KE550A-HF	P6KE550CA-HF	470.3	522.50	577.50	1.0	100	759.0	0.79	1	P6KE550A	P6KE550CA
P6KE600A-HF	P6KE600CA-HF	513.0	570.00	630.00	1.0	100	828.0	0.72	1	P6KE600A	P6KE600CA

NOTES:

- Suffix 'A' denotes 5% tolerance device.
- Add suffix 'C' or 'CA' after part number to specify Bi-directional devices
- For Bi-Directional devices having V_R of 10 Volts and under, the I_R Limit is double

Taping Specification For Axial Lead Diodes

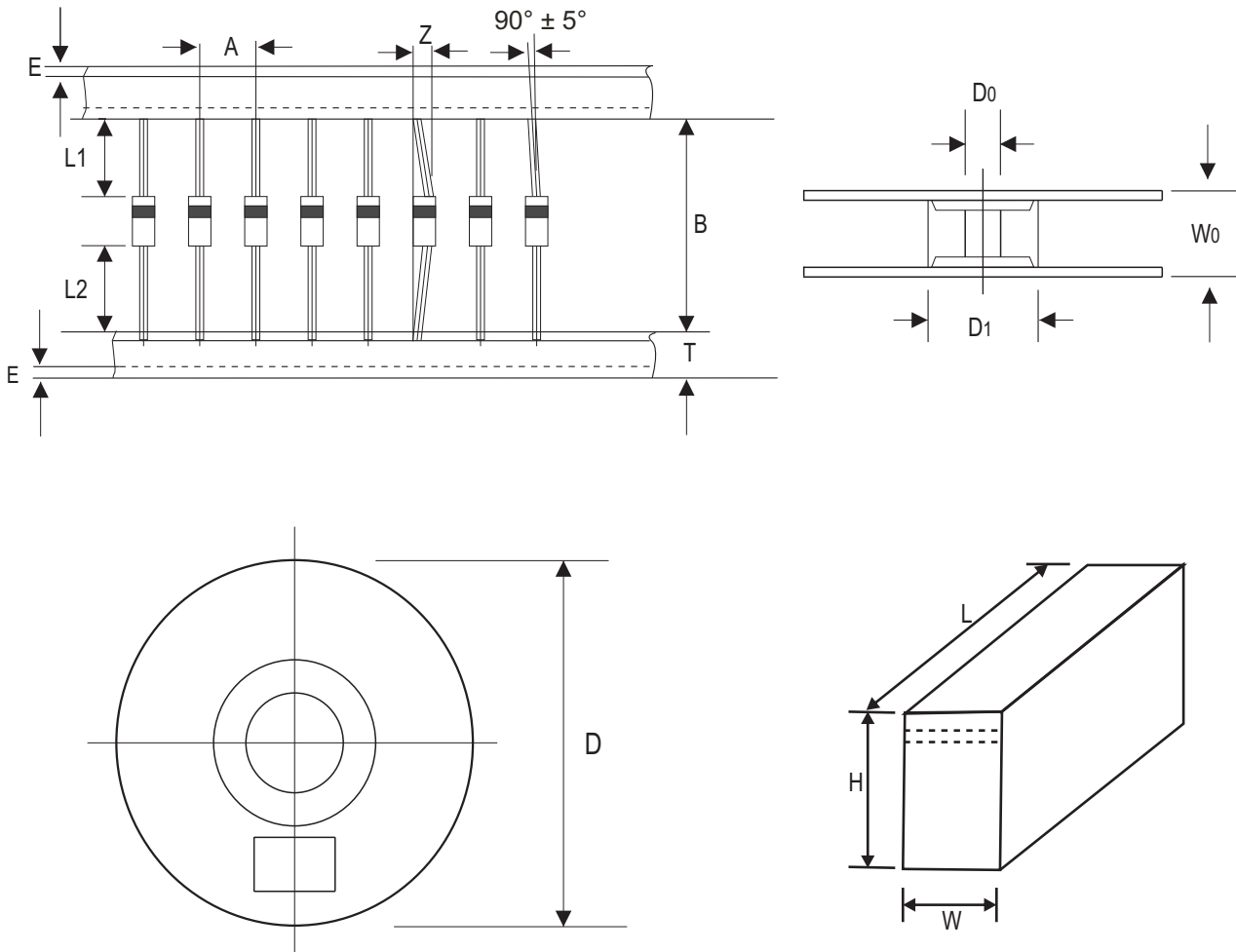

DO-15	SYMBOL	A	B	Z	T	E	L1	L2
	(mm)	5.00 ± 0.50	52.00 ± 0.50	1.20 (max)	6.00 ± 0.40	3.00 (max)	1.00 (max)	1.00 (max)
	(inch)	0.197 ± 0.020	2.047 ± 0.020	0.047 (max)	0.236 ± 0.016	0.118 (max)	0.039 (max)	0.039 (max)

DO-15	SYMBOL	D1	D0	D	W0	L	W	H
	(mm)	85.70 ± 0.30	16.60 ± 0.40	330.00	72.00 ± 3.00	260.00	75.00	145.00
	(inch)	3.374 ± 0.012	0.654 ± 0.016	13.000	2.835 ± 0.118	10.236	2.953	5.709

Standard Packaging

Case Type	AMMO PACK	
	BOX (pcs)	CARTON (pcs)
DO-15	3,000	30,000

Company reserves the right to improve product design , functions and reliability without notice.

REV:C