

TV50C110-G Thru. TV50C441-G

Working Peak Reverse Voltage: 11 to 440 Volts

Power Dissipation: 5000 Watts

RoHS Device

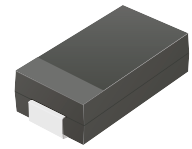

Features

- Glass passivated chip.
- 5000W peak pulse power capability with a 10/1000 μ s waveform, repetitive rate (duty cycle): 0.01%.
- Low leakage.
- Excellent clamping capability.
- Very fast response time.

Mechanical data

- Case: DO-214AB(SMC), molded plastic.
- Terminals: solderable per MIL-STD-750, method 2026.
- Polarity: Color band denotes cathode end.
- Approx. weight: 0.21 grams

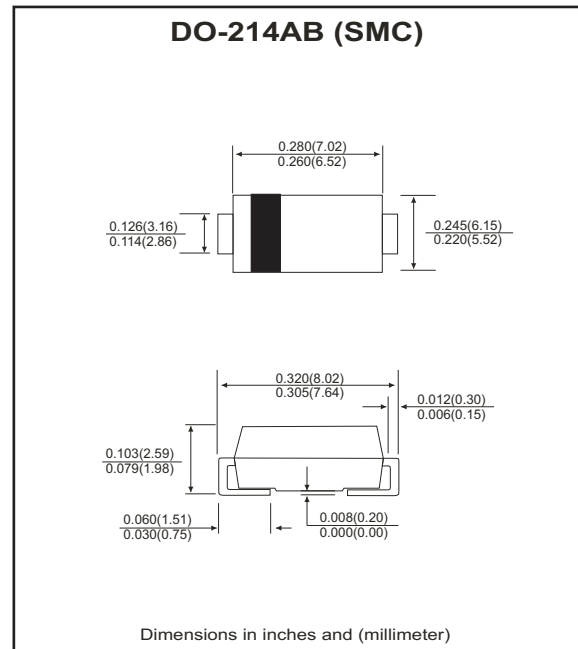

Maximum Ratings and Electrical Characteristics

Ratings at 25°C ambient temperature unless otherwise specified.
Single phase, half wave, 60Hz, resistive or inductive load.
For capacitive load, derate current by 20%.

Characteristics	Symbol	Value	Units
Peak power dissipation with a 10/1000 μ S waveform	P _{PP}	5000	W
Peak pulse current on 10/1000 μ S waveform	I _{PP}	See Next Table	A
Power dissipation on infinite heatsink at T _L =75 °C	P _D	6.5	W
Peak forward surge current, 8.3ms single half sine-wave uni-directional only (Note 2)	I _{FSM}	300	A
Maximum instantaneous forward voltage at 100A for uni-directional only (Note 3)	V _F	3.5/5.0	V
Operating junction temperature	T _J	-55 to +150	°C
Storage temperature range	T _{STG}	-55 to +150	°C

Notes:

1. Non-Repetitive Current pulse per Fig.5 and derated above T_A=25°C per Fig .1
2. Measured on 8.3ms single half sine-wave or equivalent square wave, duty cycle=4 pulses per maximum per minute maximum.
3. V_F<3.5V for devices of V_{BR} <200V and V_F <5.0V for devices of V_{BR}>201V

RATING AND CHARACTERISTIC CURVES (TV50C110-G thru TV50C441-G)

Fig.1 Pulse Derating Curve

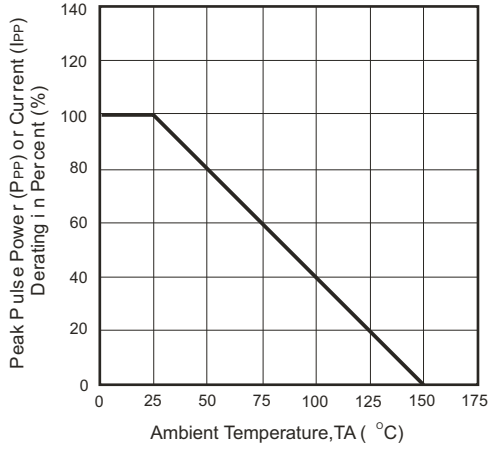

Fig.2 Maximum Non-Repetitive Surge Current

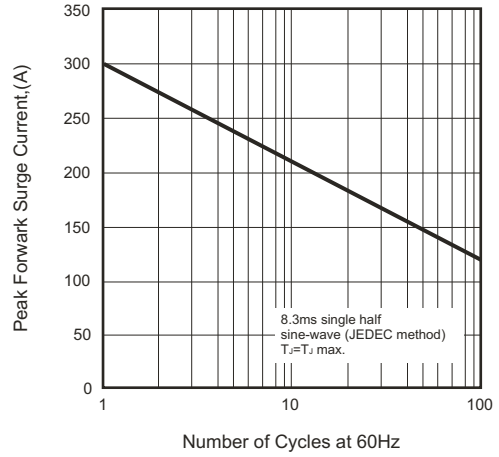

Fig.3 Steady State Power Derating Curve

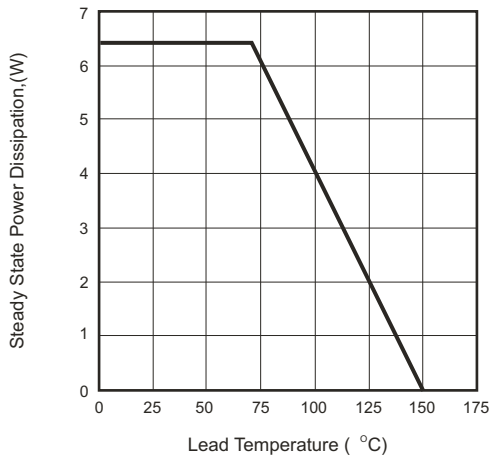

Fig.4 Peak Pulse Power Rating Curve

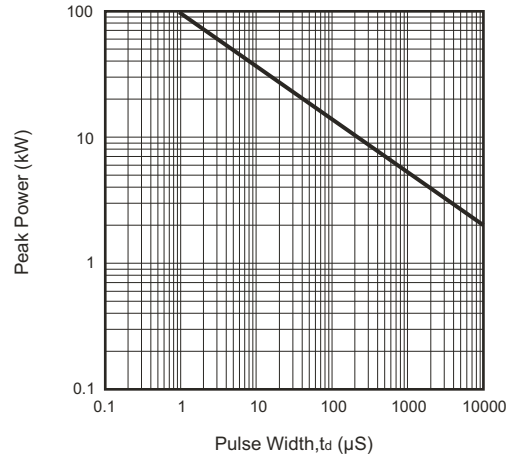

Fig.5 Pulse Waveform

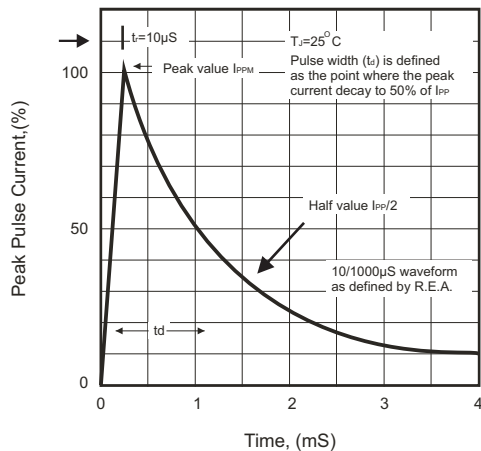
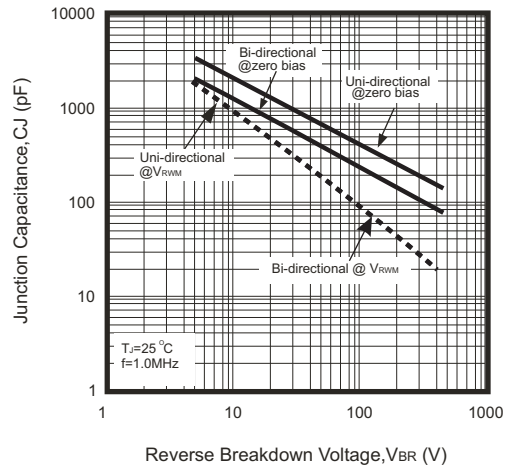

Fig.6 Typical Junction Capacitance



SMD Transient Voltage Suppressor

Electrical Characteristics (TV50C110-G Thru. TV50C441-G)

Part No	Absolute Maximum Rating(Ta=25°C)					Electrical Characteristic(Ta=25°C)				
	V _{RWM}	V _{BR} Min	V _{BR} Max	I _T	I _{FSM}	MAX V _C	I _R @V _{RWM}	Marking Code		
	(V)	(V)	(V)	(mA)	(A)@8.3ms	(V)	IPP(A)	(µA)	UNI	BI
TV50C110J(B)-G	11.0	12.20	13.50	1	300	18.2	277.47	800	5PDX	5BDX
TV50C120J(B)-G	12.0	13.30	14.70	1	300	19.9	253.77	800	5PDZ	5BDZ
TV50C130J(B)-G	13.0	14.40	15.90	1	300	21.5	234.88	500	5PEE	5BEE
TV50C140J(B)-G	14.0	15.60	17.20	1	300	23.2	217.67	200	5PEG	5BEG
TV50C150J(B)-G	15.0	16.70	18.50	1	300	24.4	206.97	100	5PEK	5BEK
TV50C160J(B)-G	16.0	17.80	19.70	1	300	26.0	194.23	50	5PEM	5BEM
TV50C170J(B)-G	17.0	18.90	20.90	1	300	27.6	182.97	20	5PEP	5BEP
TV50C180J(B)-G	18.0	20.00	22.10	1	300	29.2	172.95	10	5PER	5BER
TV50C190J(B)-G	19.0	21.10	23.30	1	300	30.8	164.07	10	5PET	5BET
TV50C200J(B)-G	20.0	22.20	24.50	1	300	32.4	155.86	5	5PEV	5BEV
TV50C220J(B)-G	22.0	24.40	26.90	1	300	35.5	142.25	5	5PEX	5BEX
TV50C240J(B)-G	24.0	26.70	29.50	1	300	38.9	129.82	5	5PEZ	5BEZ
TV50C260J(B)-G	26.0	28.90	31.90	1	300	42.1	119.95	5	5PFE	5BFE
TV50C280J(B)-G	28.0	31.10	34.40	1	300	45.4	111.23	5	5PFG	5BFG
TV50C300J(B)-G	30.0	33.30	36.80	1	300	48.4	104.34	5	5PFK	5BFK
TV50C330J(B)-G	33.0	36.70	40.60	1	300	53.3	94.75	5	5PFM	5BFM
TV50C360J(B)-G	36.0	40.00	44.20	1	300	58.1	86.92	5	5PFP	5BFP
TV50C400J(B)-G	40.0	44.40	49.10	1	300	64.5	78.29	5	5PFR	5BFR
TV50C430J(B)-G	43.0	47.80	52.80	1	300	69.4	72.77	5	5PFT	5BFT
TV50C450J(B)-G	45.0	50.00	55.30	1	300	72.7	69.46	5	5PFV	5BFV
TV50C480J(B)-G	48.0	53.30	58.90	1	300	77.4	65.25	5	5PFX	5BFX
TV50C510J(B)-G	51.0	56.70	62.70	1	300	82.4	61.29	5	5PFZ	5BFZ
TV50C540J(B)-G	54.0	60.00	66.30	1	300	87.1	57.98	5	5PGE	5BGE
TV50C580J(B)-G	58.0	64.40	71.20	1	300	93.6	53.95	5	5PGG	5BGG
TV50C600J(B)-G	60.0	66.70	73.70	1	300	96.8	52.17	5	5PGK	5BGK
TV50C640J(B)-G	64.0	71.10	78.60	1	300	103.0	49.03	5	5PGM	5BGM
TV50C700J(B)-G	70.0	77.80	86.00	1	300	113.0	44.69	5	5PGP	5BGP
TV50C750J(B)-G	75.0	83.30	92.10	1	300	121.0	41.74	5	5PGR	5BGR
TV50C780J(B)-G	78.0	86.70	95.80	1	300	126.0	40.08	5	5PGT	5BGT
TV50C800J(B)-G	80.0	88.80	97.60	1	300	129.6	38.97	5	5PGB	5BGB
TV50C850J(B)-G	85.0	94.40	104.00	1	300	137.0	36.86	5	5PGV	5BGV
TV50C900J(B)-G	90.0	100.00	111.00	1	300	146.0	34.59	5	5PGX	5BGX
TV50C101J(B)-G	100.0	111.00	123.00	1	300	162.0	31.17	5	5PGZ	5BGZ
TV50C111J(B)-G	110.0	122.00	135.00	1	300	177.0	28.53	5	5PHE	5BHE
TV50C121J(B)-G	120.0	133.00	147.00	1	300	193.0	26.17	5	5PHG	5BHG
TV50C131J(B)-G	130.0	144.00	159.00	1	300	209.0	24.16	5	5PHK	5BHK
TV50C141J(B)-G	140.0	155.00	171.00	1	300	226.8	22.27	5	5PHB	5BHB
TV50C151J(B)-G	150.0	167.00	185.00	1	300	243.0	20.78	5	5PHM	5BHM
TV50C161J(B)-G	160.0	178.00	197.00	1	300	259.0	19.50	5	5PHP	5BHP
TV50C171J(B)-G	170.0	189.00	209.00	1	300	275.0	18.36	5	5PHR	5BHR
TV50C181J(B)-G	180.0	200.00	220.00	1	300	291.6	17.32	5	5PHT	5BHT
TV50C191J(B)-G	190.0	211.00	232.00	1	300	307.8	16.41	5	5PHV	5BHV
TV50C221J(B)-G	220.0	246.00	272.00	1	300	356.0	8.43	5	5PHX	5BHX
TV50C301J(B)-G	300.0	335.00	371.00	1	300	486.0	6.17	5	5PJE	5BJE
TV50C401J(B)-G	400.0	447.00	494.00	1	300	648.0	4.63	5	5PJK	5BJK
TV50C441J(B)-G	440.0	492.00	543.00	1	300	713.0	4.21	5	5PJM	5BJM

Note:

- 1) Suffix J denotes 5% tolerance devices.
- 2) Suffix B after part number to specify Bi-directional devices.
- 3) For Bi-Directional devices having V_R of 10 volts and under, the I_R limit is double.

Reel Taping Specification

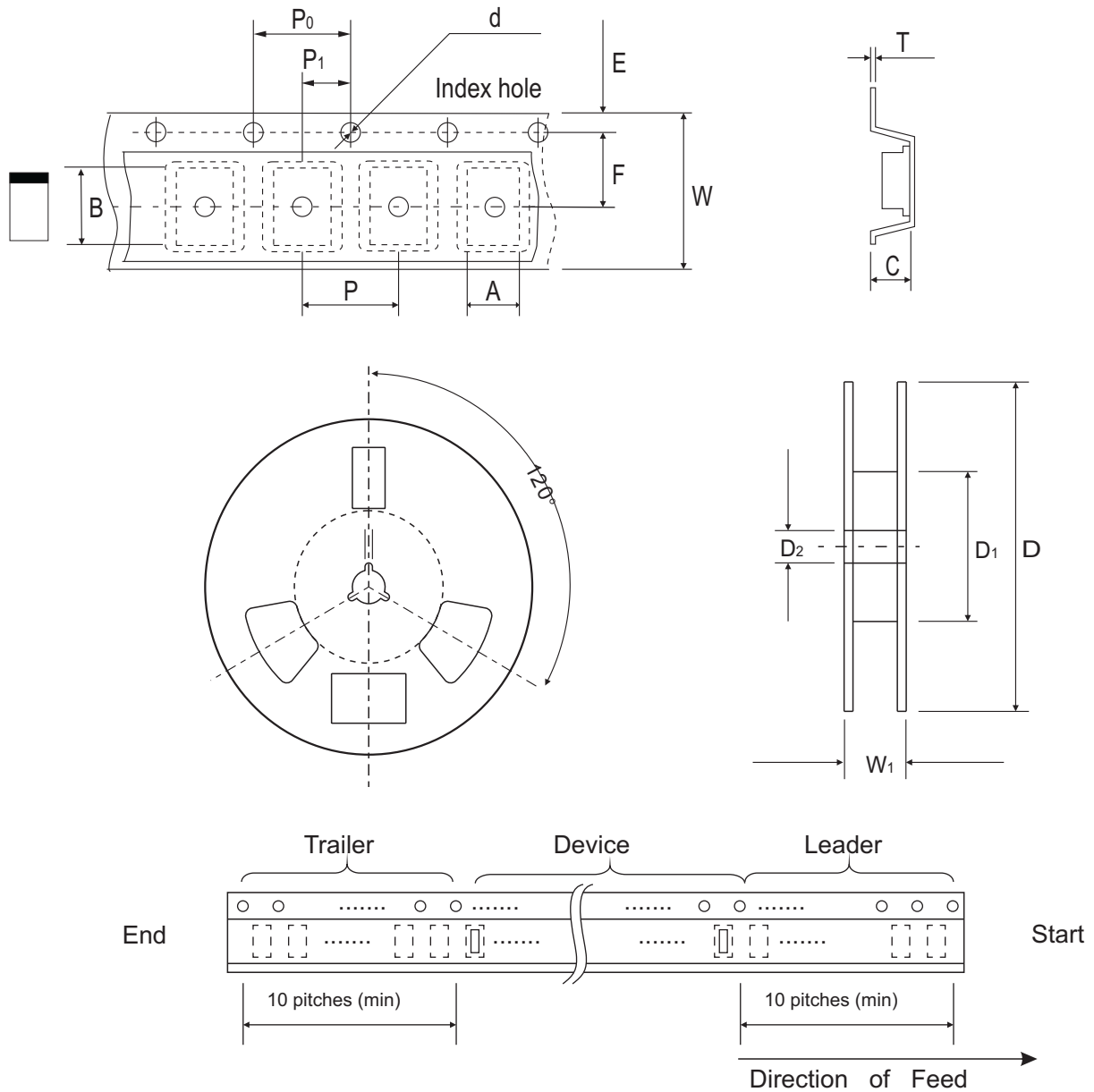

DO-214AB (SMC)	SYMBOL	A	B	C	d	D	D1	D2
	(mm)	6.05 ± 0.10	8.31 ± 0.10	4.50 (max)	1.55 ± 0.10-0.0	330	50.0 MIN.	13.0 ± 0.20
	(inch)	0.256 ± 0.004	0.327 ± 0.004	0.177 (max)	0.061 ± 0.004	13.00	1.969 MIN.	0.512 ± 0.008

DO-214AB (SMC)	SYMBOL	E	F	P	P0	P1	W	W1
	(mm)	1.75 ± 0.10	7.50 ± 0.05	4.00 ± 0.10	4.00 ± 0.10	2.00 ± 1.00	16.0 ± 0.30	22.4 MAX.
	(inch)	0.069 ± 0.004	0.295 ± 0.002	0.157 ± 0.004	0.157 ± 0.004	0.079 ± 0.040	0.630 ± 0.012	0.882 MAX.

Marking Code



1. XXXX : Marking code(see Page. 3~4)
2. : Cathod Band

Suggested PAD Layout

SIZE	DO-214AB(SMC)	
	(mm)	(inch)
A	6.61	0.260
B	1.52	0.060
C	3.20	0.126
D	8.13	0.320
E	4.69	0.185

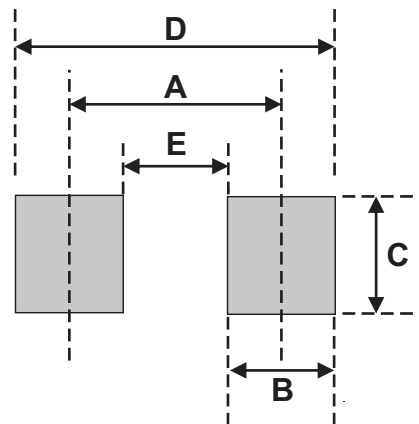

Standard Packaging

Case Type	Qty Per Reel	Reel Size
	(Pcs)	(inch)
DO-214AB (SMC)	3,000	13