

CURA101-G Thru. CURA107-G

Reverse Voltage: 50 to 1000 Volts

Forward Current: 1.0 Amp

RoHS Device

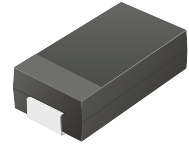

Features

- Ideal for surface mount applications.
- Easy pick and place.
- Plastic package has Underwriters Lab. flammability classification 94V-0.
- Ultra fast recovery time: 50~75nS.
- Low leakage current.

Mechanical data

- Case: JEDEC DO-214AC, molded plastic.
- Terminals: solderable per MIL-STD-750, method 2026.
- Polarity: Color band denotes cathode end.
- Approx. weight: 0.063 grams

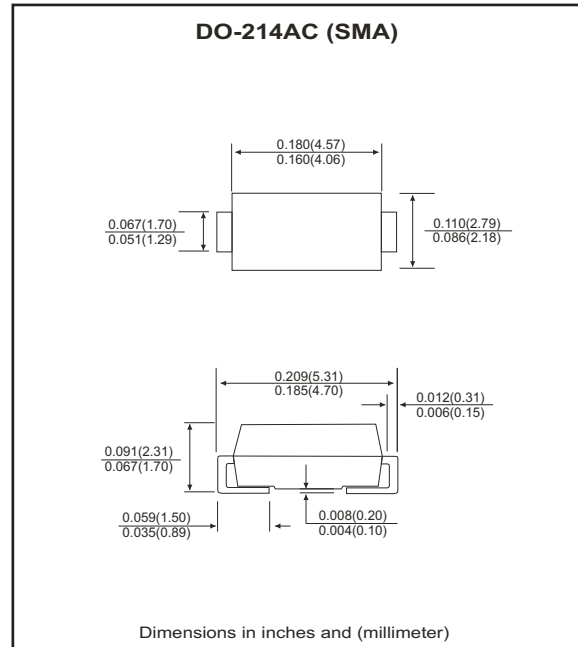

Maximum Ratings and Electrical Characteristics

Parameter	Symbol	CURA 101-G	CURA 102-G	CURA 103-G	CURA 104-G	CURA 105-G	CURA 106-G	CURA 107-G	Units
Max. repetitive peak reverse voltage	V_{RRM}	50	100	200	400	600	800	1000	V
Max. DC blocking voltage	V_{DC}	50	100	200	400	600	800	1000	V
Max. RMS voltage	V_{RMS}	35	70	140	280	420	560	700	V
Peak surge forward current, 8.3ms single half sine-wave superimposed on rate load (JEDEC method)	I_{FSM}	30							A
Max. average forward current	I_o	1.0							A
Max. instantaneous forward voltage at 1.0A	V_F	1.0			1.3	1.7			V
Reverse recovery time	T_{rr}	50				75			nS
Max. DC reverse current at $T_A=25^{\circ}C$ rated DC blocking voltage $T_A=100^{\circ}C$	I_R					5.0	100		μA
Max. thermal resistance (Note 1)	$R_{\theta JL}$					42			$^{\circ}C/W$
Max. operating junction temperature	T_J					150			$^{\circ}C$
Storage temperature	T_{STG}					-55 to +150			$^{\circ}C$

Notes: 1. Thermal resistance from junction to lead.

RATING AND CHARACTERISTIC CURVES (CURA101-G thru CURA107-G)

Fig.1 Reverse Characteristics

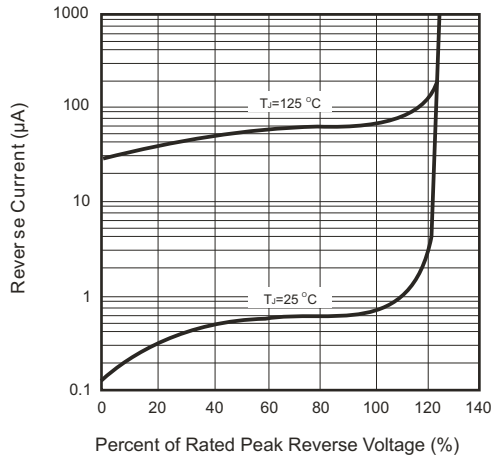

Fig.2 Forward Characteristics

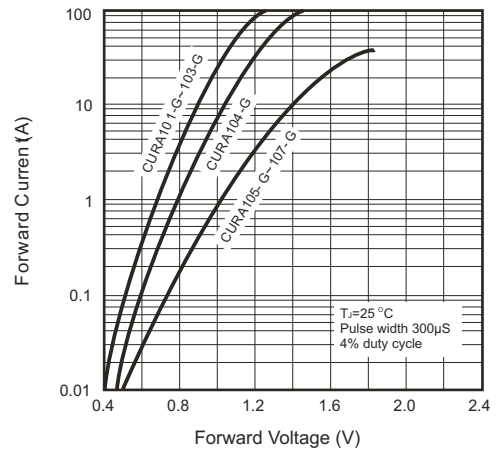

Fig.3 Junction Capacitance

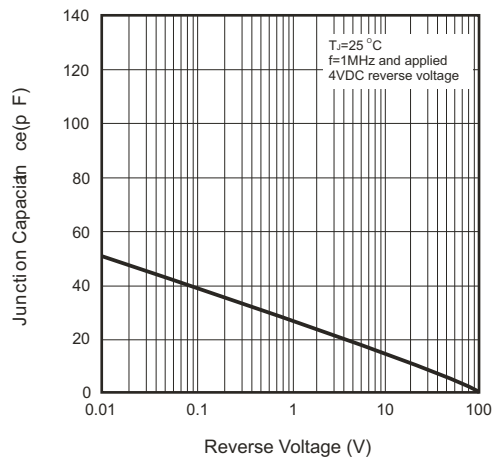

Fig.4 Non-repetitive Forward Surge Current

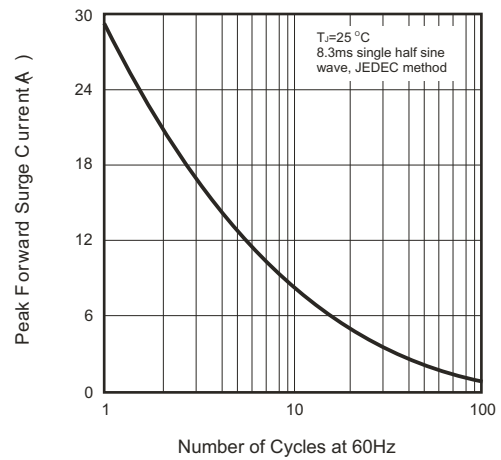

Fig.5 Test Circuit Diagram and Reverse Recovery Time Characteristics

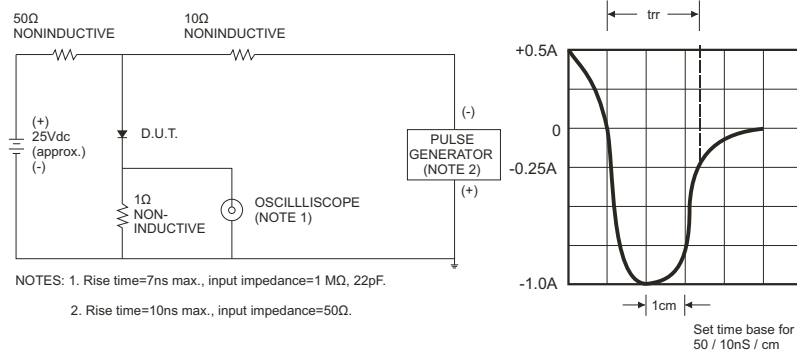

Fig.6 Current Derating Curve

